

AMBIFLEX



GUARANTEE

The standard lenses for the Agfaflex have been specially computed and manufactured in accordance with the very latest scientific methods to suit this type of camera.

The Agfa Color-Solinar f/2.8 is a 4-element, anastigmat lens, of brilliant definition and high resolving power. The Agfa Color-Solagon with an aperture of f/2.0 is a high performance lens which is supreme in the 6-element lens class.

Apart from this, both lenses are notable for their outstanding reproduction of detail and good colour correction. A combination of these attributes makes them the ideal lenses for miniature photography with black and white or colour film.

In addition, every lens leaving our factory is tested by the most up-to-date methods and is guaranteed for its quality and performance.

AGFA AKTIENGESELLSCHAFT
Camera-Werk Muenchen

AGFA AMBIFLEX I (see Fig. A)

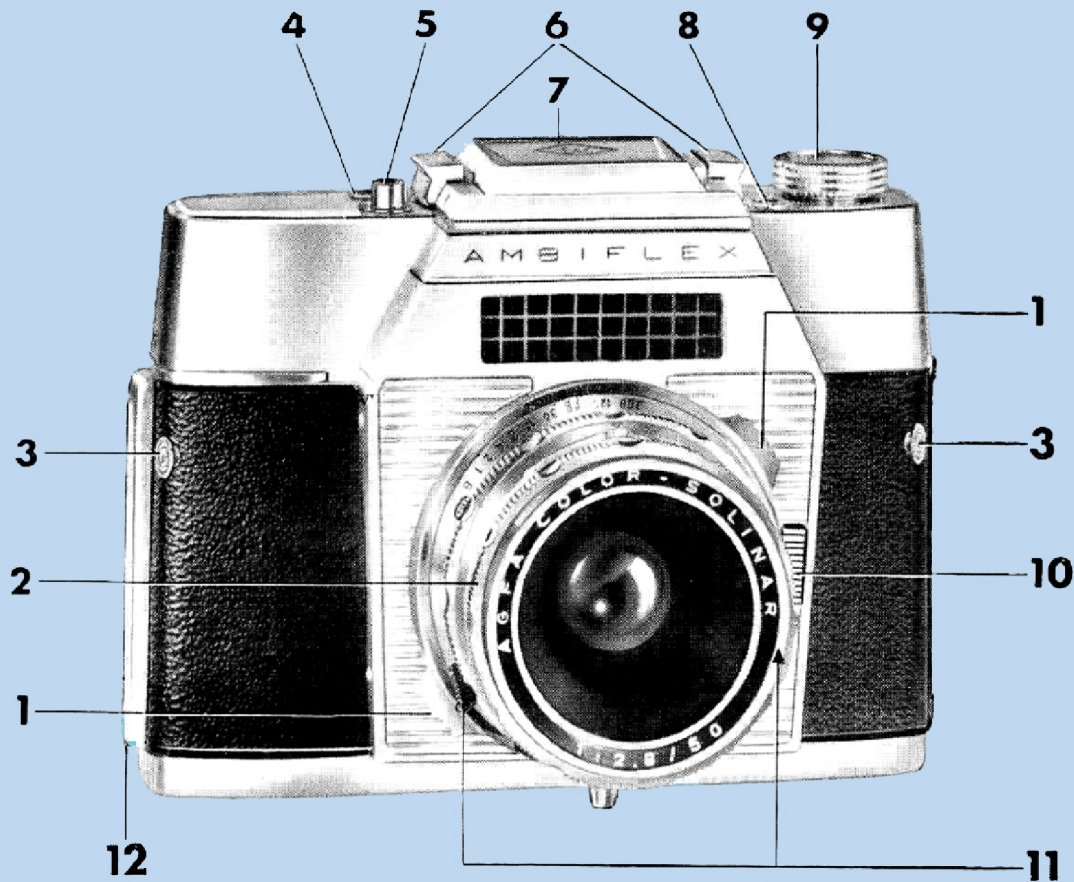

- 1 Setting buttons for shutter speeds
- 2 Focusing ring
- 3 Carrying strap studs
- 4 Window for exposure meter pointer
- 5 Shutter release threaded for cable
- 6 Release grips for changing the viewfinder

AGFA AMBIFLEX II (same equipment but with prism viewfinder)

Fig. A

- 7 Waist-level hood viewfinder
- 8 Flash contact
- 9 Rewind knob with film type indicator
- 10 Lens release button
- 11 Two aperture setting buttons
- 12 Catch for camera back
- 13 Prism viewfinder

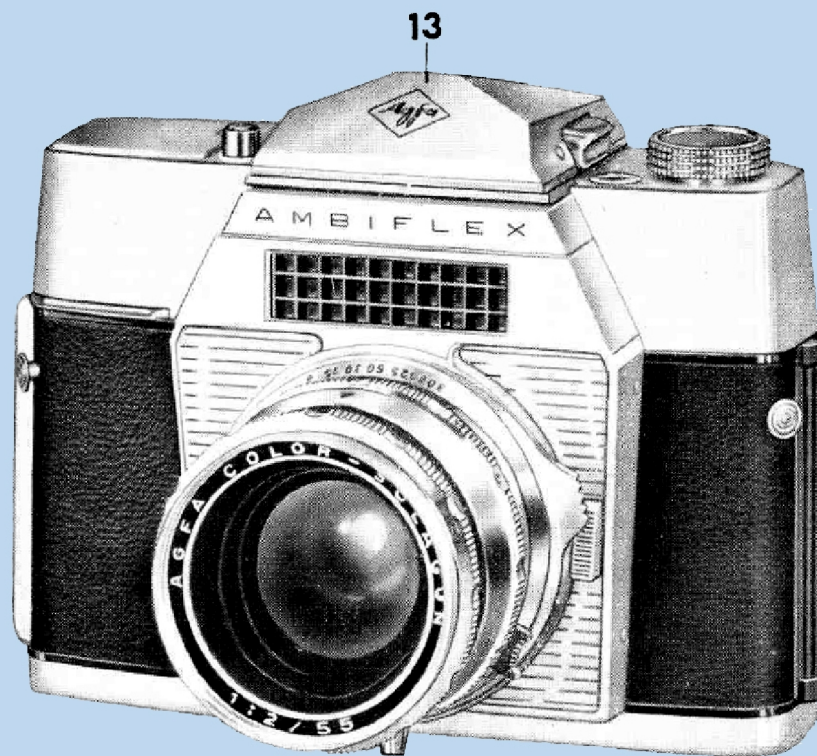

Fig. B

AGFA AMBIFLEX III (see Fig. B)

WITH YOUR NEW AGFA AMBIFLEX

you can be sure of taking perfect photographs and you are to be congratulated on your choice.

The operational convenience, wide range of accessories and uncomplicated handling characteristics of the reflex camera with its interchangeable lenses make it easy for you to take the most excellent photographs.

Your Agfa Ambiflex offers you the following special advantages:

Agfa interchangeable high-performance lenses • Pre-set iris diaphragm • Choice of waist-level or prism viewfinder • Exact demarcation of picture area on ground glass screen • Split-image rangefinder in viewfinder for all lenses • Automatic exposure control mechanism.

Your photographic dealer may have explained the Ambiflex to you, but before using your new camera for the first time we suggest that you read through this little booklet to familiarize yourself with the various manual operations. Afterwards you need only refer to the blue dots in each section which cover the main points in brief.

And now we wish you many happy hours of relaxation. We feel confident that you will enjoy photography with this camera to the full, due in large measure to its bright, clear viewfinder which makes the task of selecting the subject a real joy.

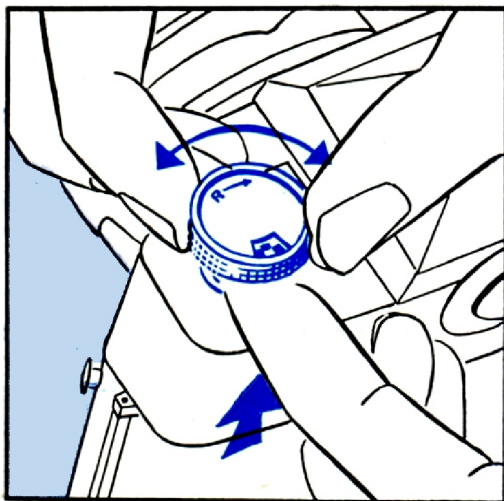

When loading a colour reversal film (for colour transparencies) you should use one of the following settings: ►

Set the required symbol by turning the knob, holding it by its lower milled disk.

FILM TYPE INDICATOR

This reminds you of the type of film in your camera. If your photographic dealer has already loaded the camera for you, check the indicator immediately. Should it not yet have been set pull out the rewinding knob and set the required film type in the window by means of the milled ring under the knob (see illustration).

If, for example, a **black-and-white film** is to be loaded, this is indicated by setting the black and white sectors in the window of the reminder disk. If you are using colour negative film, provision is made for the following setting:

- CN = Colour negative film for daylight and artificial light
- CT = Colour reversal film, daylight type
- DAY = Colour reversal film, daylight type
- CK = Colour reversal film, artificial light type
- A (incandescent lamps of 3400° Kelvin)
- CF = Colour reversal film, artificial flashlight
- F type (3800° Kelvin)

The remaining designations apply to other than English speaking countries.

COMPARATIVE FILM SPEEDS

DIN/ASA SCALE

To ensure that the built-in exposure meter is adjusted to the speed of the film in the camera it is necessary to set the appropriate figure on the shutter before making the exposure.

Between the shutter speed ring and the aperture ring you will see a small key indicated by an arrow in the illustration. This key is depressed and the other hand used to turn the aperture setting ring until the black mark is opposite the appropriate DIN/ASA number.

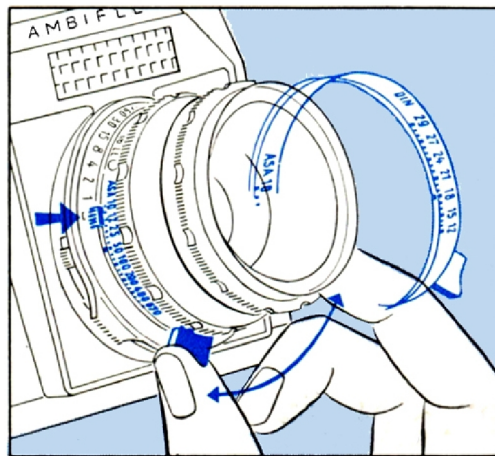

Press in key, turn aperture ring until DIN/ASA number is opposite black mark.



DIN	ASA	Scheiner	Weston	G.E.
10°	8	20°	6	10
11°	10	21°	8	12
12°	12	22°	10	16
13°	16	23°	12	20
14°	20	24°	16	25
15°	25	25°	20	32
16°	32	26°	25	40
17°	40	27°	32	50
18°	50	28°	40	64
19°	64	29°	50	80
20°	80	30°	64	100
21°	100	31°	80	125
22°	125	32°	100	160
23°	160	33°	125	200
24°	200	34°	160	250
25°	250	35°	200	320
26°	320	36°	250	400
27°	400	37°	320	500
28°	500	38°	400	640
29°	640	39°	500	800

FILM COUNTER

indicates the number of exposures you still have left on the film.

After loading the camera, the film counter at the lower edge of the camera back should be set to the starting position.

To do this, turn the milled ring in the direction of the arrow (see illustration) so that the fixed mark is opposite the green

triangle. When using a cassette with 36 exposures this is done by setting the scale to the green triangle between 36 and 0, for films with 20 exposures the green triangle between 25 and 20. When loading the camera the start of the film is wasted by exposure to light and so you must first make two blank exposures. This is done by operating the rapid transport lever (see page 5).

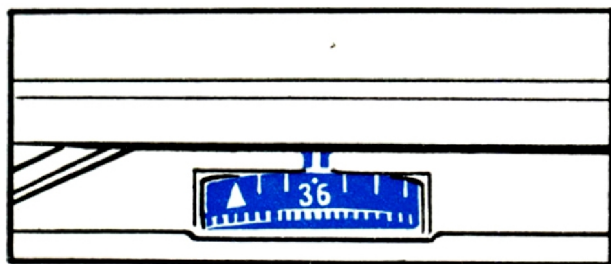

Turn milled ring until green triangle is opposite fixed mark on the body.

FILM TRANSPORT

The rapid transport lever moves the film on one frame each time it is operated. Place your thumb behind this lever and swivel it round as far as possible (see illustration). If the lever is blocked you will have to press the shutter release first. You should repeat this operation of film transport and shutter release until the number 36 or 20 is opposite the fixed index mark (see illustration page 4). Your camera is then ready for use. If you inadvertently release the rapid transport lever only half way you must take hold of it again and complete the movement.

Caution! Usually the rewinding knob turns as the film is transported and should therefore not be hindered in any way.



Swing lever to stop, film is advanced by one frame.

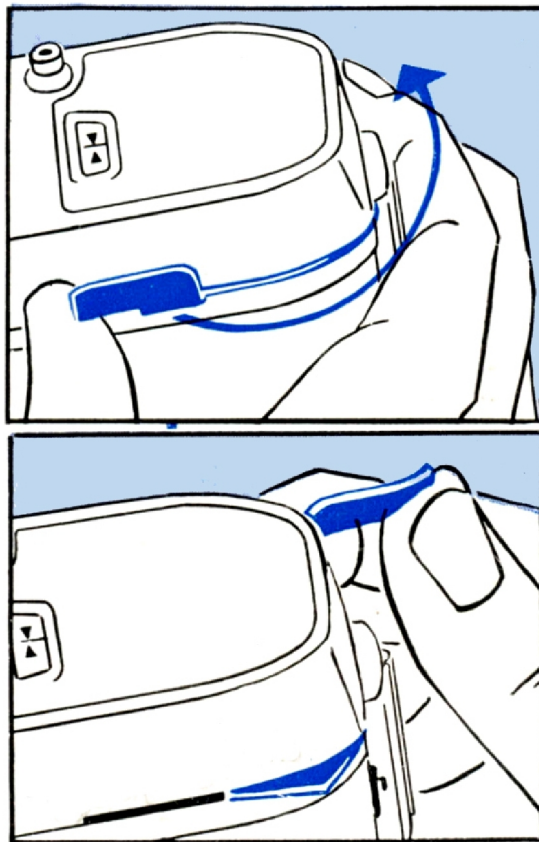

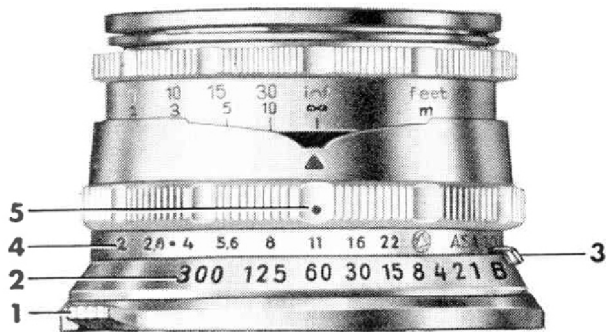

- 1 Buttons for setting shutter speed
- 2 Shutter speed scale
- 3 Pressure key for setting film speed (DIN/ASA)
- 4 Aperture scale
- 5 Setting mark for shutter speed and aperture
(Shutter speeds should engage in their click stops directly opposite the mark.)

WHAT YOU NEED TO KNOW...

Lighting conditions are subject to considerable variations. This is why your camera is fitted with different shutter speeds and apertures of varying size. With both these means you can adjust the camera to suit the particular light and subject.

THE SHUTTER

has been built into the camera body; shutter speed values are engraved on the setting ring which is turned by the buttons ① on the right and left to bring the required shutter speed opposite the setting mark.

THE DIAPHRAGM

is incorporated in every Ambiflex lens; its values are also engraved on the setting ring (4, see illustration page 6) and can be set by means of the two black buttons. The *pre-set iris diaphragm* on the Ambiflex permits selection of the subject at the largest aperture—no matter which stop has been chosen. Only when the shutter release is operated does the aperture automatically spring to the previously set value. Subsequent transport of the film opens up the aperture again so that full benefit is derived from the speed of the lens in the viewfinder image.

As only a limited amount of light should be allowed to reach the film, depending on its speed, it is necessary that the right combination of shutter speed and aperture be used for each photograph.

This is where the **built-in exposure meter** comes to your assistance; it is independently coupled to both the aperture setting ring and to the shutter speed setting ring.

First make sure that you have set the speed of the film on the scale as described.



The built-in exposure meter facilitates the selection of the correct shutter speed—aperture combination.

...AND HOW TO DO IT

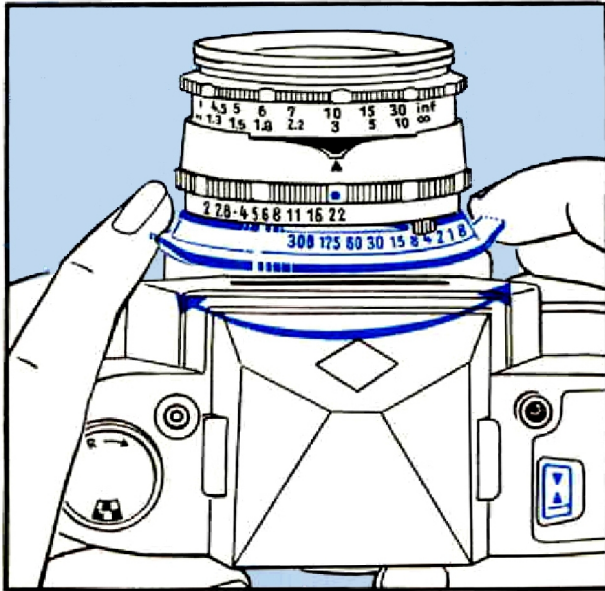

First set a suitable shutter speed opposite the black dot by turning the shutter speed ring by means of its buttons.

1. Shutter speed

First set a shutter speed suited to the particular subject; but note that for fast moving objects a fast shutter speed should be used (e.g. $\frac{1}{125}$ sec., see illustration). Photographs without a tripod should only be taken with shutter speeds of $\frac{1}{60}$ to $\frac{1}{250}$ sec.

2. Light reading

Point the camera at the subject so that reflected light from it reaches the photoelectric cell through the exposure meter window.

Caution! Do not cover the window of the photoelectric cell with your finger when measuring the light.

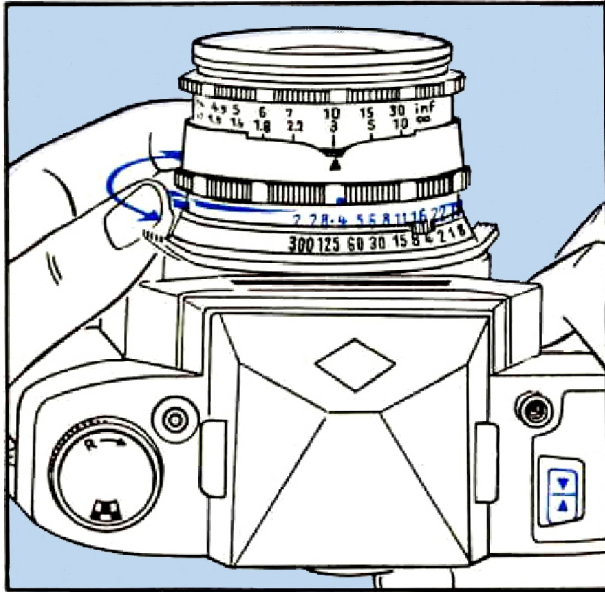

Turn aperture ring until exposure meter pointer is centred on the setting mark.

Now adjust the exposure meter pointer in its window on top of the camera to the centre of the setting mark by turning the aperture setting ring (see illustration).

3. Correct reading

As soon as the exposure meter pointer is centred on the setting mark this gives the correct aperture corresponding to the



previously selected shutter speed. In our illustration, for instance, $1/125$ sec. and $f/4$.

Just press down the shutter release as described on pages 25 to 27, and you have taken your first photo. If you are unable to centre the pointer on the mark –because the milled ring has reached the stop at the right or left–this means you have set a shutter speed which is either too fast or too slow for the lighting conditions. In such cases select a new shutter speed and repeat the procedure.

You can naturally select the aperture too –if you require a particular depth-of-field zone (see chapter “Depth of Field”, pages 29–31)–and by moving the shutter speed ring you can centre the exposure meter pointer on the setting mark. Since, however, the shutter speed ring can only be adjusted to the engraved click stop settings it may not be possible to centre the

exposure meter pointer exactly on the setting mark.

In such cases a slight correction by means of the aperture ring may be necessary.



If a certain depth-of-field zone is required first select the aperture and centre exposure meter pointer on setting mark by means of the shutter speed ring.

A FEW HINTS ON EXPOSURE CALCULATION

With landscape photographs the sky usually occupies a considerable part of the picture. Apart from a few rare exceptions, the sky is brighter than the main part of the subject and so it is better to aim the camera at the dark part. If brightness contrast of the subject is particularly great, you will have to decide which parts must be reproduced correctly. This is particularly important when using colour film. The correct exposure for **these more important sections** of the subject will then have to be arrived at by taking a **close-up reading**. This is done by approaching the more important parts of the subject and watching the exposure meter until you are certain that the effect exercised by the brighter parts of the subject has been ex-

cluded. You will recognize that this stage has been reached when there is no further appreciable change in the position of the exposure meter needle. Make a note of this reading, set it on the camera and **return to your original position** for the exposure.

When using **colour reversal film** such as Agfacolor Reversal Film CT 18 it is best to take readings of the **main high lights** in the subject.



Take close-up reading of important parts of subject. With colour reversal films point exposure meter at main brighter parts, with negative colour films at main darker parts.

Where subject contrast is low, which is often the case in fog, dull weather or shade, you will have to give a longer exposure. This is best done by using the next larger aperture or the next longer shutter speed. **This rule applies only to reversal colour films** and to the cases mentioned.

With negative colour films always point the exposure meter at the **main dark parts** of the subject.

FOR VERY POOR LIGHTING

Sometimes there is not enough light to give an exposure meter reading on any of the instantaneous shutter speeds. Then you use the "B" shutter setting for time exposures.



For time exposures: "B" setting, camera on a tripod, use cable release.

In such cases place the camera on a firm support, preferably on a tripod, attach a cable release (if possible with time lock) to the connection provided (see 5, main illustration, fig. A) and make the exposure.

The shutter stays open as long as pressure is exerted on the cable release button.

In many cases, particularly with indoor photography, a **flashgun** will be needed to supplement the available light and for this your Ambiflex is provided with a flash contact.

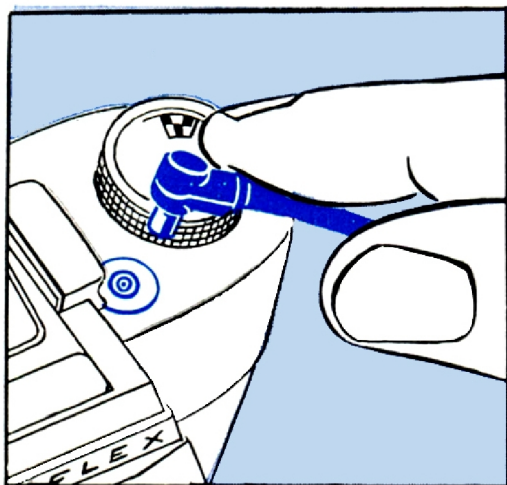

Flashguns permit indoor snapshots. Attach Agfalux or KM flashgun to a flash bracket, connect bracket to Agfaflex and join up flash lead.



Attach the flashgun (such as the Agfa KM or Agfalux) to a flash bracket and fix it to the Agfaflex by means of the screw. We advise you to use one of the usual types of flash brackets manufactured for this purpose. Finally you should connect the flash lead to the contact on the camera (see illustration). When looking at your Agfaflex from above you will see a small lever on the right which should be set to "X" or "M" according to the flash method used

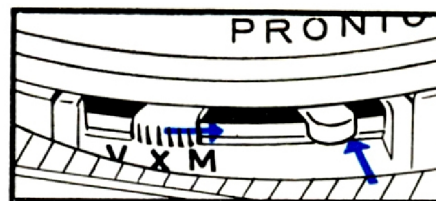

(see illustration). As the "M" synchronisation is rarely used this position is locked and can be released by pressing in the small key towards

the centre of the lens (see arrow on the right), thus enabling the lever to be set to "M".

However, the flash method better known and used most is the "X" synchronisation.

Please note therefore:

With "**X**" **synchronisation** = position of lever to X (or with delayed action to V) only use a shutter speed of $1/30$. The apertures to be used are given in the table on page 15.

With the **synchronising lever set to "M"** faster shutter speeds can be used. The apertures required are given in instructions enclosed with each package of flash bulbs.

When using an **electronic flashgun** the lever must always be set to **X**. Contrary

to flashbulbs **any** shutter speed can be used, although the apertures should not be taken from the opposite table. These are calculated from the **guide numbers** for the flashgun concerned, e.g. guide number 96 divided by a distance of 12 feet = aperture f/8. Electronic flashguns can be used for black and white or **daylight** colour films.

Flashbulbs: Shutter speed $1/30$ sec., lever set to "X".

Electronic flashgun: Any shutter speed, lever set to "X".

Special flashbulbs: Any shutter speed, lever set to "M" after pressing in locking key.



APERTURE TABLE FOR FLASHLIGHT

Distance from subject in feet	Clear bulb Colour negative film (CN 17) Black and white film 17° DIN = 40 ASA		Blue bulb Daylight colour reversal film (CT 18) 18° DIN = 50 ASA	
	Type of bulb		Type of bulb	
	XM 1 PF 1	XM 5 PF 5	XM 1 B PF 1/97	XM 5 B PF 5/97
5	f/11	f/16	f/11	f/16
7	f/8	f/11	f/8	f/11
12	f/5.6	f/8	f/5.6	f/8
17	f/4	f/5.6	f/4	f/5.6

Lever position at X, shutter speed always $\frac{1}{30}$ sec.

You can also use flash outdoors for brightening the foreground with photographs taken against the light, or when the light is so poor that instantaneous shutter speeds would not be sufficient.

THE REFLEX SYSTEM

The Ambiflex is a single lens reflex camera with interchangeable lenses. The image seen on the viewfinder screen is the same as that obtained through the camera lens.

This means that the picture on the negative is exactly the same as the one selected by you in the finder. This process is demonstrated in the sketch on page 16.

On the Ambiflex not only the lenses but also the viewfinders are interchangeable.

You therefore have the choice of viewing your subject either

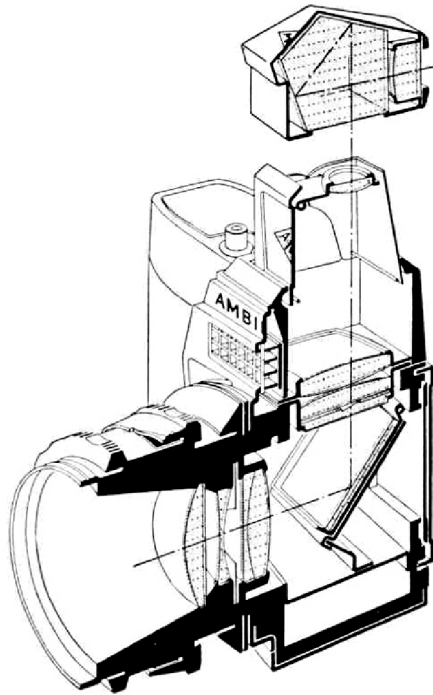

through the **hood waist-level finder** with the image the right way up but the wrong way round or through the **prism viewfinder** to give a true-vision image, according to taste or subject suitability.

CHANGING THE VIEWFINDER

No matter which viewfinder is supplied with your Ambiflex you always have the possibility to purchase the other one for interchanging as required.

Either type of viewfinder can be changed very quickly. All you have to do is to squeeze in both the side grips (upper illustration, page 17) and you can then lift out the hood viewfinder or prism finder, as the case may be. Both finders are replaced by pushing them down without squeezing the grips until they engage with an audible click. The Agfa Diamond should always point to the front, i. e. towards the camera lens.



Squeeze in both the side grips and lift out the finder. Replace finder horizontally and push it down until it engages.

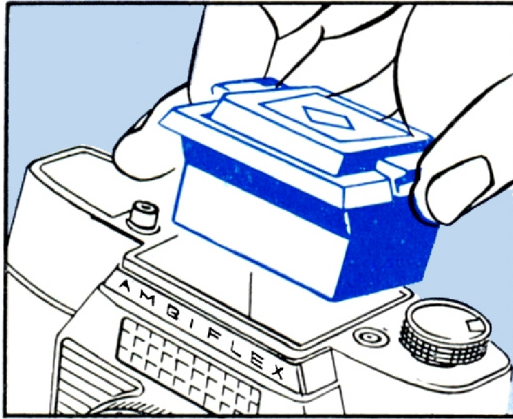

Open and close the waist-level hood viewfinder by the knob on the lid. If the image is not visible in the viewfinder operate the rapid transport lever.

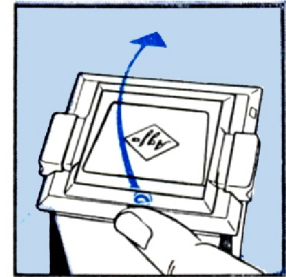

Open and close the hood **only** by the knob.

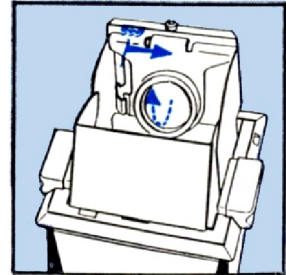

●
Raise the magnifier by sliding catch in direction of arrow.

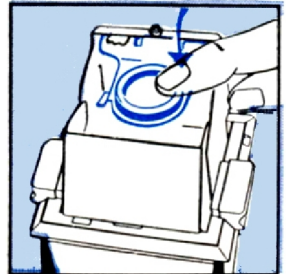

●
Before closing hood first lower magnifier.

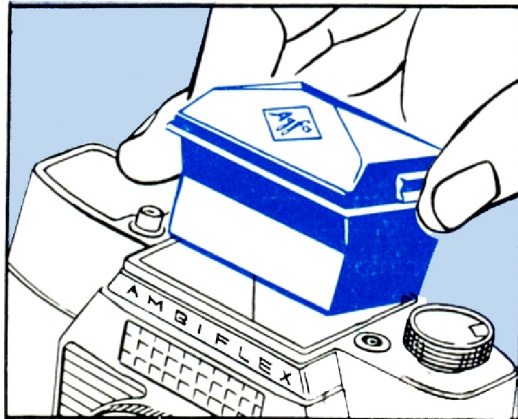

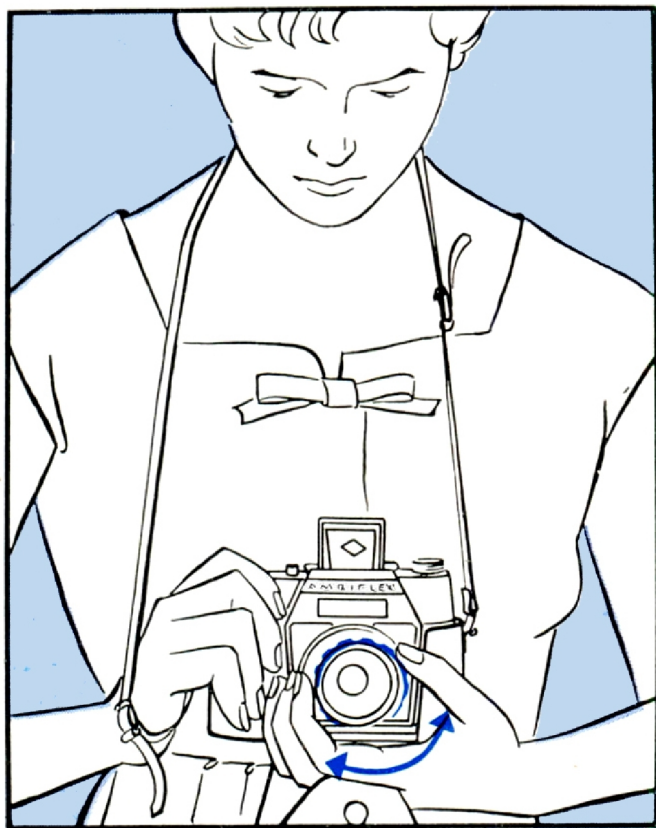

FOCUSING THE CAMERA WITH THE HOOD VIEWFINDER ATTACHED

To obtain sharp pictures hold the camera steady. We advise you to take your Agfaflex in both hands; the camera should rest on the palm of the left hand with the right hand holding the camera as shown in the illustration.

If you wish to view the subject with both eyes, you should hold the camera about 8 inches (20 cm.) below your face. When using only one eye first raise the focusing magnifier—by sliding the

● *When viewing subject with both eyes, hold camera 8 in. below face. When using one eye to view subject raise magnifier and hold camera close to the eye.*

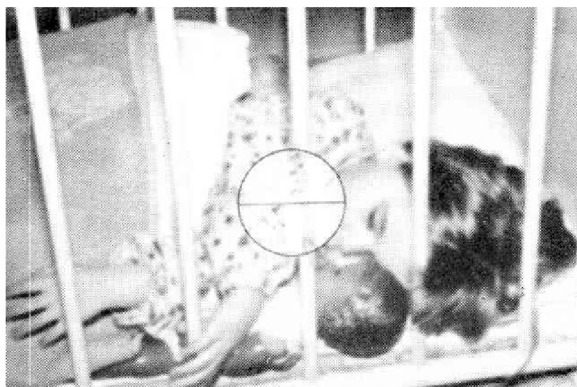

catch in the direction of the arrow—and then hold the camera close to the eye.

By turning the focusing ring with thumb and index finger of the left hand the camera can easily be focused.

A RELIABLE METHOD OF FOCUSING THE CAMERA

is provided by the split-image rangefinder. If you point the lens at a vertical line and turn the focusing ring you will find that the two halves of the picture in the small focusing circle do not coincide (upper illustration). As soon as these lines continue in single outline from top to bottom and a complete picture is obtained, the camera is correctly focused (lower illustration).

Turn focusing ring until vertical lines viewed in small focusing circle continue in one single outline (see illustration, page 19).



The Agfaflex with hood viewfinder attached can be held much steadier and safer if the strap of the ever-ready case with the sling around the neck—or the camera strap attached to the two studs on the camera—is used as additional support. The strap should be taut; this can be achieved by shortening the strap to make one or (when using the magnifier) even two wrist slings as illustrated.

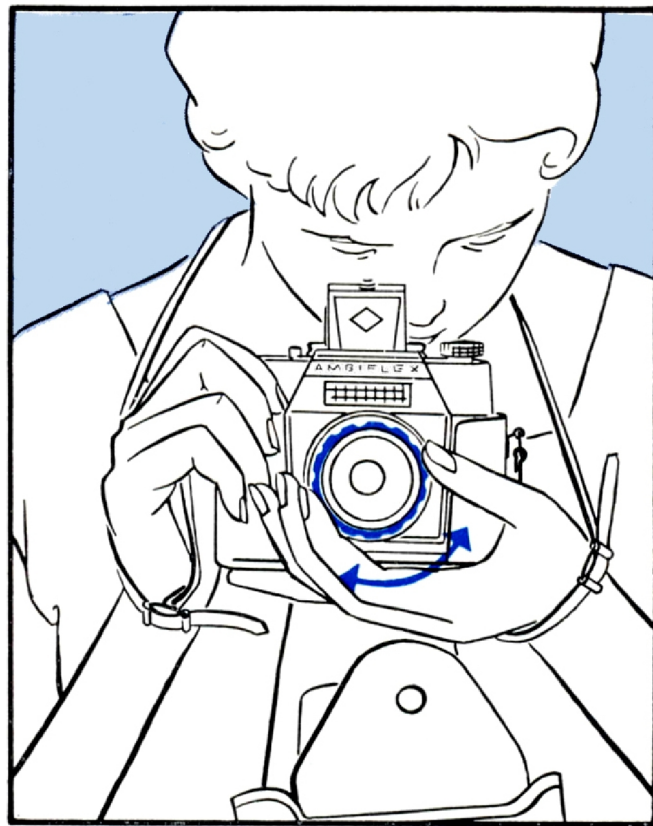

When using the waist-level hood viewfinder it is easy to take photographs pointing either upwards or downwards vertically from a standing position.

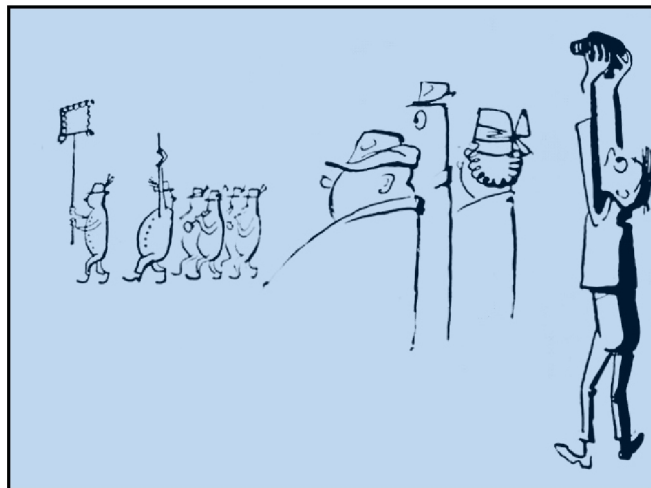
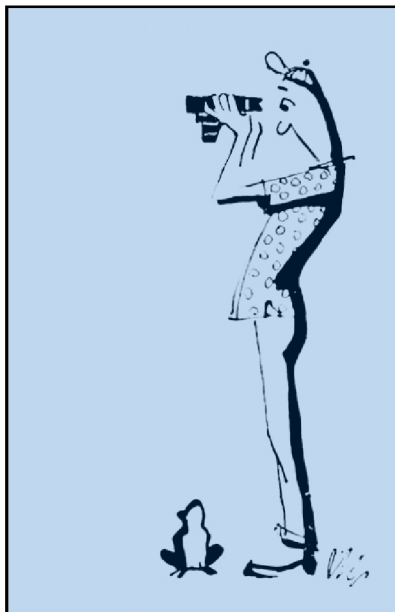

With the Ambiflex you can even photograph over a crowd if you hold the camera upside down above your head and view the ground glass screen from below.

By using the neck sling you can even photograph satisfactorily in a crouching position. ►

You can also photograph round the corner in order to capture natural and unaffected movements. ▼

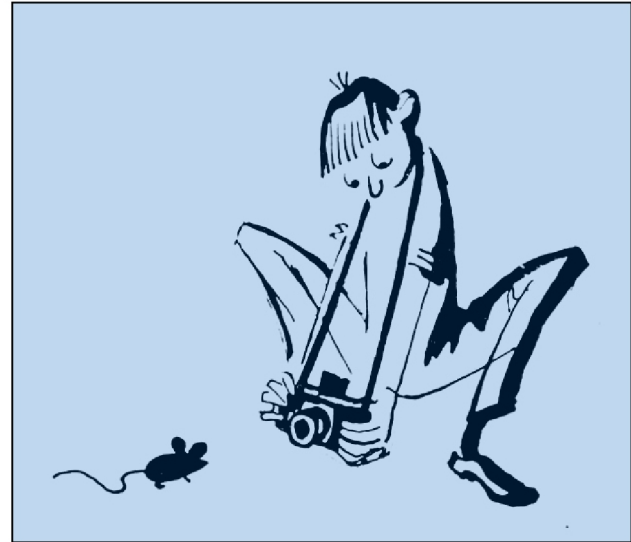
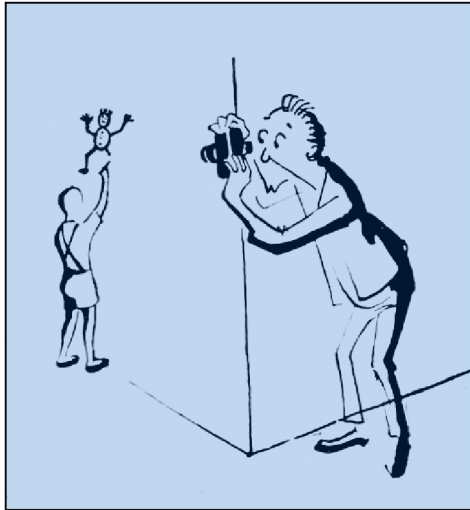

The hood viewfinder is suitable for practically all subjects.

FOCUSING THE CAMERA WITH THE PRISM VIEWFINDER ATTACHED

Although the hood viewfinder offers many advantages in viewing the subject (Agfaflex I) the Agfaflex II and III are more suitable when split-second timing is needed in capturing the subject, because its pentaprism gives you a true vision image the right way round. If the viewfinder image is not immediately visible first operate the rapid transport lever.

To obtain sharp pictures it is important to hold the camera steady in addition to focusing it exactly. You should therefore hold your Agfaflex in both hands with your thumbs along its back and both middle fingers on the focus-

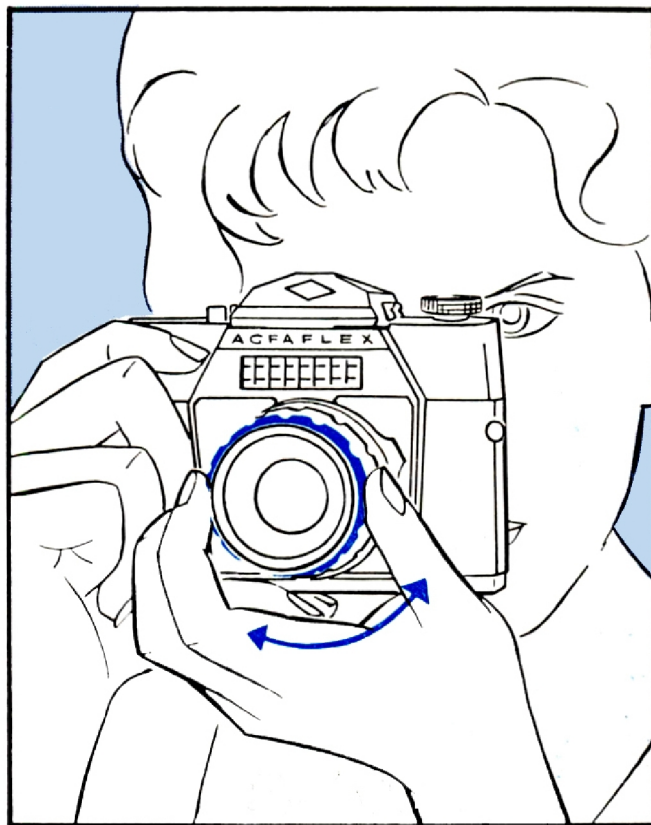

ing ring. You may also hold the camera with the right hand, supporting it on the palm of the left hand, and turn the focusing ring with thumb and index finger of the left hand, as shown in the illustration on page 23.

The Ambiflex is raised to the face and the eye-piece of the prism viewfinder brought as close to the eye as possible.

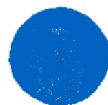

Hold your Ambiflex with both hands, raise it to the face and bring viewfinder eye-piece close to the eye, turn focusing ring with both middle fingers or with thumb and index finger of the left hand.

Turn the focusing ring until the image is sharp on the ground glass screen.

A **reliable check** is provided by the split-image rangefinder (see illustration, p. 19). Watch the vertical lines of the subject and turn the focusing ring. The two halves of the circle will start to converge. As soon as the broken vertical lines of the subject are no longer in double outline and a complete image is obtained, the camera is correctly focused.

No matter whether you use the **prism viewfinder** or **hood viewfinder** the image obtained through the camera lens corresponds exactly to that seen by you in the finder.

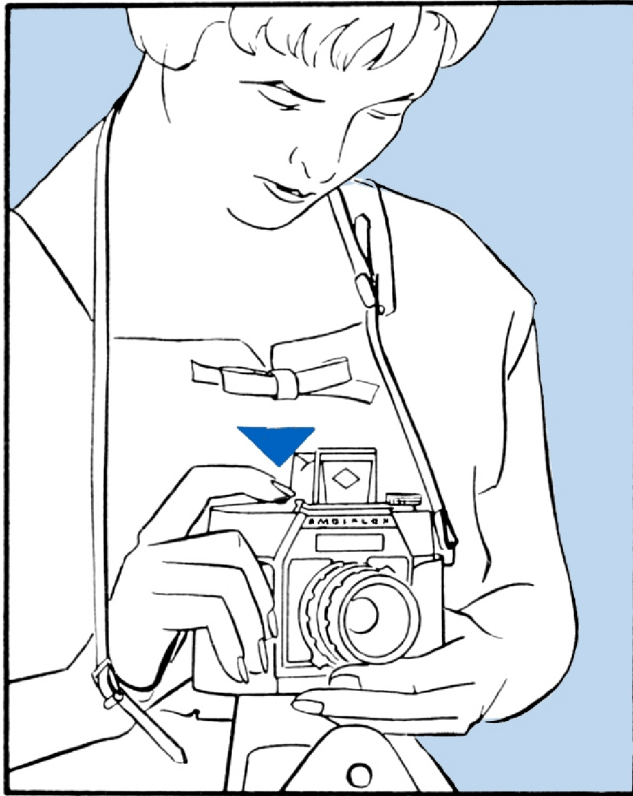

For photographs holding the camera in your hands you should use shutter speeds of $\frac{1}{60}$ to $\frac{1}{300}$ sec., but certainly not below $\frac{1}{30}$ sec. For longer exposure times a tripod should be used.

EXPOSING THE FILM

Photographs holding the camera in your hands should be restricted to shutter speeds of $\frac{1}{60}$ to $\frac{1}{300}$ sec., but certainly not below $\frac{1}{30}$ sec. If, however, you are working with the longer and heavier telephoto lens you should use shorter shutter speeds in order to

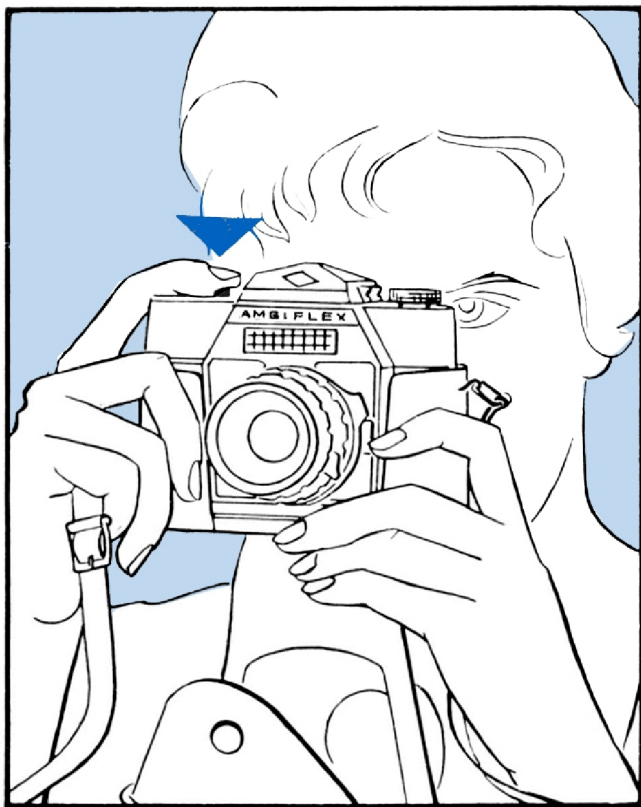

avoid blurring. Otherwise the camera should be placed on a rigid support or preferably screwed to a tripod.

A long cable release is indispensable and can be screwed into the threaded shutter release.

As soon as you have the subject lined up and focused, slowly press the shutter release right down with your index finger. After taking the photograph operate the rapid transport lever to prepare the camera for the next exposure.

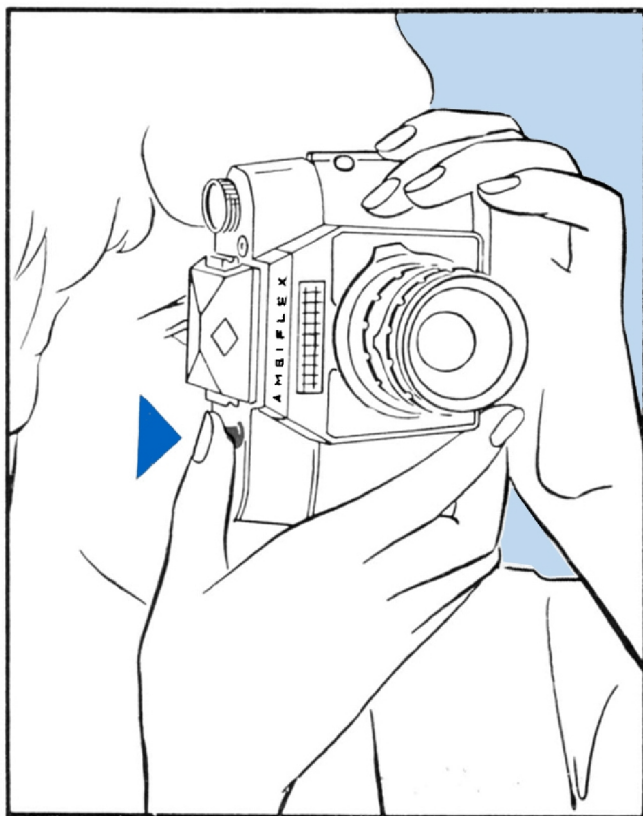

UPRIGHT PICTURES

are easier to take with the prism finder than with the hood viewfinder. Turn the camera through 90° to the right or left as desired and operate the shutter release either with your index finger or thumb, depending on the camera's position (see adjacent illustration).



To take upright pictures turn camera and release with thumb or index finger.

DELAYED ACTION

Occasionally you will want to be in the picture yourself. This is possible because your Ambiflex is equipped with a delayed action mechanism. A firm support for the camera is needed, or better still, a tripod.

After the exposure time has been set and the film has been wound on, set the small lever from "X" to "V". As soon as the shutter release has been depressed the delayed action mechanism is set in motion, actuating the previously set shutter speed after about 7 seconds, giving you plenty of time to get into the picture.

After making the exposure the lever automatically returns to its "X" setting and has to be moved to the "V" position again each time the delayed action is required.

All instantaneous shutter speeds can be used for delayed action (1-1/300 sec.) but not the "B" setting (time exposure). You can also use a flashgun in conjunction with the delayed action. Further details of this were given on pages 12-14.



Set lever to "V", operate shutter release which actuates previously set shutter speed after about 7 seconds.

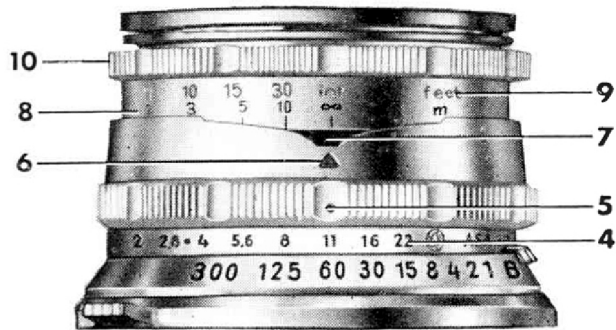

- 4 Aperture scale
- 5 Setting mark for shutter speeds and apertures
- 6 Focusing mark
- 7 Depth of field indicator (coupled with diaphragm ring) to show depth of field zone
- 8 Distance scale in meters
- 9 Distance scale in feet
- 10 Focusing ring

DEPTH OF FIELD

We already mentioned large and small lens apertures when talking about the function of the diaphragm. By turning the diaphragm ring it can be opened or closed. So that you can see yourself how the lens aperture of your camera opens and closes watch the lens from the front **after having operated the shutter release.**

When turning the diaphragm ring you will then notice that at large aperture a small number (e. g. f/2.8) and at small aperture a large number (e. g. f/22) is opposite the black dot.



Depth of field can be read off immediately against the distance scale, as indicated by the breadth of the visible part of the black vignette.



Large aperture
e. g. $f/2.8 =$

big opening
but small
depth of field.

Small aperture
e. g. $f/22 =$

little opening
but great
depth of field.



red triangular mark and indicate by its ends the depth of field zone on the adjacent focusing ring (see illustration, page 31). 

The depth of field is variable as you will see from this example; it increases as the aperture becomes smaller and the distance becomes greater.

To help you in finding out how far this zone of sharp focusing extends, your Ambiflex has what is known as a depth of field scale which is coupled with the diaphragm ring by means of an ingenious device. When you turn the diaphragm ring a black vignette will appear above the

SNAPSHOT SETTING

In moments of tension or humour, split-second timing is essential to capture your subject and it is therefore often advisable to use what is called a snapshot or zone focusing setting.

For this purpose the 3 metre (= 10 feet) and 10 metre (= 30 feet) markings are engraved in red on the focusing scale.

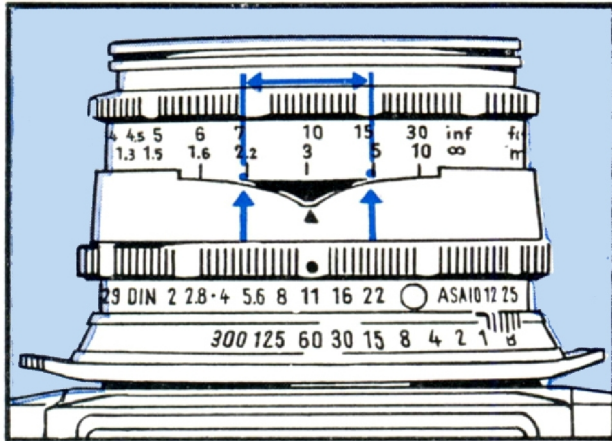

If you select an aperture and shutter speed combination in which $f/11$ is opposite the black dot and then set the focusing ring to 10 metres (= 30 feet), with the Color Solinar lens you will then obtain a depth of field from about 16 feet to infinity. If the camera is focused on 3 metres (= 10 feet) the sharp zone will be from about 7 to 18 feet.

In the adjacent illustration arrows and dots have been included to make this point clearer and show you how you can read off the depth of field as indicated by the black vignette.



Snapshot setting: Aperture at $f/11$.
Near shots: Red 3 (= 10 ft.)
= Depth of field from 7 to 18 feet.
Far shots: Red 10 (= 30 ft.)
= Depth of field from 16 feet to infinity.

THE RIGHT FILM FOR EVERY OCCASION

Before we explain how to load your Ambiflex with film, here are a few hints on different kinds of film.

*First of all there is **Agfa Isopan F**, 40 ASA (17° DIN). It is a sharp, fine-grain film of good exposure latitude.*

*In bad weather **Agfa Isopan ISS**, 100 ASA (21° DIN) is the right film. It allows you to use smaller apertures and shorter exposure times.*

*Where the light is really poor, use **Agfa Isopan Ultra**, 250 ASA (25° DIN). With subjects of normal contrast you can use one shutter speed faster than that indicated by the exposure meter.*

*If the worst comes to the worst and even Isopan Ultra is not fast enough, you can fall back on **Agfa Isopan Record**. This film is equal in grain and sharpness to Isopan Ultra but offers you the advantage of being able to stop down by a further aperture. Hints on its use are contained in the carton.*

*When you want extra fine grain for high degree enlargements **Agfa Isopan FF**, 16 ASA (13° DIN) is "your" film.*

Agfacolor films open up the world of colour to you. For more than twenty years these films have been great favourites due to the natural way they reproduce pastel tints and bright colours alike. Now their high speed has made colour snapshots a reality!

*For colour transparencies: **Agfacolor Reversal Film**.*

*For colour prints on paper: **Agfacolor Negative Film**.*

The correct way to load the camera with film is described on the next page.

HOW TO LOAD THE CAMERA

(to be carried out in subdued daylight, or when sun is shining, in the shadow of your body)

To open camera back, pull catch in direction of arrow.

Before loading each film the inside of the camera should be cleaned with a soft lens brush.

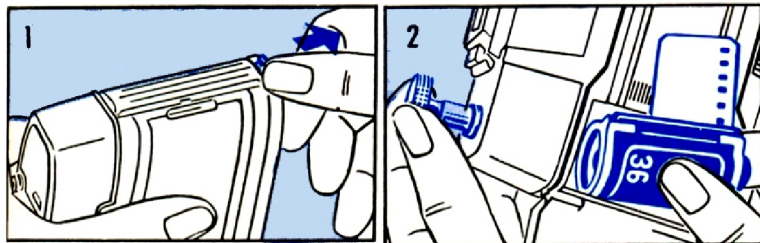

2 Draw out the rewinding knob with the left hand as far as it will go and insert the film cassette. Push back the rewinding knob.

5 Close the back of the camera by pressing until it snaps home.

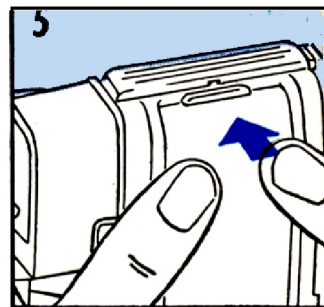

3 Draw out enough film for the narrow tongue to reach the take-up spool easily. Then turn the spool by its milled ring until the broad slit and small film perforation lug are uppermost.

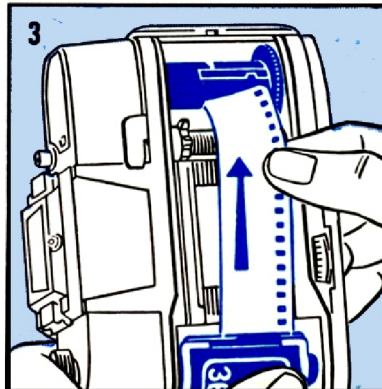

4 Insert the film in the slit so that the lug engages in the second film perforation. Now turn the winding spool in the direction shown by the arrow until about $\frac{1}{3}$ in. (1 cm.) full width of film projects from the cassette.

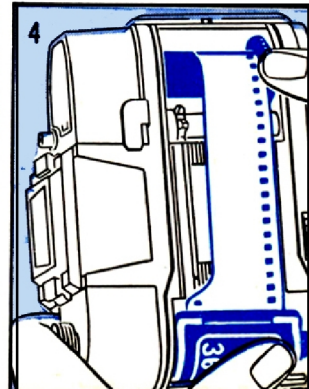

FILM TRANSPORT FOR THE FIRST EXPOSURE

Turn the film counter in the manner described on page 4 until the tip of the green triangle situated just in front of number 36 or 20 on the scale (depending on film length) is in line with the fixed mark on the camera back. Then operate the rapid transport lever as already described and press the shutter release. Repeat this process twice and your camera will be ready for the first exposure.

DOUBLE EXPOSURE PREVENTION

Your Ambiflex is designed so that you cannot expose the same negative twice. As long as you do not wind on the film the shutter release mechanism remains blocked. If you are not certain whether or not you turned on the film, a glance in the viewfinder will suffice; if you see nothing—in other words the reflex mirror is raised—the film needs winding on.

CAMERA NUMBER

Each lens of your Ambiflex bears a number and this also applies to the camera itself. This number is engraved next to the film counter on the back of your camera. It is a good thing to make a note of it directly after purchasing the camera.

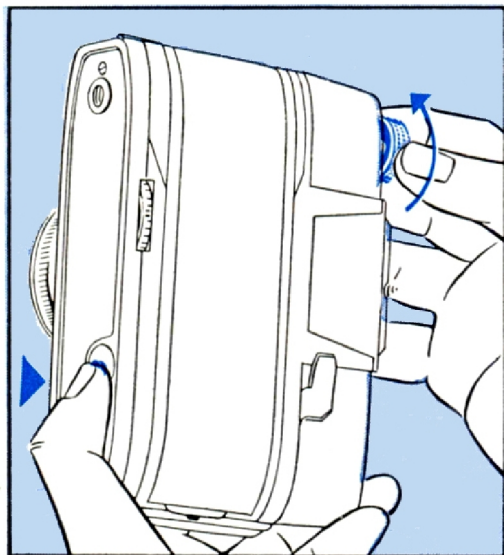

*Press in locking button,
pull out rewinding knob
to the first stop and turn
in direction of arrow.*



REWINDING THE FILM

AFTER EXPOSURE

After the last exposure (number 0 opposite the index mark) the rapid winding lever can no longer be operated. Since, however, the film in a miniature camera is wound openly on the take-up spool, it must be rewound into its light proof cassette before the camera back is opened. To do this, pull out the rewind button until you feel the first resistance (approximately $1/2$ ") and rotate in the direction of the arrow, at the same time depressing the locking button in the bottom of the camera (see illustration). When the rewind button can no longer be rotated further or when after releasing the locking button it can be rotated very easily the rewinding is complete, and the camera back can be opened as described on p.33. The rewind button is then pulled out as far as possible and the cassette removed. Put the cassette in its light tight packing and mark it "Exposed".

CHANGE OF EXPOSURE VALUES THROUGH THE USE OF FILTERS

When using colour filters for your **black and white pictures** the light passing through the lens is reduced according to the density of the filter and so the exposure time should be increased by what is known as the filter factor.

It is easier, however, to allow for the filter factor on the DIN/ASA scale of your camera in order to obtain the correct exposure reading with the filter attached. The adjacent table gives the necessary data for Agfa filters.

When removing the filter remember that the film speed should be re-set to its original DIN/ASA value.

Filters available for the Agfa Ambiflex:

For black and white pictures:

	Reduce the DIN setting by:	
<i>Agfa light yellow filter . . .</i>	<i>2</i>	} <i>degrees DIN*)</i>
<i>Agfa medium yellow filter . . .</i>	<i>3</i>	
<i>Agfa yellow-green filter . . .</i>	<i>4</i>	
<i>Agfa orange-red filter . . .</i>	<i>6</i>	
<i>Agfa UV (ultra-violet) filter . . .</i>	<i>no change</i>	
<i>For special Color Reversal Film exposures:</i>		
<i>Agfa Color Filter R 1.5 . . .</i>	<i>no change</i>	



**) For the correct ASA equivalent please refer to Film Speed Comparison Table on page 3*



Press in locking key, at the same time turning lens to the left.

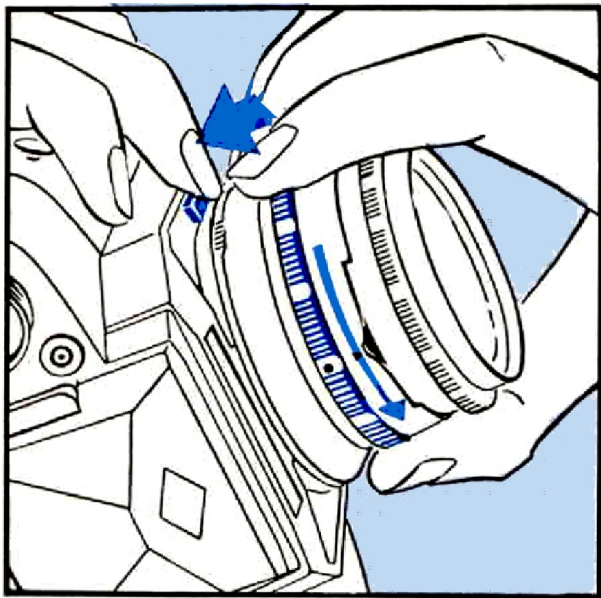

CHANGING THE LENS

A loaded camera should never be left exposed to light without its lens for any length of time; when changing the lens, therefore, do it as quickly as possible and always in the shadow of the body so that no direct light reaches the unprotected shutter or the reflex mirror in position for the next exposure. To remove the lens from its quick-change mount press in the locking key (10, see main illustration, Fig. A) at the same time giving the lens a turn to the left. When doing this, the lens should always be grasped by the fixed milled ring (as shown) and simply lifted out (see illustration, page 38), giving it a turn to the left (almost 90 degrees) **after** having pressed in the locking key.

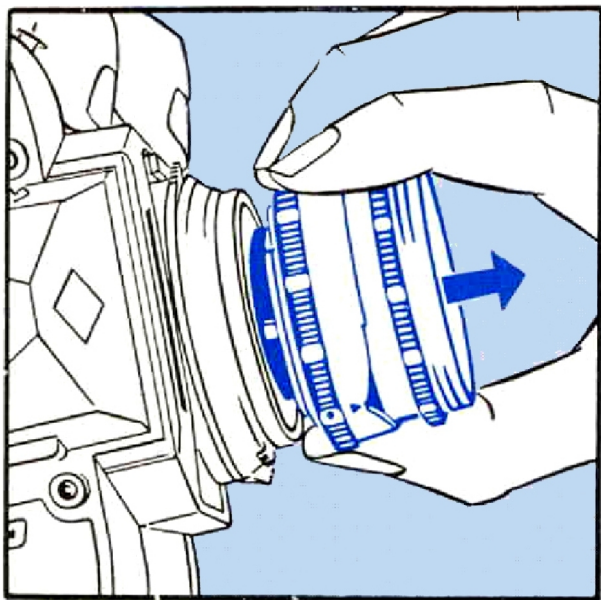

Insertion by dot location

On the inner mount of the camera a dot will be seen. Place the lens on the mount so that black dot for shutter speed and aperture settings and the dot on the camera body are opposite each other. After insertion the lens is locked by turning it clockwise and pressing it against the camera body (see illustration page **39**).

By looking at the lens from above you can always check its correct positioning. The black dot and the red triangular focusing mark must always be in the centre of the camera. In addition, a properly inserted lens cannot be turned any further to the left.



Remove lens firmly.

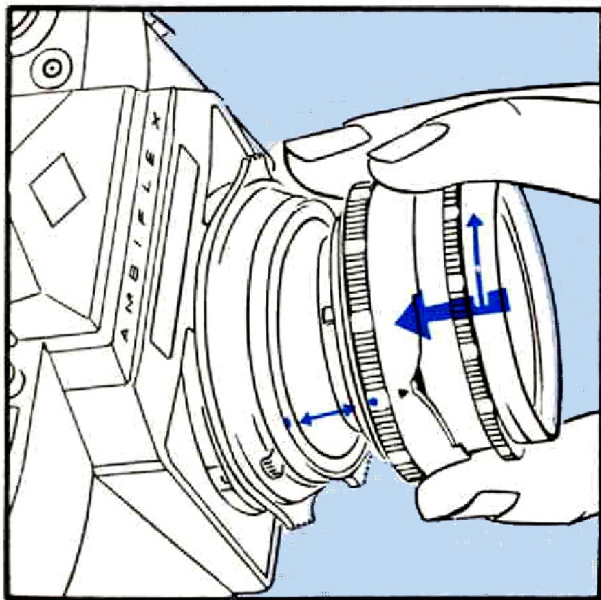

Set dots on mount and lens opposite each other, insert lens and lock it by turning clockwise.

Insertion without prior location

When taking pictures at night it will not be possible to use the dot location system but you may still wish to change the lens for your camera. In such cases you can feel the notch of the focusing mark and then grasp the lens in such a way that your thumb lies exactly over this notch. Then place the lens carefully against the camera body and when a click is heard press it against the camera at the same time giving it a clockwise turn so that it engages properly.

When inserting the lens the locking key (10, see main illustration, Fig. A) should **under no circumstances** be touched.



From **the same camera position** you can obtain the following effects with the interchangeable lenses:

35 mm. WIDE-ANGLE LENS

◀ (Agfa Color Ambion f/3.4 35 mm.)

90 mm. TELEPHOTO LENS

(Agfa Color Telinear f/3.4 90 mm.) ▶

50 mm. STANDARD LENS

◀ (Agfa Color Solinar f/2.8 50 mm.)

135 mm. TELEPHOTO LENS

(Agfa Color Telinear f/4 135 mm.) ▶



SOME GENERAL HINTS FOR YOUR PHOTOGRAPHS

A very striking effect can be obtained if you photograph the subject **by oblique sunlight**. Of course you can also photograph with the sun behind you, but then you must be careful to keep your own shadow out of the picture.

Photos **against the light** call for some experience because the rays of the sun should not fall directly on the lens. It is best to take advantage of the shadow of a tree or house and use a lens hood too. Photographs without sunshine are also possible. With an overcast sky, contrast can be heightened by using a medium yellow or orange-red filter (make allowance for the filter factor—see page 36).

Try out shots from a mountain peak or

tower, including foreground interest of some kind. Remember the foreground in your landscape photos too, and enliven them by including a person, way, fence or other suitable object. A change in the camera position is also interesting. Try out "bird's-eye" or "worm's-eye" views at an oblique angle.

Clouds, particularly the cumulus type, are very effective. By using a yellow filter with black and white film they can be brought out very well and with an orange-red filter you can even produce storm cloud effects.

Filters may only be used with black and white film.

Before each exposure examine the subject several times through the viewfinder to see whether the oblong or upright picture is better.

Action photographs of processions and similar subjects are easier to take if you work out the most suitable distance, set the focusing ring to this figure and let the procession enter this sharp zone. This leaves you free to concentrate on the picture in the viewfinder and to press the shutter release at the moment when the light circular portion of the rangefinder gives a sharp image.

DEPTH OF FIELD TABLE FOR THE AGFA COLOR SOLINAR f/2.8 50 mm. LENS

Diameter of circle of confusion: 0.03 mm.

Focused to	With diaphragm set at						
	f/2.8	f/4	f/5.6	f/8	f/11	f/16	f/22
	sharp definition from . . . ft. to . . . ft.						
3	2' 11"–3' 1"	2' 10"–3' 1"	2' 10"–3' 2"	2' 9"–3' 3"	2' 9"–3' 4"	2' 7"–3' 6"	2' 6"–3' 9"
3½	3' 5"–3' 7"	3' 4"–3' 8"	3' 3"–3' 9"	3' 3"–3' 10"	3' 1"–3' 11"	2' 12"–4' 3"	2' 10"–4' 7"
4	3' 10"–4' 2"	3' 10"–4' 2"	3' 9"–4' 4"	3' 7"–4' 5"	3' 6"–4' 10"	3' 4"–5'	3' 2"–5' 7"
4½	4' 4"–4' 8"	4' 3"–4' 9"	4' 2"–4' 11"	4' ½"–5' 1"	3' 11"–5' 7"	3' 8"–5' 10"	3' 5"–6' 8"
5	4' 9"–5' 3"	4' 8"–5' 4"	4' 7"–5' 6"	4' 5"–5' 9"	4' 3"–6' 5"	3' 12"–6' 9"	3' 8"–7' 10"
6	5' 8"–6' 4"	5' 7"–6' 6"	5' 5"–6' 9"	5' 2"–7' 2"	4' 11"–8' 1"	4' 7"–8' 10"	4' 2"–10' 9"
7	6' 7"–7' 6"	6' 5"–7' 9"	6' 2"–8' 1"	5' 11"–8' 8"	5' 7"–9' 6"	5' 1"–11' 4"	4' 7"–14' 9"
10	9' 1"–11' 1"	8' 9"–11' 7"	8' 5"–12' 4"	7' 10"–13' 9"	7' 6"–17' 2"	6' 6"–22' 4"	5' 9"–42'
15	13' 1"–17' 7"	12' 5"–19'	11' 7"–21' 3"	10' 7"–25'	9' 6"–39'	8' 2"–96'	7'–∞
30	23' 1"–43'	21'–53'	18' 9"–75'	16' 2"–215'	13' 10"–∞	11' 1"–∞	9'–∞
∞	99'–∞	54'–∞	41'–∞	30' 4"–∞	22' 11"–∞	16' 4"–∞	12' 1"–∞

The distances to the subject are measured from the film plane (rear edge of camera body).

An ever-ready case is well worth having because it protects your Agfa Ambiflex from knocks and the weather, apart from making it easier to carry. ►

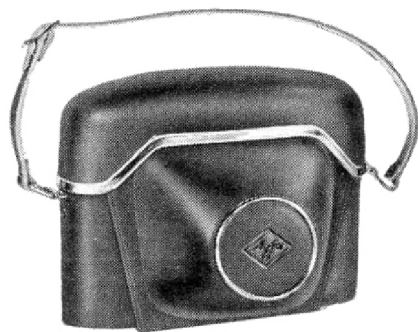

Agfa filters are supplied in standard mounts for your Agfa Ambiflex. Each screw mount has a double thread so that combinations of filter and close-up attachment or filter and lens hood are possible. ►

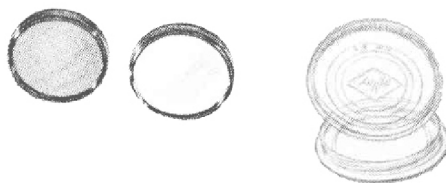

The Agfalux pocket flashgun is small, light and handy. A practical zip case is supplied as well. ►

Developing your own films increases the pleasures of photography. With the Agfa Rondix 35 or Agfa Rondinax 35 U you can actually develop them in daylight. ►

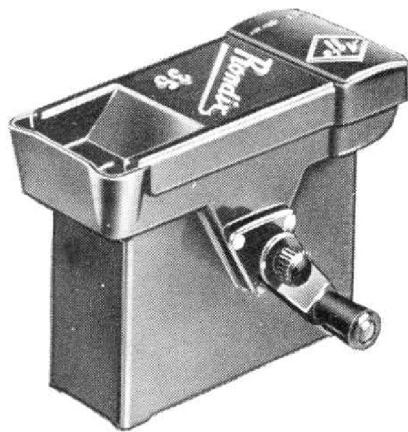

It is also an easy matter to explore the wonders of the miniature world with your Ambiflex. All you need is the Agfa close-up attachment No.1 covering a range of 22 to 35 inches (55 to 90 cm.) or No. 2 covering a range of 15 to 22 inches (38 to 55 cm.). By combining both you can photograph objects at a distance of 9½ inches (24 cm.).

The versatility of your Ambiflex increases with the use of interchangeable lenses of various focal lengths. Ask your dealer to attach the supplementary lenses to your Ambiflex to give you an idea of their effect.

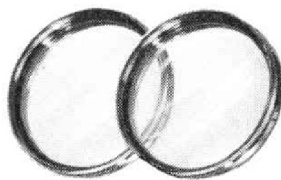

The finishing touch to your brilliant colour transparencies is provided by an Agfa projector, such as the high quality Agfa CP 35, with which you can re-live all the wonderful photos taken with your Ambiflex.

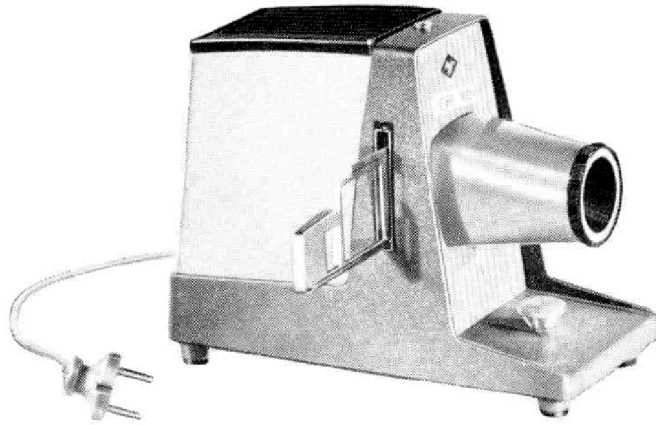

To meet more exacting wishes there is the new Agfa Diamator S with fully automatic remote control operated from the comfort of your armchair. It takes care of all the manual operations at the press of a button.

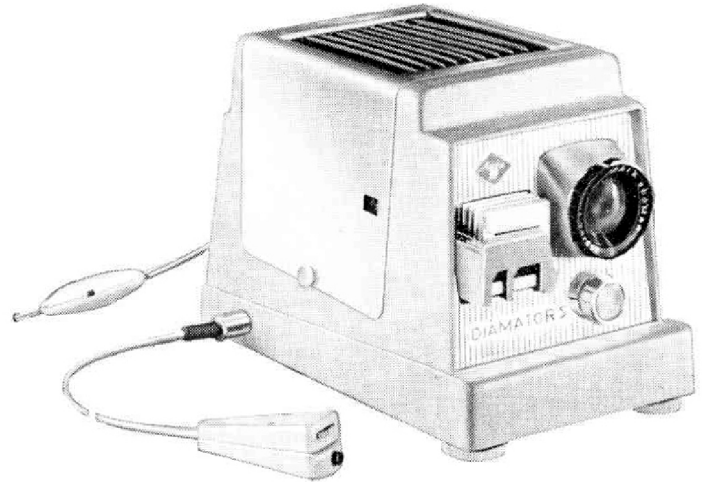

ALPHABETICAL LIST OF CONTENTS

	Page		Page
Accessories	46-48	Film hints	32
Changing lenses	37-39	Film speed	3
Changing the viewfinder	16-17	Film transport	5
Choosing a lens	40	Film type indicator	2
Comparative film speeds	3	Filters	36
Delayed action	28	Flash synchronisation	13-15
Depth of field	29-31	Holding and focusing the camera	
Depth of field table		with hood viewfinder	18-22
Color-Solinar f/2.8 50 mm.	43	with prism viewfinder	23-24
Color-Solagon f/2 55 mm.	44-45	Loading the camera	33
Diaphragm	7	Opening the hood viewfinder	17
Double exposure prevention	34	Photographic hints	41-42
Exposure calculation	11-12	Reflex system	15-16
Exposure readings	8-10	Rewinding and removing the film	35
Exposing the film	25-27	Shutter	6
Film counter	4	Time exposures	12

We reserve the right to make structural alterations to the Agfa Ambiflex arising from further development of the camera.

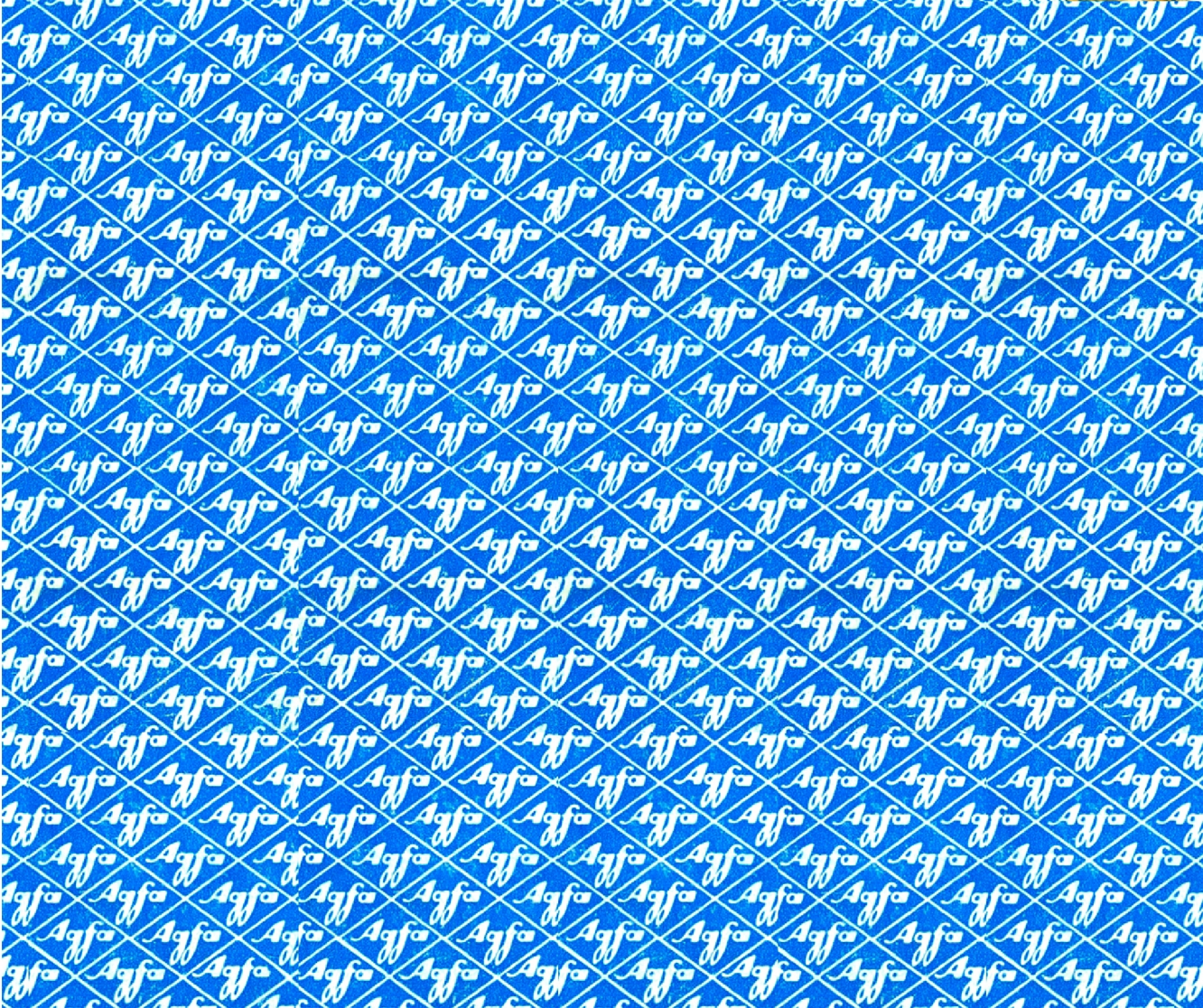

AGFA AKTIENGESELLSCHAFT
CAMERA-WERK MÜNCHEN

MADE IN GERMANY