

dbx

Model 4BX

**Three-Band
Dynamic-Range Expander
with
Impact Restoration
and
Remote Logicontrol**

Owner's Manual

INSPECTION and INSTALLATION

Your unit was carefully packed at the factory in a carton designed to protect it. Nevertheless, we recommend examining both carton and contents for any signs of damage that may have occurred during shipping. If there is evidence of damage, don't destroy the carton or any of the packing material, and notify your dbx dealer immediately.

In any case it is a good idea to save the carton and packing materials should you ever need to ship your unit in the future.

In addition to a model 4BX and this instruction manual, the carton should contain:

- 1) a set (two pairs) of hookup cables with RCA phono, or pin, plugs;
- 2) a warranty/registration card;
- 3) a pair of brackets for mounting the unit into a standard 19-inch(483-mm)-wide equipment rack (see below).

No special ventilation is required in any installation; other components may be stacked above or below the 4BX provided that they themselves do not get hot.

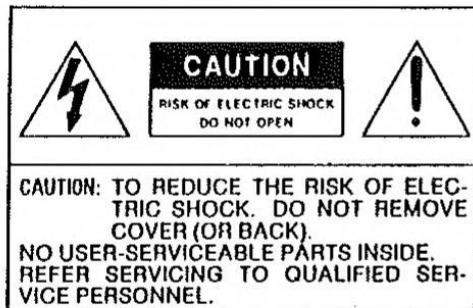

This symbol is intended to alert you of the presence of uninsulated dangerous voltage within the unit's enclosure that may be of sufficient magnitude to constitute a risk of electric shock to persons.



This symbol is intended to alert you of the presence of important operating and maintenance instructions in the literature accompanying the unit.

WARNING: To Prevent Fire or Shock Hazard, Do Not Expose This Appliance to Rain or Moisture.

"dbx" is a registered trademark of dbx Inc.

CONTENTS

Operating instructions:	
Front panel and remote control.....	2
Connections:	
Rear jacks and controls.....	6
About impact restoration, expansion, and dynamic range.....	8
Typical hookups.....	11
Usage notes and cautions.....	13
Specifications and notes.....	15
Warranty and factory-service information	
Important information for users in the UK.....	16

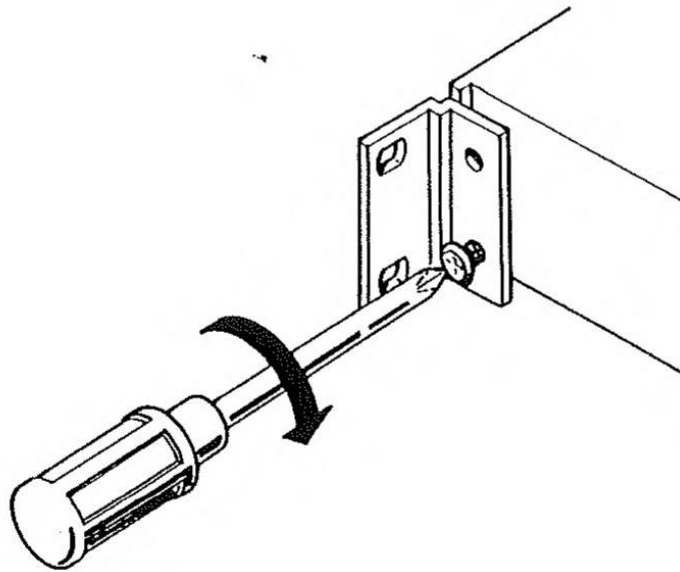

OPERATING INSTRUCTIONS: FRONT PANEL and REMOTE CONTROL

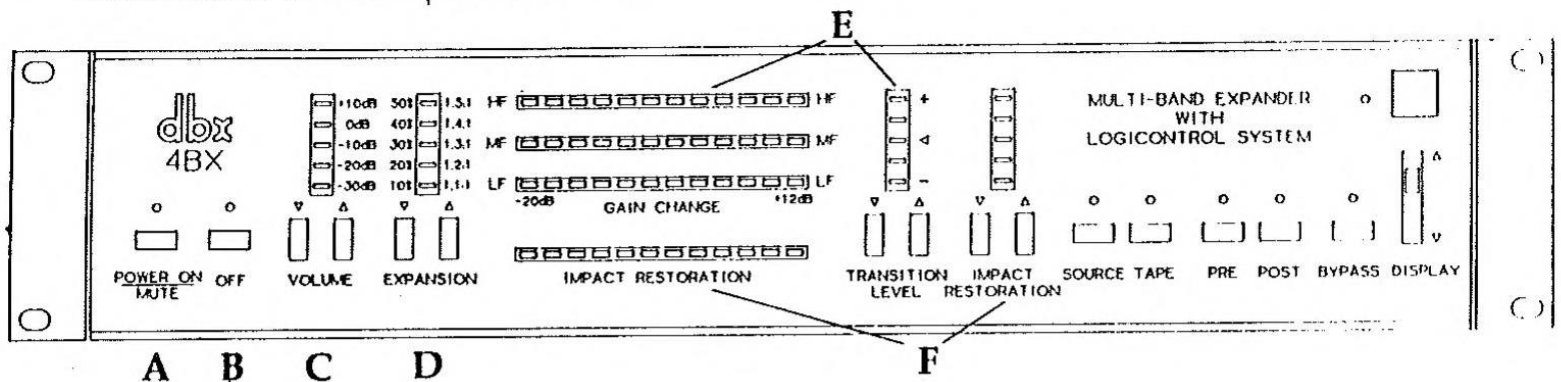

A POWER ON/MUTE. Push this button to turn the 4BX on. It always comes on muted; push the button a second time to unmute the sound. (The very first time you do this the sound comes on at -15 dB; subsequent turn-ons and unmutings make the sound come on at the level it was at before the unit was last turned off, so be careful. If you're in doubt about how loud it was the last time, press VOLUME down a couple of seconds before unmuting or, better yet, press VOLUME up and don't unmute at all.)

To mute the sound again, as for answering the phone, press the button a third time. The muting is not total: the sound is lowered by some 40 dB from the 0-dB indication, however loud that is. (See the "Volume" discussion, below, for advice on setting 4BX and preamplifier* levels.)

The LED (light-emitting diode) above this button goes on whenever the sound is at this -40 -dB level, whether muted or just turned down; it doesn't indicate "power on."

B OFF. Push this button to turn the 4BX off. The LED above it, which lights up whenever the power is on, will go out.

Note: When you turn the 4BX off, it is only removed from the signal path; it does *not* shut down the sound. If you've been listening at a -20 - to -30 -dB level (again, see the "Volume" section) and press OFF, the sound suddenly will increase by a lot. This is most likely to happen when using the remote control. So the point is that the 4BX's remote is significantly different from a conventional TV "armchair" control, whose Off button shuts things off entirely. The 4BX's OFF bypasses the unit, reinstating the sound at the preamp's level (that is, at unity gain). MUTE is what you press to lower the

volume. Push OFF after the rest of your system is shut down, perhaps, or at least press it cautiously, not casually.

C VOLUME. These buttons raise and lower the volume, or gain, of the sound, according to their arrows and in the amount shown by the LED column above them. The 0-dB setting in this column is the unity-gain position, where the level of loudness is the same as from your preamp, the 4BX making no increase or decrease. The volume range is 50 dB, the last 10 coming between the -30 -dB LED fully lit

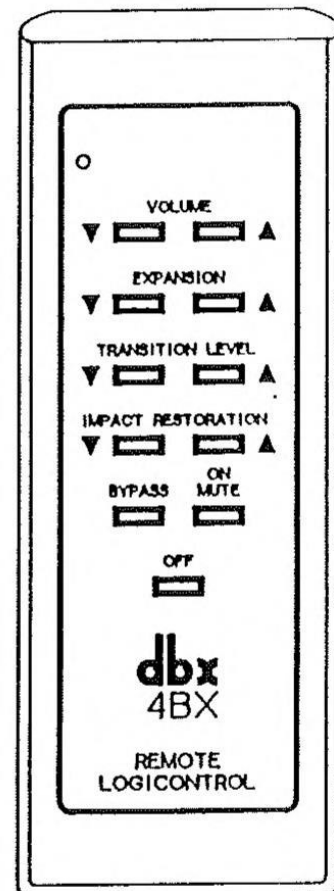

*For the sake of simplicity, "preamp" will mean a preamp, receiver, or integrated amplifier.

and fully dark. The VOLUME down button does not turn the sound off; it just lowers it to the muted (-40 dB) level.

In establishing levels with your 4BX, it is best to begin by setting the volume to its maximum, +10 dB. Then turn up the preamp's volume control to as high a level as you would normally listen to comfortably. In this relationship the 4BX always will be lowering the volume from this high level, and the probability of alarming level jumps when the 4BX is put into or taken out of the signal path is reduced. (See the discussion of the OFF button.) Still, it's possible, if the levels are set as suggested here and you're listening at below -30 dB and press OFF, for the sound to jump 35-40 dB, a startling but probably not damaging occurrence. Again, caution is warranted with the OFF button.

You'll be interested to know that each 10-dB increase in level calls for 10 times as much power, even though the difference to the ear is only what most people call twice as loud. In fact, each 3-dB increase (which you'll have to approximate through the partial illumination of the next VOLUME LED), even though it sounds small, requires twice as much power.

- D EXPANSION.** These buttons control, according to their arrows, the amount the 4BX expands the dynamic range of the sound. A setting of 1.2 results in a 20-percent increase in dynamics, 1.4 a 40-percent increase, and so on. In the latter case, an input signal with 40 dB of dynamic range will be expanded to 56 dB and a signal with 50 dB will go to 70 dB. The maximum expansion, as marked, is 50 percent.
- E GAIN CHANGE and TRANSITION LEVEL.** The GAIN CHANGE LED rows show the amount of gain (volume) change in each of the three frequency bands the 4BX divides the audio program into. HF stands for high frequencies, above approximately 6 kHz; MF is the mid-frequencies, between about 150 Hz and 6 kHz; and LF is the low frequencies, below approximately 150 Hz. The red LEDs in each, to the right, show upward expansion (volume increase) to +12 dB, and the yellow LEDs, to the left, show downward expansion (volume decrease) to -20 dB. (The amount of HF expansion can be separately adjusted to suit various kinds of music and different

speakers, and to vary the overall expansion "mix"; see *Connections: Rear Jacks and Controls*.)

The point between upward and downward, the center or unity-gain point, is set by the TRANSITION LEVEL buttons, according to their arrows, and is shown in the LED column above them. When the incoming program signal is above (louder than) this set level, the 4BX expands it upward, making it louder still. When the signal is below (softer than) this level, the 4BX expands it downward, making it still softer. And when the signal is exactly at the level set by these buttons, it goes through unexpanded.

Set the TRANSITION LEVEL so that the red LEDs in the three GAIN CHANGE rows glow during the louder parts of the music and the yellow LEDs glow during the quieter parts. Please note that this setting needn't be exact; the buttons are there for your convenience in setting and matching levels among sources.

In controlling the ratio of the sound that gets expanded upward to that which gets expanded downward, the TRANSITION LEVEL also functions, whenever the EXPANSION level is above 1.0:1, as a sort of sub-volume control (after the VOLUME buttons). We mention this because if you have the TRANSITION LEVEL set on the low side and press BYPASS (which, as will be discussed presently, removes only the expanding action of the 4BX from the signal path, not the VOLUME action), the sound can jump up as much as 20 dB. Likewise vice versa: if the TRANSITION LEVEL is set high and the 4BX is taken out of BYPASS and put back into operation, the sound will increase suddenly. This may well be startling but, as was the case with hitting the OFF button, it is unlikely to do damage.

- F IMPACT RESTORATION.** These buttons, of course, increase and decrease the amount of impact restoration the 4BX provides, as shown by the LED column and the LED row. "Impact restoration" describes a dbx expansion circuit that works on (increases the volume of) the initial attack of a musical transient, e.g., a drummer's rim shot. All the LEDs in the row are red (there is no downward expansion of transients) and are read from left to right, up to +12 dB. This upward expansion of attacks adds considerable crispness and, well, impact to the sound, and does so musically. Live music has this exciting

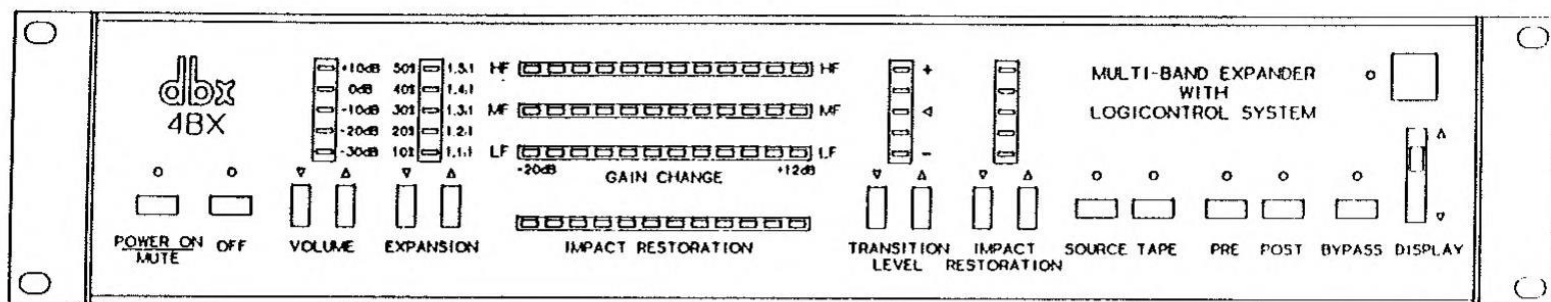

G H I J

quality, and we think that the 4BX is quite successful at making compressed, limited, and clipped recorded music approximate live (see *About Impact Restoration*). You will quickly find the best-sounding settings for various kinds of music, classical, jazz, and/or popular.

- G **SOURCE and TAPE.** These buttons choose what program you listen to. Push SOURCE for your record player, radio (tuner), or Auxiliary inputs (e.g., your TV/VCR). Now you can expand these sources, if you wish. Push TAPE to listen to your deck play a tape and/or to "access" (bring into the signal path) any signal processors connected in the 4BX's tape loop (see *Rear Connections*). To expand a tape being played, the POST button, discussed next, must be pressed; to expand one of the other programs (SOURCE), either PRE or POST may be pressed.

If your tape deck has monitoring capability (three heads), you can alternately push SOURCE and TAPE to check on a tape being recorded.

- H **PRE and POST.** These buttons control where the 4BX's actions take place with respect to taping.

The more common application will be expanding a tape on playback, with both TAPE and POST pushed in. This places the 4BX after the deck's output (of course the deck is in play, not record). If you have not a tape deck but a signal processor in the 4BX's tape loop, pressing POST and TAPE places the 4BX expansion etc. after the signal processor, which most often is where you'd want it to be.

If, however, you push PRE and TAPE, the 4BX comes *before* your deck, making it possible to expand and "punch up" the signal before it gets recorded onto the tape. But be advised that this calls for considerable care, for a number of reasons.

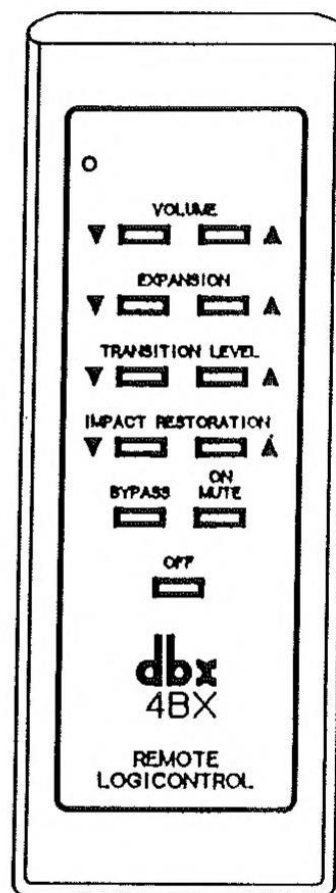

K

First, in almost all cases, extreme expansion, and impact restoration especially, will make the program dynamics wider and "hotter" than any cassette deck has the capability of handling. (All cassette decks are readily overloaded by powerful signals; open-reel recorders have an easier time of it.) Conservative recording levels and moderate expansion and impact-restoration settings will help, although conventional mechanical recording-level meters (needles) cannot respond fast enough to something as quick as impact restoration. It is best if dbx noise reduction is employed, since it gives you more room than the other noise-reduction systems, and if the

tape deck has electronic (lighted-bar) meters set to their peak-reading position, in order to give you an accurate idea of how potent the 4BX's effects are.

Second, if PRE is used, the 4BX's other controls also come before the recording—that is, VOLUME, POWER ON and OFF, MUTE, and BYPASS. Therefore they must not be pushed thoughtlessly during the recording. This means, among other things, that the loudness level in the room either has to be as you like it for the duration of the selection or has to be controlled by your preamp only. Of course it is possible to adjust the 4BX's LOUDNESS and the tape deck's recording controls beforehand so their levels are appropriate for both listening and taping. And in many instances it might be a great convenience to have an instant remote capability for lowering or muting applause, commercials, etc. after the selection being recorded is over. It's just that you will want not to press any 4BX buttons casually when you're recording in PRE.

For foolproof results, then, we recommend that you do your expansion and impact restoration on playback. But if you do choose levels and settings wisely and monitor carefully, you'll be able to reduce noise in the original program, add impact, expand dynamics, and preserve all these changes on the tape.

Note that when you've pressed SOURCE (say, to compare the tape recording with the original), PRE and POST still affect the taping even though they don't affect SOURCE. Thus if you're making a tape and using SOURCE and TAPE to check it (to monitor it), be sure not to press PRE and POST back and forth. Probably it is best to monitor a tape being made of a PRE-expanded program using the deck's own Tape/Source switch.

- I **BYPASS.** Pressing this button removes the 4BX's expansion and impact restoration from the signal path—but that's all. Everything else still works. Which means (among other things) that you can still control your stereo system's loudness remotely, even with no expansion or impact restoration at work.
- J **DISPLAY.** This controls the brightness of the 4BX's LEDs (except for the one which indicates power, above OFF), from full intensity to very dim.

- K **REMOTE LOGICONTROL.** As we have been saying all along, the handheld remote lets you control all of the 4BX's functions except SOURCE/TAPE and PRE/POST. And by extension, naturally, it is a remote volume control for your entire stereo. At last, you can lower or mute the sound in the room without having to get up and go over to your system.

The control is not particularly directional, and can operate over a long range (25 feet or so). Since it transmits infrared light, furthermore, its signal can be bounced off walls and windows, as necessary. However, its action is certain only when it's aimed at the 4BX's receiving window, above the DISPLAY slider. (The adjacent LED indicates reception.) There are times when too great an off-axis direction of aim or too much distance from the 4BX can result in the loss of remote capability. Similarly, too much light shining on the front of the 4BX may create an optical interference or "background noise" that the Logicontrol must be stronger than in order to get through; if the room lights are too bright, it will fail.

Generally, the Logicontrol will enable you to do what you want with the 4BX at any reasonable distance.

The supplied 9-V alkaline battery should last a year or more in typical use; replace it with the same type, i.e., alkaline.

CONNECTIONS: REAR JACKS and CONTROLS

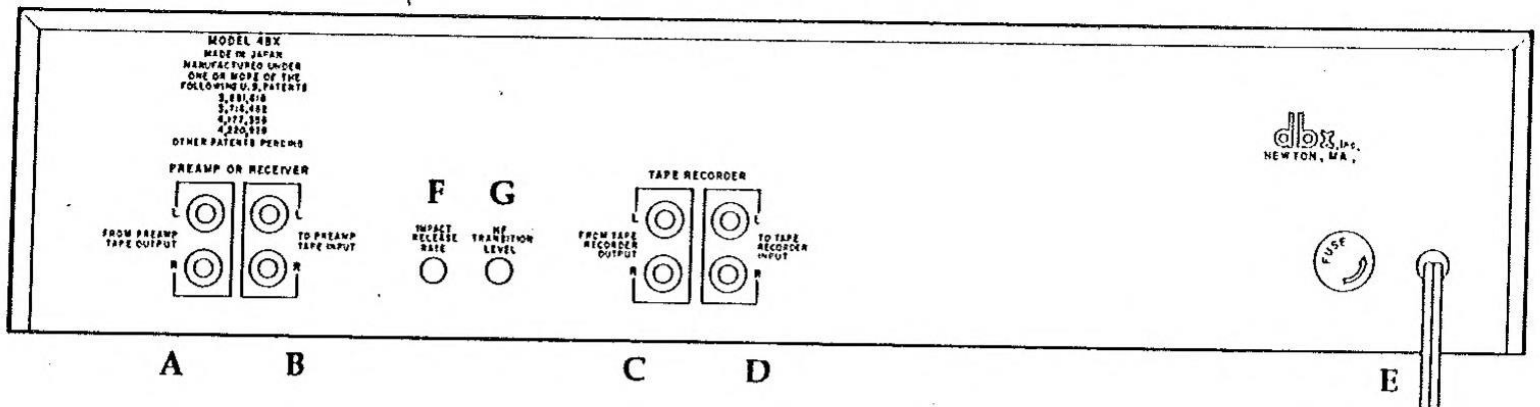

- A FROM PREAMP TAPE OUTPUT.** Connect one of the sets of "Tape Out" jacks on your preamp to these 4BX inputs, left to left and right to right. (Right commonly is designated by red cable ends; for some people it helps simply to remember that "red" and "right" start with the same letter.) You can use either Tape 1 or Tape 2.
- B TO PREAMP TAPE INPUT.** Connect these outputs to your preamp's "Tape In."** Be sure that this signal return goes to the same-number tape-monitor loop on your preamp as it came from, i.e., no. 1 or 2 or whatever. Also note that in order for you to use your 4BX in this hookup, your preamp must always be switched on its front panel to the corresponding Tape position (Tape 1 or Tape 2, etc.).
- C FROM TAPE RECORDER OUTPUT.** Connect your deck's PLAY, OUTPUT, TAPE OUT, LINE, or MONITOR outputs to these 4BX inputs.
- D TO TAPE RECORDER INPUT.** Connect these outputs to the INPUT, LINE IN, REC(ORD) or whatever on your tape deck.
- Note: regarding these two tape-deck hookups, if you have a dbx noise-reduction unit or other signal-processing equipment, see the connection diagram on page 12.
- E FUSE HOLDER and POWER CORD.** Replace a blown fuse with the same type (as marked), but if the new fuse blows, have the unit checked. Connect the power cable to the appropriate power source; the correct information is printed on the 4BX's rear panel next to the cable's entry hole. The 4BX may be damaged if it's not connected to the proper power

source (US/Canada, 117 V ac, 50-60 Hz; elsewhere, also as marked). If your unit has a switch for different power sources, be sure it's set correctly.

A word about switched and unswitched ac outlets on other components to plug the 4BX into. If the 4BX is in an unswitched outlet, its memory still operates when it's off, and when you turn the unit on, all functions are in their last mode, as noted earlier. However, on "first power" (which is every time if the 4BX is in a switched outlet, or after a power failure or unplugging of the cord if not), the unit reverts to SOURCE and PRE, the VOLUME will come on muted and then will unmute to about the -15-dB level, and EXPANSION, TRANSITION LEVEL, and IMPACT RESTORATION all will be centered at about their mid-, or 50-percent, settings. One reason for putting the 4BX in one of your other components' switched jacks, if you don't care about not maintaining any of your 4BX function settings, is that then the 4BX will be turned on and off with your system, and you won't get in the habit of using its own OFF and potentially causing sudden level changes.

- F IMPACT RELEASE RATE.** This control affects the rate (speed) at which impact restoration decreases. That is, the *end* of the attack may be made to die more and less quickly. There's no one correct setting for all music, just as there's no perfect all-purpose setting of the front-panel IMPACT RESTORATION, but you'll probably be able to find one position that suits most of your listening. Much popular music benefits from a faster reduction of its transients' decay (turn the control clockwise); the rhythmic drive is enhanced appropriately. Such a setting,

*Also called TAPE REC, REC(OUT), TO TAPE REC, TO TAPE IN(PUTS), (OUT) TO TAPE, TAPE OUTPUT, etc.; there probably are others.

**Also called PLAY, TAPE PLAY, PLAYBACK, (IN) FROM TAPE, FROM TAPE OUT(PUTS), etc.; others here too, probably.

however, may make gentler, longer-phrased music sound a little out of breath or sometimes staccato and jabbing (e.g., piano), so a slower release rate is more suitable, to preserve the proper spaciousness. And these are just the extremes of music. Experiment to find what sounds best to you most of the time; the factory setting is just a starting point. The control is easily turned with a small flat-bladed screwdriver, such as often come with phono cartridges.

- G HF TRANSITION LEVEL.** This control raises and lowers the transition level (see the *Front Panel* discussion) of the high band only, the band most likely to require changing for different kinds of music and speakers. Altering this band's transition level means increasing and decreasing the high treble, the upper-range brightness, of the sound (above approximately 6 kHz). A lower transition level (turn the control clockwise) produces more upward expansion of the very high frequencies relative to the rest of the sound; a higher transition level (turn the control counterclockwise) does the opposite, taming the sound a bit (if it's hissy, for example) and providing more noise reduction.

The control is set at the factory for what we believe is typical program material, but feel free to adjust it to your musical tastes — violins don't need to sound as intense as cymbals, and dull or spitty recordings and broadcasts don't have to stay that way. When you do your experimenting, make sure that the 4BX is set at its EXPANSION midpoint (1.3:1 or above, say) and that the front-panel TRANSITION LEVEL, which governs the proportion of upward to downward expansion for all of the frequencies, is set such that the red and yellow LEDs in the MF and LF bands are lighting up about equally.

ABOUT IMPACT RESTORATION, EXPANSION, AND DYNAMIC RANGE

Music works largely through our anticipation of it: the pleasure of knowing, but not knowing precisely, what's going to happen next. Whether the form is fugue or blues, a rock refrain or Haydn's *Surprise* Symphony, the lasting fun comes from our expectations being satisfied — but not too predictably so. In a good piece of music, over time, the startling becomes familiar, even as the familiar stays startling.

This effect, this freshness, frequently is enhanced by the *attack* of a note or chord. Depending on the percussiveness of the instrument and/or on the loudness of the attack compared with what came just before, these initial transients have a considerable impact. It's not just that Haydn put surprises in his famous symphony's slow movement, it's the *nature* of their sound, an orchestral *sforzando* that comes delicately out of nowhere.

This is what the 4BX's unique impact-restoration circuit aims to do: to increase the snap, the immediacy of these musical attacks that enhance our anticipating. Many of these transients get clipped off or otherwise dulled and muted anyway during the recording or broadcasting process, because of the compressors and limiters that are customarily employed. But even if the peaks aren't blunted in the processing, virtually all reproduced music sounds as though at least some of its excitement is missing. Conventional dynamic-range expansion, as we shall see, recovers much of this, yet cannot restore the excitement altogether. So with impact restoration we have tried to bring back some of the heart-stopping, breathtaking quality of live performance. After you have experimented with different amounts of impact restoration for various kinds of music, we think you will agree.

As for dynamic range itself, it may be simply defined as the difference in level between the loudest and the softest sounds in any given musical performance or recording.

In a performance, the loudest sounds are limited only by the musician's ability to strike, bow, or blow into the instrument, by its own limitations (e.g., a pipe organ), or, with amplified music, by the amp/speaker system's ability to fill a given space loudly without objectionable distortion. True (instantaneous) peaks may be more than 15 dB* above the average level, so any measurements of the "maximum" levels really should reflect the instantaneous peaks achieved.

*The decibel is a unit that expresses relative difference in power or sound level. The figure of 1 dB is usually given as the smallest sonic change detectable by most people, although over a wide spectrum of music or sound and under controlled conditions, a third of this amount is detectable to many. The threshold of hearing (the point at which one no longer can hear anything even at the most sensitive frequency range of 1-3 kHz, in the upper midrange/lower treble) is approximately "0-dB SPL" (sound-pressure level, a standardized measurement), and the level at which most people put their hands over their ears is about 115-120 average SPL. Some can tolerate 130-dB-SPL averages, which are harmful over time; others leave the room at 110; the dynamic range of human hearing thus is customarily said to be around 120 dB. Note that the relationships among SPL terms are widely misunderstood and misidentified. If the true (instantaneous) peaks are around 115-dB SPL, then the standard fast readings of maxima are about 103-106 — and these are often labeled "peaks" even within the audio world, especially in discussions of power-amplifier requirements for reproducing conventionally measured fast maximum SPLs — and the average (slow readings) level is around 100-102 or so.

In a high-fidelity stereo system, the highest levels that can be reached likewise are determined by the entire system's ability to play the loudest parts of the music without distortion becoming objectionable. Often the source of this distortion is the strained amplifier(s) and loudspeakers, but it may come from the record player and/or stylus/cartridge or the tape deck, and frequently it's already present in the record, tape, or broadcast itself.

The softest sounds in a performance occur just after the musicians stop playing: the echo and reverberation of the music dying out in the hall. Surprisingly, this reverberance may still be heard even when its level is below the hall's own ambient noise — the ear has a remarkable ability to pick out wanted signals in the presence of a large amount of (unwanted) noise. Nonetheless, a convenient and conservative figure for specifying the softest sounds practical in a live performance is the level of background noise in the hall, weighted to take into account the ear's decreased sensitivity to low-level (soft) low-frequency sounds.*

The true peaks generated in a live performance can be up to 115 dB SPL for a full orchestra and somewhat higher for amplified music. At the other end, the background level (correctly weighted) of a quiet hall often is below 30 dB SPL. The difference, then, is around 90 dB, a useful figure for specifying the dynamic range of live unamplified music.**

Unfortunately, the two most popular forms of storing recorded music that are currently available — vinyl analog records and audio cassettes — have dynamic ranges much, much less than 90 dB. Conventional records do well to reach beyond 50-55 dB of dynamic range; the most carefully prepared "audiophile" pressings may have slightly over 65 dB (provided they're not dbx-encoded discs, which upon decoding offer more than 90 dB of dynamic range). And even the best metal-tape cassettes cannot reach 60 dB on their own, without a noise-reduction system. Clearly, the audio signal must be manipulated in order to fit the dynamic range of live music into the constricted limits of the popular storage media.

This manipulation almost invariably is accomplished by compressing the signal and/or riding the gain in the recording or broadcast: loud passages are reduced in level and soft passages are increased. The overall dynamic range is thereby restricted. More than 30 dB in dynamic range has to be gotten rid of in

*The well-known Fletcher-Munson curves, for single tones, have been superseded by those of a number of researchers. Among the most widely quoted current ones are those of S.S. Stevens, which still demonstrate this lessened sensitivity. For example, if a 2-kHz sound is at 95-dB SPL (loud orchestral music), a 50-Hz tone has to be at about 115-dB SPL to sound equally loud, a difference of some 20 dB. At lower levels, the difference is greater. A 2-kHz sound at 60-dB SPL (quiet chamber music) is equaled in loudness by a 50-Hz tone at 85-dB SPL, a difference of 25 dB (30 Hz has to be at 88-dB SPL to sound as loud). At levels below 60-dB SPL, which are common in the home, the relative differences are greater.

**If we remember that the ear can hear musical reverberations that lie below ambient noise, as mentioned, that many recording and performance situations are considerably quieter than 30-dB SPL at their best, and that background-noise figures tend to be aggregate, not readings of the sensitive spectra, it becomes clear that even 90 dB of dynamic range is not enough. Hence the need for digital recording systems of 110-dB dynamic range (and up), such as the dbx 700 series.

order for the soft sounds to be recorded or broadcast above the noise floor and for the loud sounds to stay below an unacceptable distortion level.

If we want to restore this lost dynamic range in listening to a recording or broadcast, an expander is required. The dbx 4BX does just that -- it enables a listener to recover substantial portions of the dynamic range missing on existing conventional recordings and during conventional broadcasts. It works by increasing the volume of high-level passages and decreasing the volume of low-level ones, the opposite of the compression and gain riding used to constrict the program in the first place. Since it splits the audio signal into three bands and processes each separately, the 4BX can expand compressed material without the usual artifacts -- audible clues -- that tell the listener that processing is taking place. By flexibly expanding the dynamic range of a compressed program -- not to mention re-creating and/or augmenting the impact of its transients -- the contrasts between loud and soft are restored and those of the original performance more closely approximated. All of which brings back much of the excitement and involvement of listening to music live.

In lowering the characteristic noise levels of tapes, records, and broadcasts and restoring the "punch" of loud moments and the whisper of quiet ones, a 4BX can give new life to old record and tape collections and can make FM broadcasts worth listening to closely. And used carefully with a dbx tape-noise-reduction system (such as the 222 or 224), a 4BX lets you make copies of records, FM broadcasts, and other tapes that actually sound better than the originals. With all of these capabilities, it probably will become one of the most valued components in your home music system.

TYPICAL HOOKUPS

Caution: be sure that the power is OFF on all equipment when you hook up your dbx unit. Further, turn your volume control all the way down before switching on the 4BX for the first time.

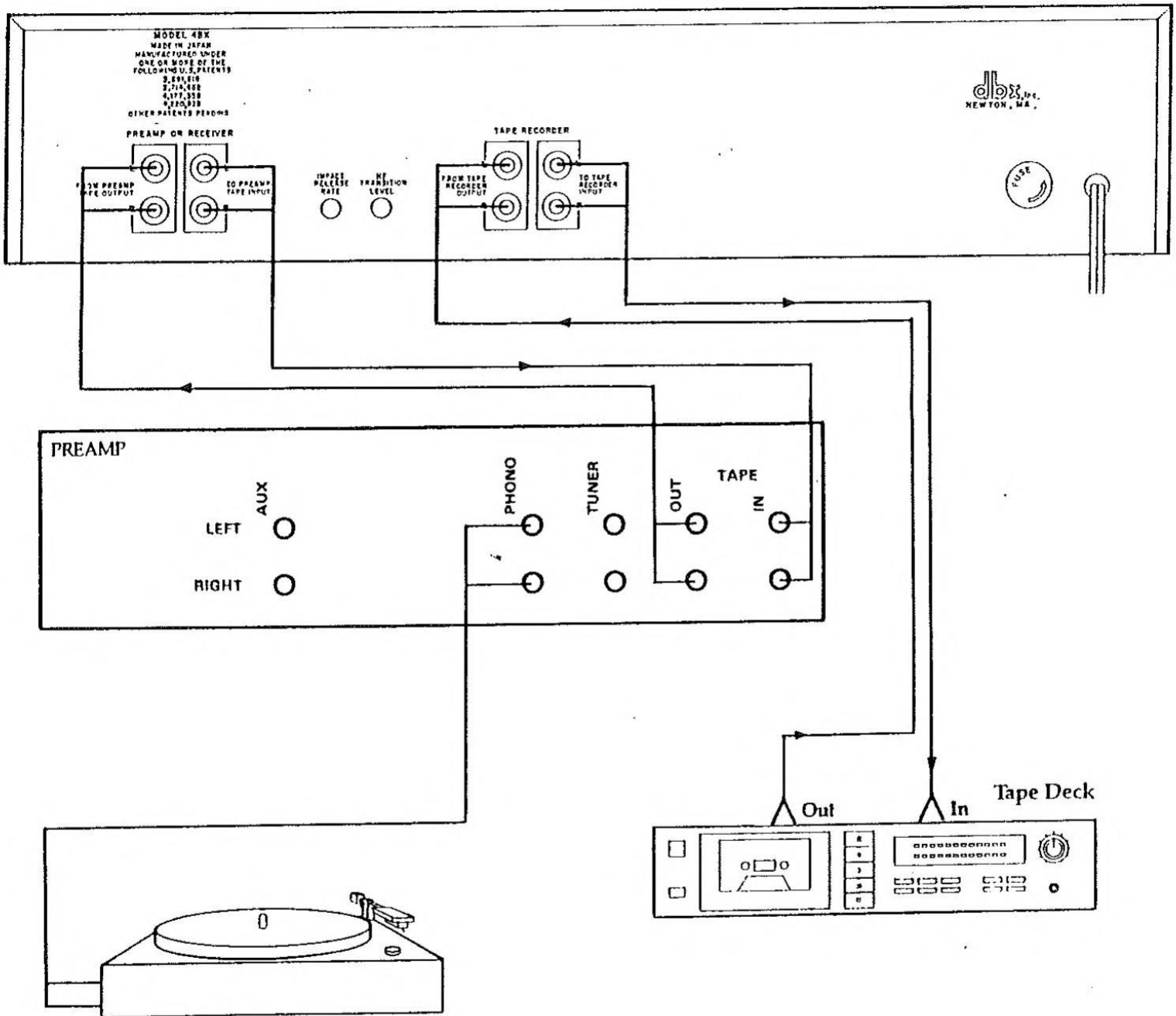

Basic Signal Connections

The 4BX goes between the preamp and the tape deck, in the former's tape-monitor loop, as shown. The tape deck then goes in the 4BX tape loop.

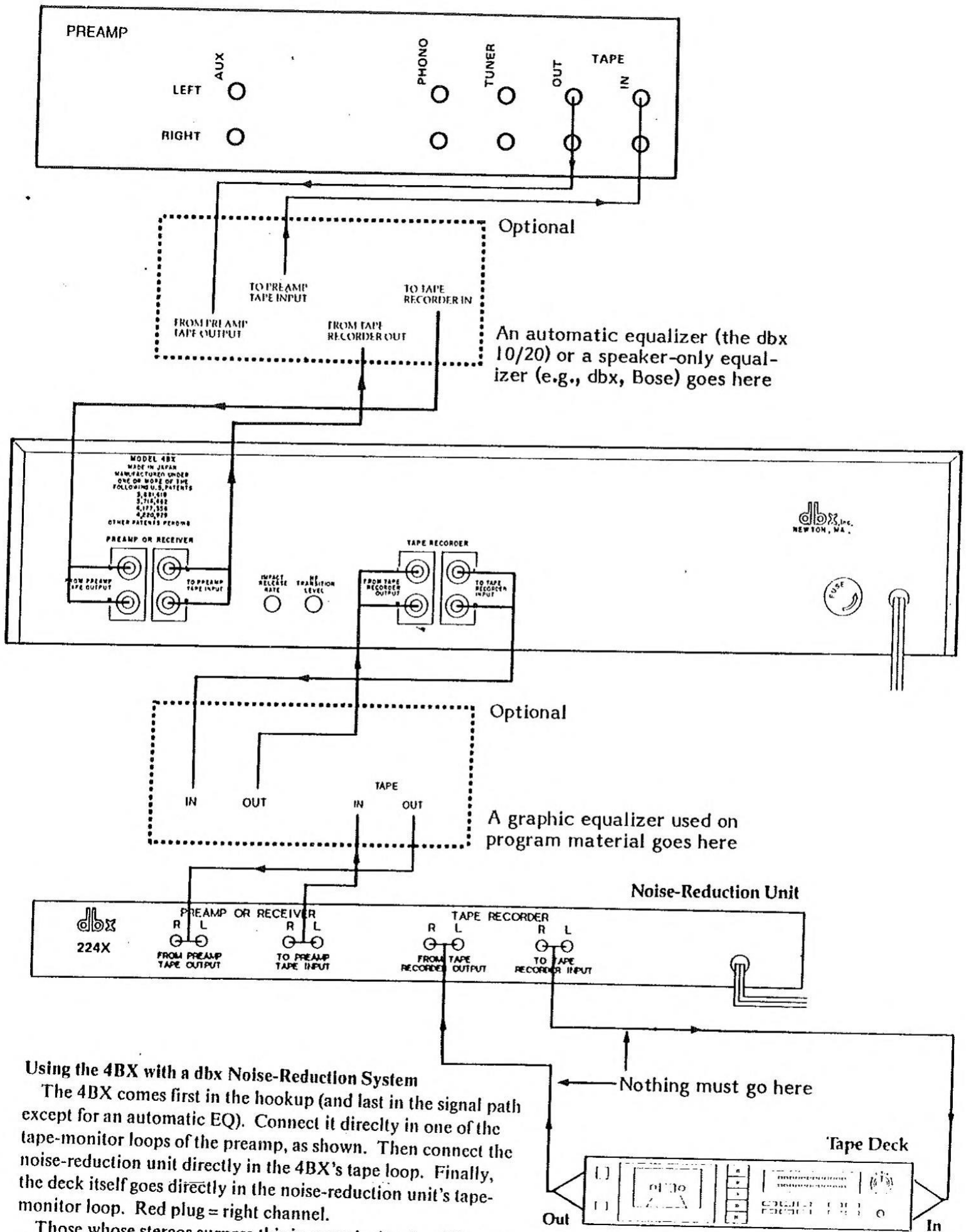

Using the 4BX with a dbx Noise-Reduction System
 The 4BX comes first in the hookup (and last in the signal path except for an automatic EQ). Connect it directly in one of the tape-monitor loops of the preamp, as shown. Then connect the noise-reduction unit directly in the 4BX's tape loop. Finally, the deck itself goes directly in the noise-reduction unit's tape-monitor loop. Red plug = right channel.
 Those whose stereos surpass this in complexity should investigate the dbx 200X and 400X Program-Route Selectors.

USAGE NOTES

In general, the amount of expansion to use is a matter of taste. However, some guidelines might prove useful as you experiment with different program material and different signal sources.

Classical music, for example, probably will benefit most from expansion at the lower half (left side) of the scale. You might want to start at 1.1:1 or so and range from 1.05:1 to 1.25:1 for most classical material. Using much more than this may make a lot of classical music surge unnaturally, for usually it has not been severely compressed.

Popular music, especially broadcast over FM stations, can use much more expansion much of the time — say, from 1.1:1 for material with good dynamic range to 1.4:1 and above for material whose loudness levels hardly differ. Sometimes this music gets so compressed that full expansion by your dbx unit won't be enough, really, but improvements still will be marked.

With jazz you might want to start somewhere between these classical and pop settings, although a quiet and well-recorded small acoustic combo won't need much expansion at all.

Non-stereo-LP sources (regardless of the program) often are badly constricted in dynamic range. We mentioned pop FM above, and the same frequently is true of video signals, from VCRs, video discs and cassettes, and TV tuners and station transmissions in the first place. Even classical music in such media usually sounds badly squashed, and a 1.4:1 setting might be the place to begin.

CAUTIONS

Any expander can make greater demands of your power amplifier and loudspeakers; after all, that's its job. On the other hand, because noise — rumble, hiss, and such — are reduced (expanded downward) by an expander, the amplifier is being used more efficiently. Whether a given amp is powerful enough isn't always easy to determine after an expander is added, for it depends on, among other things, loudspeaker sensitivity, the distortion characteristics of the amp, room size, and any changes in your listening-level habits.

Set for full expansion, the 4BX can expand a good recording to nearly 90 dB of dynamic range, and to realize fully such a range requires a hefty power amp and speakers that can take high power. Fortunately, such capacities in your components aren't essential for full enjoyment, and as we said in *Usage Notes*, more often than not you will be using your expander at less than the maximum, 1.5 setting and it will be on music that won't stress your equipment.

The point simply is that if your speakers and amplifiers cannot handle the widest dynamic range and the expander tries to drive them to that range, overdriving — the excessive distortion of amp clipping and/or speaker breakup — may be the result at the higher sound levels. If this occurs with good speakers and a reasonably large power amp, it probably will be noticed only with program material that has a good dynamic range to begin with, music that actually doesn't need much expansion. In which case what's called for is a reduction in the expansion setting, not more-powerful equipment.

Beyond this, when you also add impact restoration to the musical program, you will want to be especially careful that your equipment doesn't generate any unwanted transients. Pops and clicks from noisy controls and knobs (or, indeed, from a scratchy record) and the tick of the stylus setting down will all be boosted, just like musical attacks. In other words, don't drop the tonearm. To be safe, back off on impact restoration and/or turn the volume down whenever you change functions or begin to play a record.

SPECIFICATIONS

Expansion	From none (1:1) to 50% (1:1.5), each band
Impact-restoration gain.....	To potential +12 dB, each band
Dynamic range	Greater than 105 dB
Frequency response.....	± 0.5 dB 20 Hz – 20 kHz at no expansion
Total harmonic distortion (THD).....	Less than 0.15% at no expansion
Intermodulation distortion (IMD).....	Less than 0.1% at any setting
Equivalent input noise	90 dB below 1 V
Attack rates	Program-dependent, optimized for each band
Release rates	Linear expander program-dependent, optimized; impact restorer adjustable (see manual)
Transition-level range (mid-band)	30 mV – 300 mV
Volume-control range	-40 to +10 dB
Maximum input and output levels.....	6 V
Power requirements.....	See rear of unit
Dimensions	3 1/2" h \times 17 15/16" w \times 12 1/4" d (8.89 \times 45.56 \times 31.12 cm)
Weight (shipping).....	14 lbs. (6.4 kg)

NOTES

- 1) Specifications are subject to change without notice.
- 2) All voltages are rms (root-mean-square).
- 3) Dynamic range is defined as the difference between the maximum rms signal and A-weighted noise. All noise figures are A-weighted.
- 4) Frequency-response figures for noise-reduction units/decoders and expanders are for pink noise or typical music-program material.
- 5) The dbx 4BX is designed to be used with components whose output impedance is less than or equal to 10 k-ohms. It is designed to drive loads of at least 5 k-ohms in parallel with 1000 pF or less.
- 6) All measurements of intermodulation distortion (IMD) are made by the SMPTE (Society of Motion Picture and Television Engineers) method, that is, 60 Hz and 7 kHz mixed 4:1.
- 7) Units for use with line voltages other than nominal 117 V AC are available outside the USA; contact dbx Inc.

WARRANTY and FACTORY SERVICE

All dbx products are covered by a limited warranty (warranties for products purchased outside the USA are valid only in the country of purchase and the USA). For details, consult your warranty/registration card or your dealer/distributor.

The dbx Customer Service Dept. will help you use your new product. For answers to questions and information beyond what's in this manual, write to:

dbx Inc.
71 Chapel St.
Newton, Mass. 02195 USA
Attn: Customer Service

You also may call (617) 964-3210 during business hours (USA Eastern time). The Telex is 92-2522.

Should problems arise, consult your dealer or distributor. If it becomes necessary to have your equipment serviced at the factory, repack the unit, including a note with a description of the problem and the date of purchase, and send the unit freight prepaid to the above address, marking it Atten: Repairs.

FOR USERS IN THE UNITED KINGDOM

Important

The wires in the unit's mains lead are coloured in accordance with the following code:

Blue: Neutral
Brown: Live.

As the colours of the wires in the mains lead of this apparatus may not correspond with the coloured markings indentifying the terminals in your plug, proceed as follows:

The blue wire must be connected to the terminal that is marked with the letter N or coloured black;

The brown wire must be connected to the terminal that is marked with the letter L or coloured red.

Ensure that all terminals are securely tightened and that there are no loose strands of wire.

Warning

This unit must be protected by a 3-amp fuse, preferably using a fused plug.

Also, do not remove the cover without first disconnecting the unit from the mains supply.