

# How to build an Electro-Voice Component Speaker System. From the ground up.

One dollar



# Your best work can only you start with.

Building a speaker system from scratch is something most people wouldn't dream of doing! After all, it's a whole lot easier to drop by an audio store and drive home with a preassembled pair of speakers.

But if you're as serious about creating a custom system as we are about manufacturing the speakers that go in it, there are considerable rewards.

Maybe you're not completely sure what those rewards are. Or what's really involved in building your own system. That's what this brochure is all about. We'll show you how it's done, from choosing the right speakers to building the right enclosure to house them.

## A few good reasons to build your own system.

Component speakers are probably the least expensive way to get the live performance volume of a recording studio monitor into your living room.

That's because component speakers are significantly more efficient than preassembled systems. They're up to 10 dB more efficient than acoustic suspension speakers for example. Or put another way, they give you the same volume as using 10 times the amp power. So component speakers give you more performance for your money.

With component speakers, you can mix and match woofers, tweeters, and midrange drivers to fit your own needs. You don't have to rely on what a manufacturer selects, as you must with a preassembled system.

With E-V component speakers, you can begin with a single driver and have the option with our Building Block Kits of adding or replacing speakers to upgrade your system.

And component speakers give you the chance to design and build a cabinet to your own taste and needs. Anything short of Grandma's ice chest will do very nicely.

## Understanding the problem of enclosures.

Most component speaker systems require cabinets using ducts or ports. The problem is that designing a proper enclosure is more difficult than just cutting holes and mounting speakers in boxes. And while

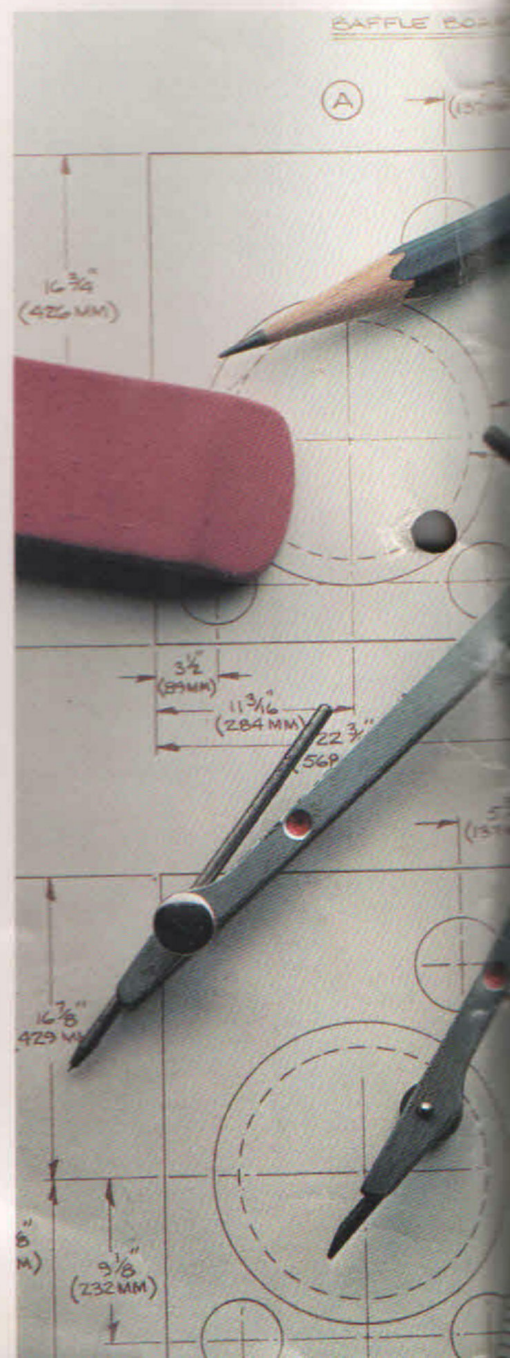

# be as good as the speakers

most companies offer cabinet plans, they don't tell you how the speaker *sounds* once it's installed. They give specs on how the speakers "sound" outside the cabinet, but that's like getting car mileage on a fifth wheel.

The truth is that you simply

can't get the full benefit of a custom music system with only a few cabinet plans yielding unpredictable results. Because in effect, you're paying for a speaker that may not meet its specifications.

The solution to this not inconsiderable problem was devised by an Australian named Thiele and an American named Small. They worked out mathematical formulas to *predict* bass response in *properly* designed vented enclosures. No one had ever done that before.

## **The payoff is a better speaker.**

The opportunity to build a more efficient speaker with better bass, and to offer a formula for obtaining *optimum* performance in almost any size enclosure was too good to pass up.

E-V immediately set out to computer design speakers that meet Thiele/Small parameters. Today the new E-V Component Speakers are the *only* ones available using this new technology.

The result is speakers and enclosures you know will work. Which means that for the first time, you know you'll get what you paid for. Because Thiele did the math and E-V did the engineering, you get speakers with predictable response.

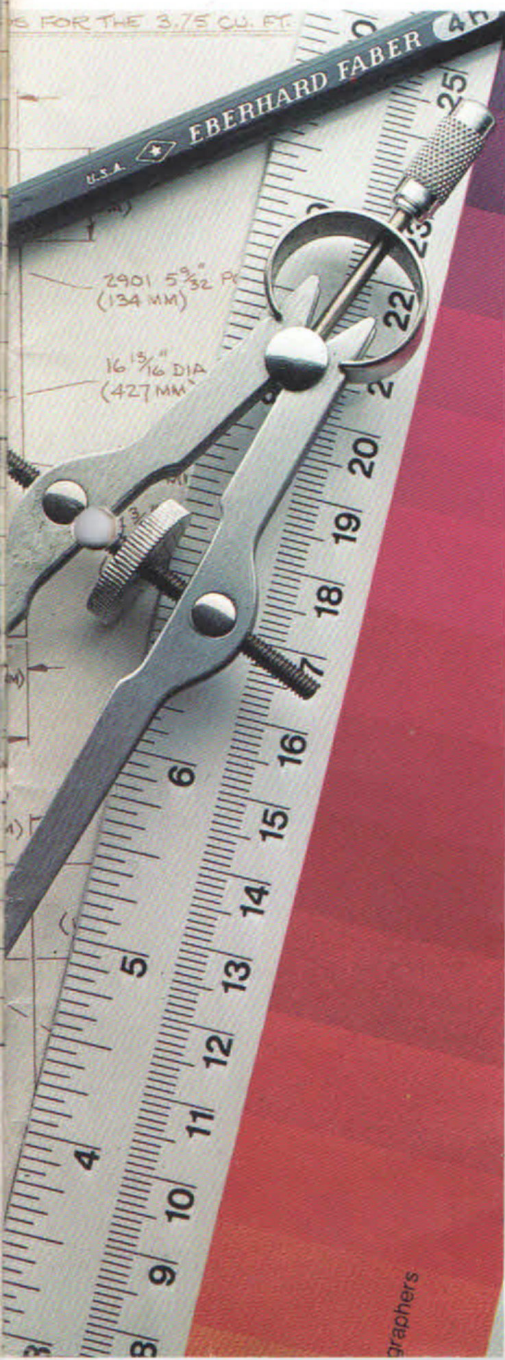

## Electro-Voice Speaker Construction

Building component speakers right is just as important as designing them right. Of course, some people take shortcuts in manufacturing. But when you cut corners in the way a speaker is made, you compromise the way it reproduces music. We don't cut corners at E-V. So we'd like you to see what goes into our speakers. Below, a cutaway view of the SP15A driver. One of the speakers you might put in your own system.

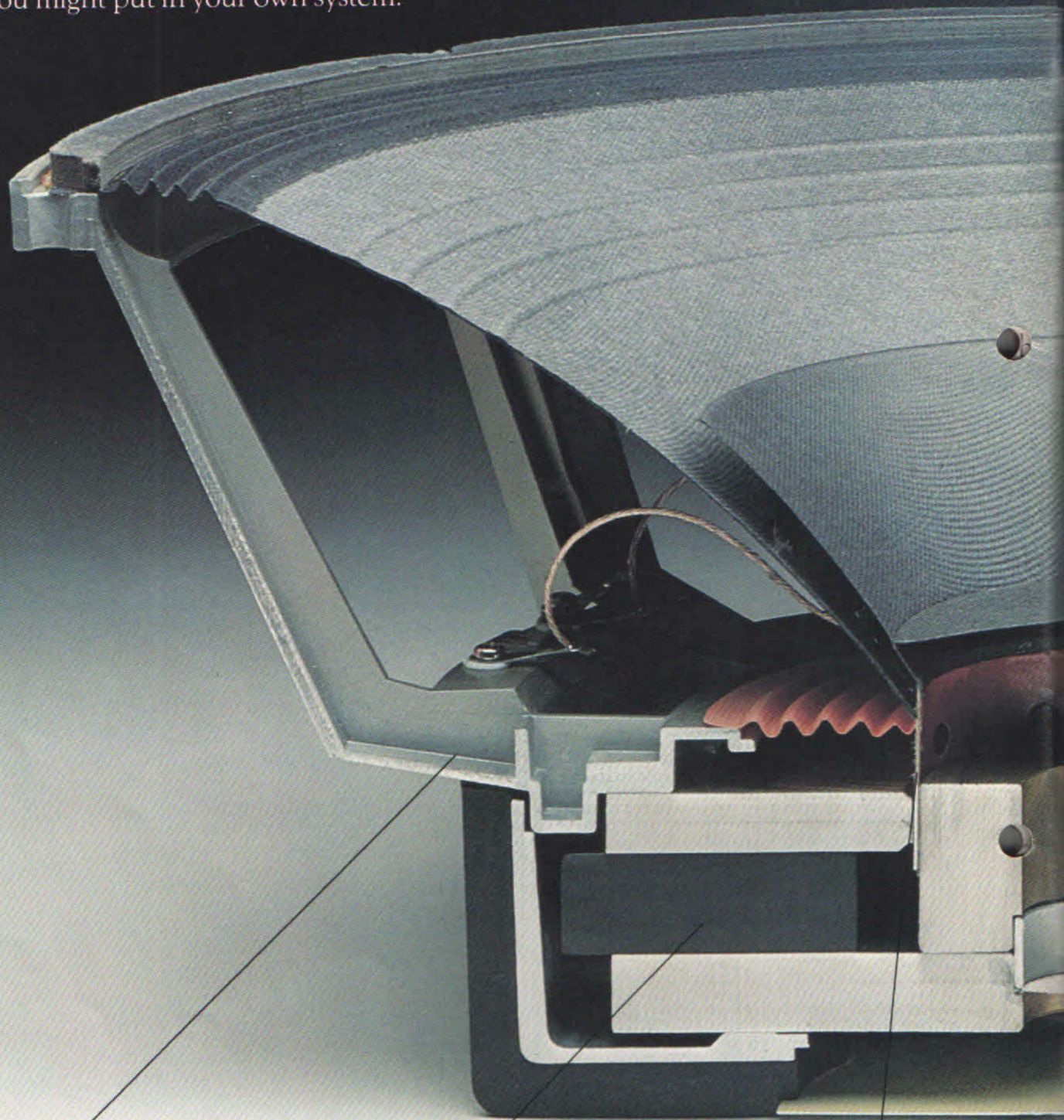

### The Frame

E-V manufactures its own rigid die-cast frame. Other speakers use flimsier frames stamped from sheet metal. Ours is less likely to be warped or damaged, either by the weight of the magnet or if you accidentally drop it.

### The Magnet

An old wives' tale says the bigger the better. Not true. Oversized magnets cause woofers to freeze at low frequencies. Undersized magnets cause serious distortion. E-V magnets are chosen for optimum size and weight, in this case, 78 oz. No more, no less.

### The Voice Coil

In the SP15A, E-V uses edgewound flat aluminum wire on the coil. Flat wire alone reduces amplifier requirements by 20%. The coils are wound by machines we designed, because nothing else available met our standards.

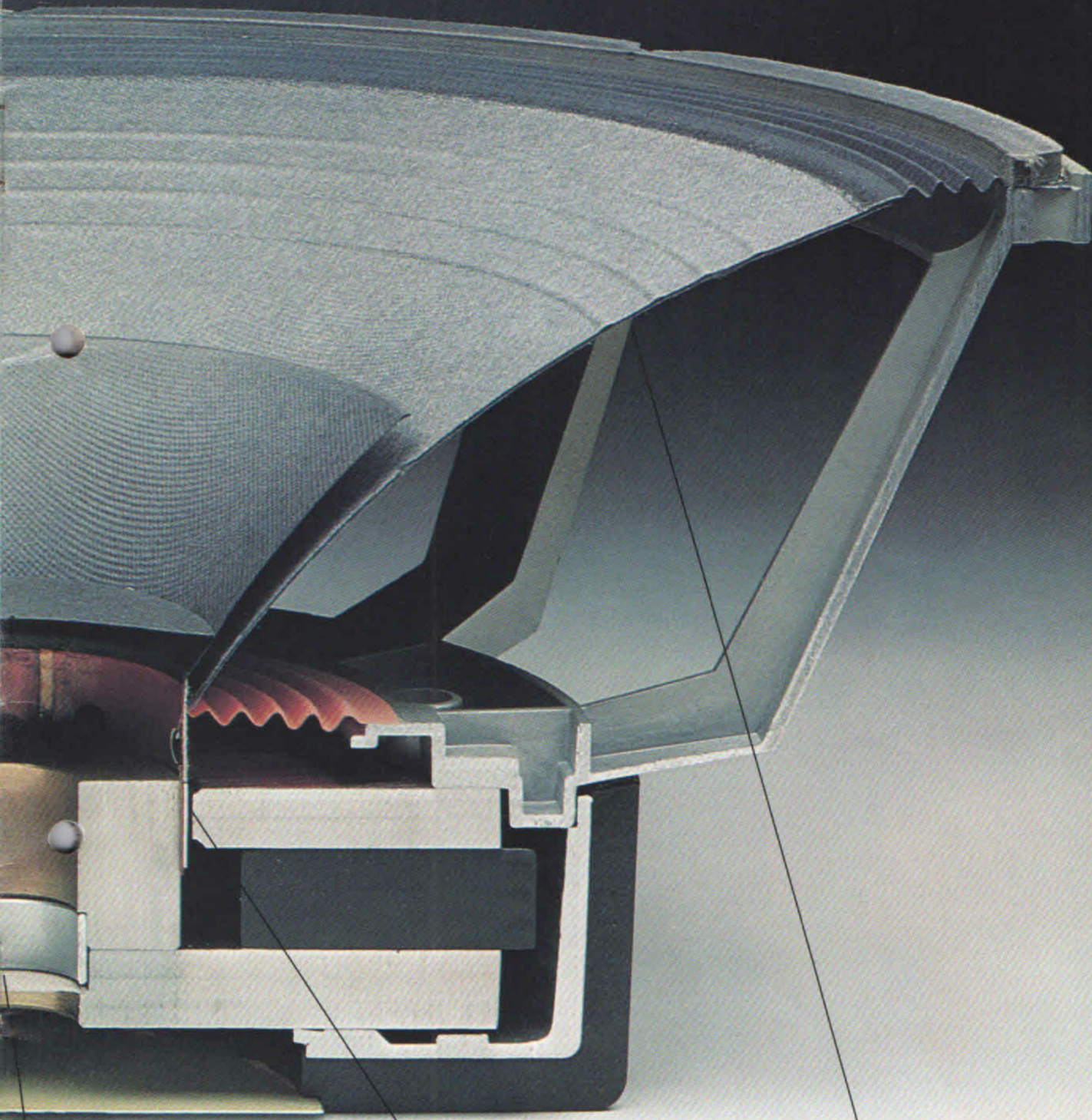

**The Vent**

E-V's optimized Thiele design calls for a "vent" in the back plate to release the high pressures developed by the cone. Additional venting takes place in the coil form.

**The Coil Form**

E-V's coil form is made from a high-temperature polyimide with exceptional power-handling capacity so you can play music loud. It's the same form we use in our professional rock music speakers.

**The Cone & Suspension**

E-V uses a specially-developed cone with optimum mass and stiffness. The suspension allows high bass output and also minimizes distortion caused by subsonic warp and rumble.

## Full-Range Speakers and Woofers

You should start your system by picking a woofer.

And there are some good reasons to pick one of these E-V models. First, their special design and the enclosure information gives more honest, predictable bass than any other component speakers you can buy.

Second, they're actually more than woofers. All these speakers from 15" down to 8" incorporate a specially-designed free-edge cone that dramatically improves the speaker's midrange and treble performance without compromising bass response.

So if you want to build your system a step at a time, you can use any of these speakers as a "full-range" driver.

SP12C

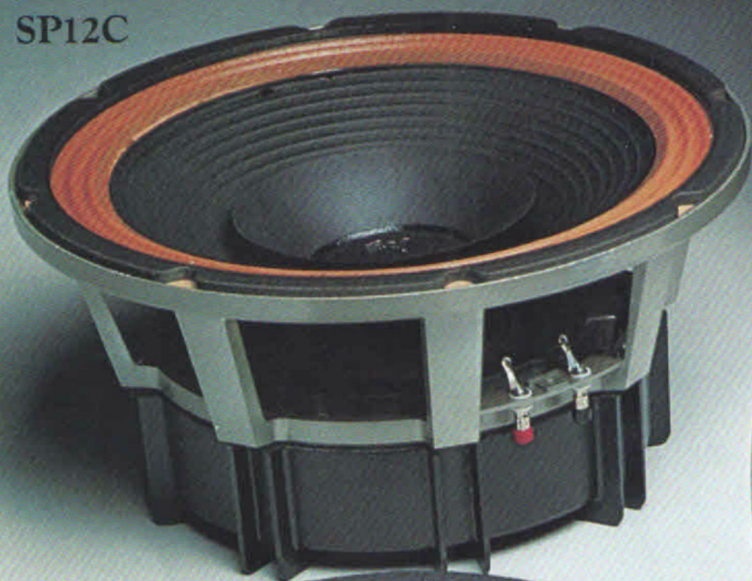

MC8A



12TRXC



SP12C

The SP12C is a moderately-priced speaker with a 22 oz. magnet and 12" cone. It is a high-efficiency speaker that has more than four times the low-bass output and more than twice the midband output of our SP8C. It's our least expensive way to get studio monitor performance at home.

MC8A

The 8" MC8A is our most economical speaker. Its lightweight moving system provides mid and high-frequency performance superior to many speakers with a separate tweeter. If you don't use an E-V Building Block Kit, the MC8A still gives accurate, full-range sound. Its shallow depth makes it ideal for wall mounting or as an extension speaker.

12TRXC

The 12TRXC is a two-way, full-range speaker. It combines an SP12C 12" woofer that develops superb low-bass and a T35 type horn tweeter which smooths treble response and improves dispersion. For improved midrange performance, we recommend using the 12TRXC with our 1823M midrange driver, 8HD horn, and X36 crossover network.

### 30W

The 30W is not a full-range speaker. Rather, it is designed to reproduce the lowest audible frequencies, where sound becomes a physical sensation. The 30W's motor mechanism is the most efficient of all E-V component speakers. The motor is connected to a cone of 562 sq. inches, the equivalent of nearly five 15" woofers! Needless to say, the sheer power of the bass is unbelievable. We recommend the 30W for sub-woofer applications at crossover frequencies below 200 Hz.

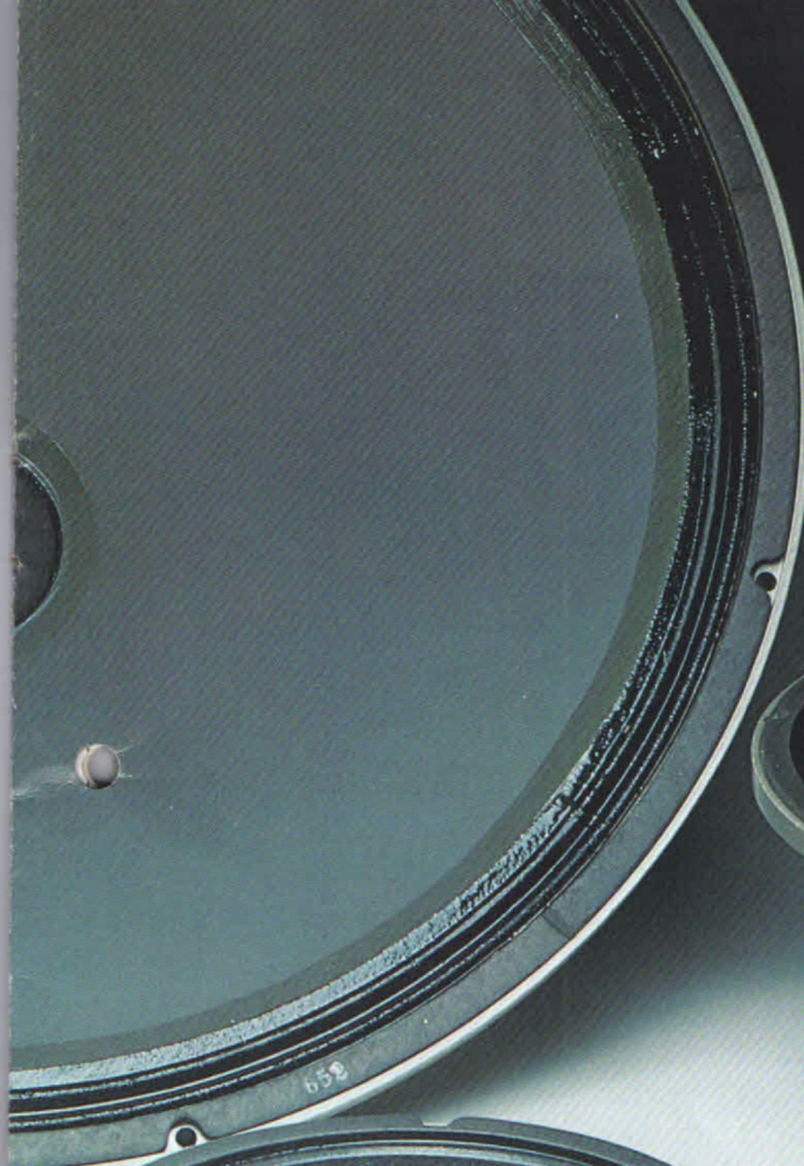

SP15A

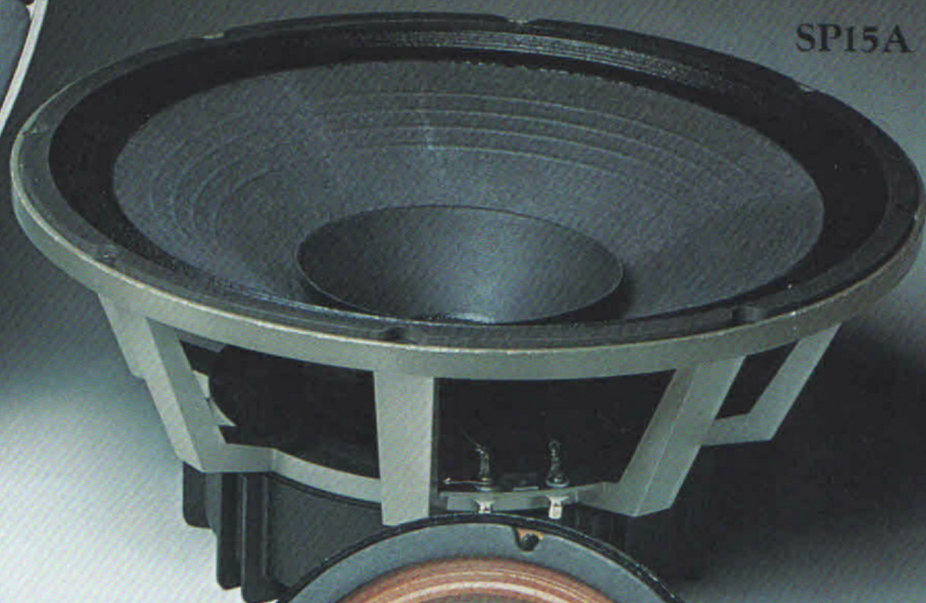

SP8C

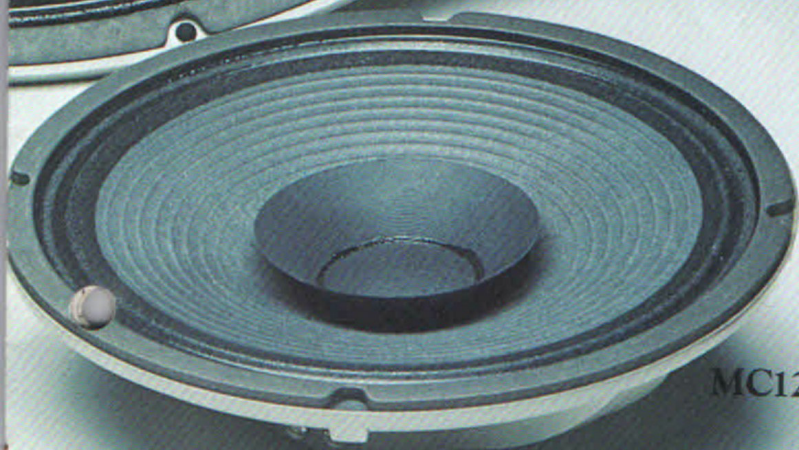

MC12A

### MC12A

Our MC12A is like the MC8A but has a 12" cone which produces lower bass because of its greater area and larger 2" voice coil. The MC12A is a good, economical choice if you want to listen to live performance levels.

### SP8C

The SP8C will give you the best bass in the smallest enclosure of any E-V component speaker. You can put it in an extremely small enclosure ( $\frac{3}{4}$  cu. ft.) and still get great bass. Its large 2" voice coil and linear cone excursion make it equal to many less sophisticated 12" speakers in bass response and maximum output ability. The SP8C is an ideal woofer for compact, multi-speaker systems using our BB1 or BB4A Building Block Kits.

### SP15A

Our SP15A is a maximum efficiency, maximum output speaker for those who demand the highest performance. It has a 78 oz. magnet and edgewound voice coil. It has nearly four times the midband output of our SP12C. And its bass output ability is exceeded only by our 30W.

# Horn Tweeters and Midrange Horn Drivers

If you plan to add a second speaker to an E-V woofer or full-range speaker, choose a tweeter first, then a midrange. The tweeter will make the most noticeable improvement in your system by providing balance between the low and high frequencies. The midrange smoothes response in the critical vocal range. Both will significantly improve stereo imaging and dispersion in your system. In addition to a driver, you will need a crossover and a level control. The crossover splits the audio signal and sends it to the proper speaker. The level control balances sound between your speakers. Each is available separately or in our complete Building Block Kits.

## 8HD Midrange Diffraction Horn

Our 8HD is designed for our 1823M Driver. It provides superior dispersion of midrange frequencies—fully 120° horizontal, 90° vertical which means the stereo image will be superb anywhere you sit and listen.

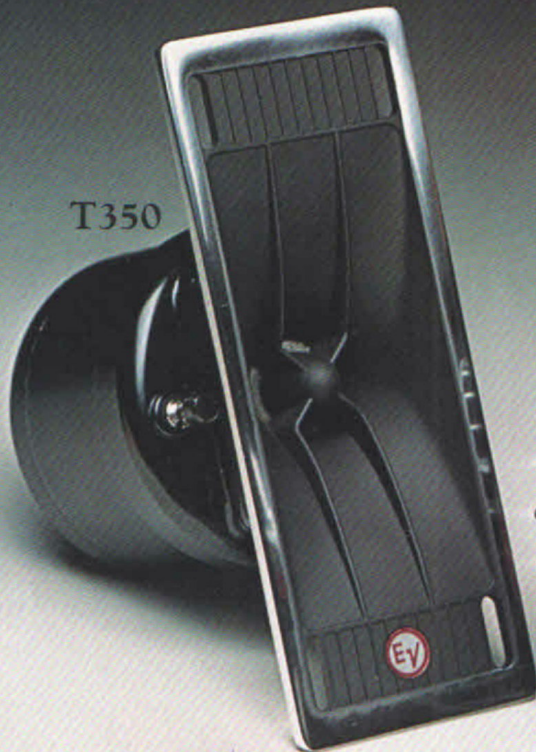

T350

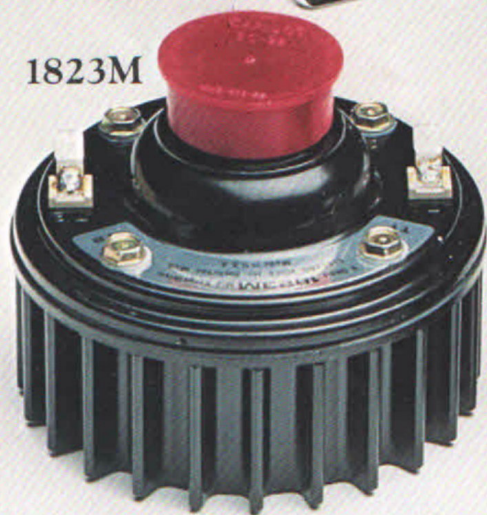
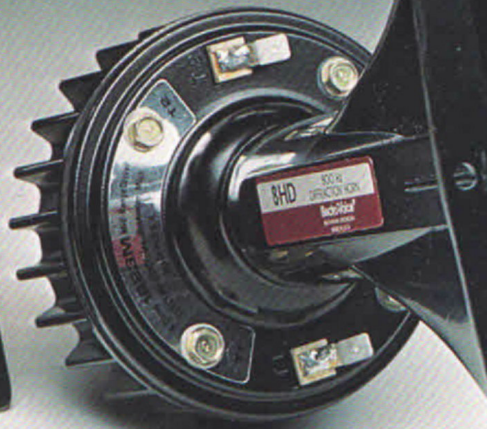

1823M



T35

## T35 High Compression Driver

Our T35 is probably the most widely used high-output tweeter in the world. It is a full 10-dB (10 times!) more efficient than typical direct radiator or dome tweeters. Its lightweight moving system provides precise definition of high frequencies. Its diffraction horn spreads the highs throughout your room for excellent stereo imaging.

## 1823M Midrange Driver

The 1823M is optimized for the critical midrange frequencies. It's the same driver we put in Sentry studio monitors. The 1823M has a lightweight aluminum voice coil for continuous duty applications (like a studio) that provides a unique combination of accuracy and live volume.

## T350 High Compression Driver

The T350 has more than twice the output of our T35. It gives better dispersion, clarity and a sense of spaciousness. The T350 delivers impressive highs and superior stereo imaging throughout your listening room.

# High-Frequency and Midrange Building Block Kits

We offer four Building Block Kits to extend and improve the mid and high-frequency response of your system. Each is compatible with our full-range speakers and 30W woofer. The kits include everything you need to complete your system without a hassle. Our BB series offers best performance, HF/MF series gives maximum value.

## BB4A Mid-Frequency Building Block Kit

The BB4A Kit uses our 1823M Driver and 8HD Diffraction Horn; X8 crossover network; AT38 variable level control; wiring harness and instruction book. The driver uses a dual-section, 12-dB-per-octave crossover for the smoothest, most accurate frequency response in the crossover range.

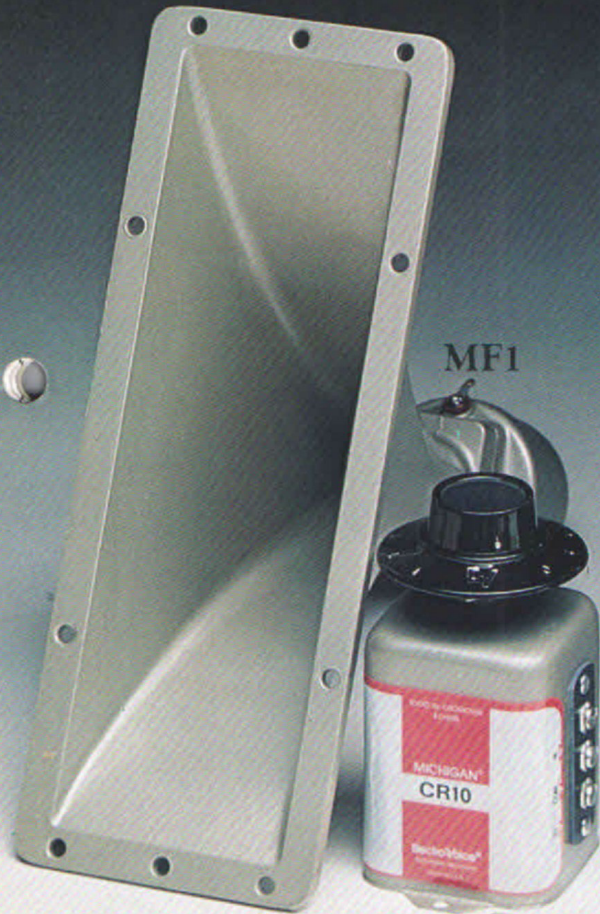

MF1



HF1



BB1

## MF1 Mid-Frequency Building Block Kit

The MF1 may be added to our "MC" series of full-range speakers. It has a single section, 6-dB-per-octave crossover. Our Kit includes driver, crossover, level control, wiring harness, instructions.

## HF1 High-Frequency Building Block Kit

Add the HF1 Kit to any E-V full-range speaker with the prefix "MC." The Kit includes tweeter with single section, 6-dB-per-octave crossover; level control, wiring harness, instructions.

## BB1 High-Frequency Building Block Kit

Our BB1 uses a dual-section 12-dB-per-octave crossover, for the smoothest, most accurate frequency response. The T35 tweeter is 3-dB louder at the same power as an HF tweeter. Kit includes X36 crossover network, AT38 level control, T35 tweeter, wiring harness, instructions.



IA

IIA

## All-Weather Speakers

Most component systems are stationary, to say the least. But sometimes a little portability is a nice thing to have. When you want music outside. Or in a room other than where your basic system is installed. If that's your requirement, these are speakers to do the job. The Musicasters are weatherproofed. Even fungus-proofed. They have a one-piece, glass-filled housing.

### Musicaster™ IA

The Musicaster IA is a vented speaker with a 12" dual-cone, wide range loudspeaker. Response: 50-11.5K Hz.

### Musicaster™ IIA

Musicaster IIA has the same 12" low-frequency driver as the IA. But we've added our T35 high compression horn tweeter to improve high-frequency response and dispersion. Response: 50-21K Hz.

## Component Accessories

### X8 Crossover Network

Our X8 is a dual-section, 12-dB-per-octave network. It's designed for use with our 1823M midrange driver. Crossover frequency: 800 Hz.

### X36 Crossover Network

The X36 is for use with our T35 and T350 tweeters. It is a 12-dB-per-octave, dual-section network. Crossover frequency: 3500 Hz.

### AT38 Level Control

An 8-ohm, continuously variable level control. The AT38 maintains constant impedance match. Use it to match levels on any of our drivers.

### STR Tweeter Protector

The STR is an electronic circuit which protects the tweeter from accidental damage at live performance listening levels. Use it with our T35 or T350 horn tweeters.

### SMH-1 Mounting Hardware

A kit for convenient front-mounting of the SP12C, SP15A, 12TRXC. The kit includes four die-cast mounting clamps, four slotted hex washer screws and four Teenuts. We think you'll find it quick and easy to install.

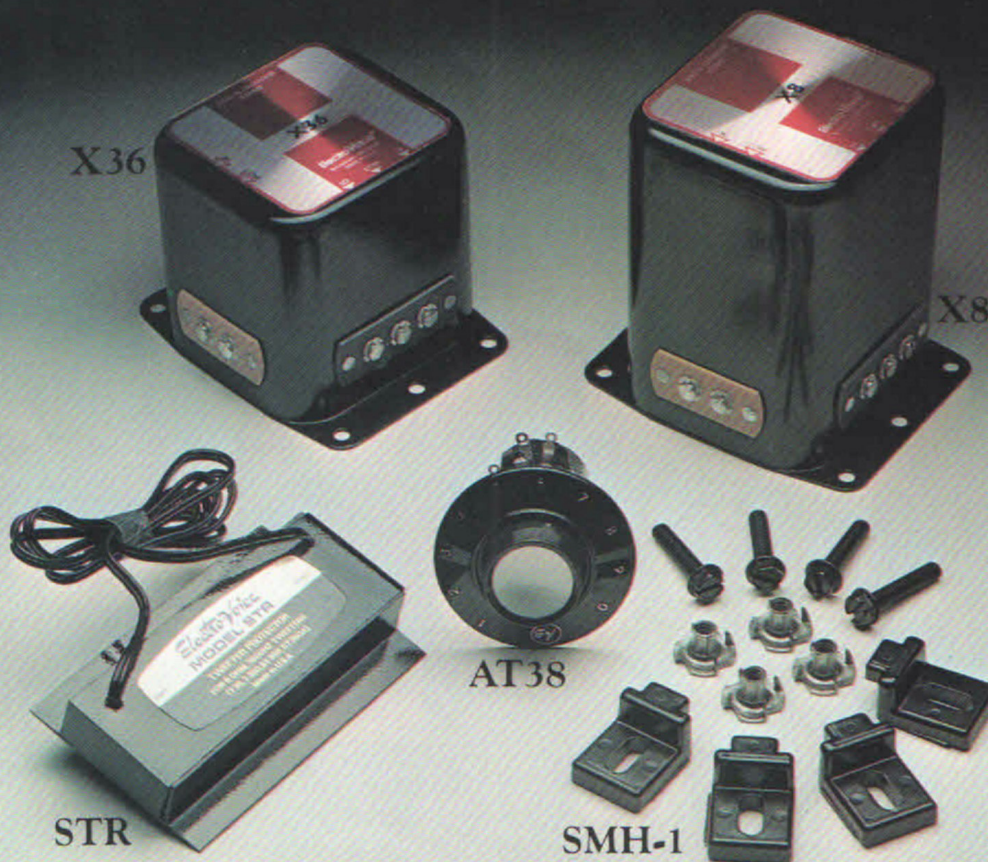

X36

X8

AT38

SMH-1

STR

# What to look for when you select your speakers.

By now we hope you understand a good bit about speakers. Particularly Electro-Voice component speakers.

But you're probably still not sure which of the speakers described in the last few pages really fit your needs. That's where the following speaker selection and enclosure charts come in handy. Using them, you can study all the relevant information and make the right choice.

## How Much Bass

Although it's hard to relate the numbers on the chart to the bass you hear, here are some suggestions. You'll get very balanced musical reproduction with a 3-dB-down point of 50 Hz. But if you want to *feel* the bass, then a speaker which gives you a 3-dB-down point at 40 Hz adds a very noticeable weight. In contemporary rock, this is the sound of a kick-drum, the synthesizer or the lowest tones of a direct-fed bass guitar. For classical music it's the orchestral bass drum or pipe organ fundamentals. A 3-dB-down point in the 30-35 Hz range provides a small further improvement, but to any serious enthusiast, it is significant.

## What About Dispersion

Dispersion is the angle over which the speaker radiates its sound. Generally, dispersion is said to stop when it drops 6 dB below the level directly in front of the speaker. Wide dispersion over a variety of frequencies creates a greater sense of depth and realism, and provides well-balanced sound throughout the room.

Dispersion is variable with frequency. So, for example, a woofer or full-range speaker will have a wider dispersion angle at low frequencies than at high frequencies. By adding mid or high-frequency E-V Building Block Kits, you can maintain excellent dispersion at all frequencies.

## Frequency Response

A speaker's frequency response tells you the range of sound it can accurately reproduce. That range is necessarily limited. A tweeter, for example, will reproduce high frequencies with clarity and brilliance (around 3,500-20,000 Hz), but will be unable to handle musical demands in the mid-range and low bass area below 3,500 Hz.

You'll note on the speaker selection and specification charts that response is stated " $\pm$  dB." This number is a range of how much response varies over the stated frequencies. Most speaker specs ignore such limits. Ranges like " $\pm 6$  dB" or better yet " $\pm 3$  dB" indicate smooth, accurate response. Although our full-range speakers have relatively wide response, adding mid or high-frequency Building Blocks will significantly extend the frequency response of your system.

## How Loud Is Loud

Before you select a speaker, you have to decide how loud you want it to play. We refer to loudness as the "sound pressure level" or "SPL"—as expressed in dB—and you will find an SPL for each speaker on the specification chart. However, there are some relationships which can help you appreciate different levels of loudness.

Background music you hear in restaurants is 60 dB. Normal conversation is 65 dB. A 90 dB average level of music will seem quite loud to most people. However, it falls short of the sound pressure levels of most live music. For example, "loud" classical music at a concert is only 80 dB. "Very loud," live classical music ranges from 90 dB to 100 dB with instantaneous peaks that range up to 120 dB. The sound pressure level of live rock music is something else. The "average" can be 115 dB!

We recommend that for average listening you design your system for 95 to 100 dB. You will notice on the charts that all our speakers give levels of 100 dB up. That's one of the benefits of working with a very efficient speaker system. You will also note that E-V has component speakers which can easily reach the levels of live rock.

## Three Famous Hi-Fi Myths

All too often speakers are sold on popular but rather inconsequential specifications. You'll find our specs for things like magnet size, cone diameter and free-air resonance, but we also want you to know why we consider them virtually meaningless.

Magnets and Cones. Everyone (but us) touts their heavyweight magnets and huge speaker cones. As we mentioned earlier, there are disadvantages to both oversize and undersize magnets and big, floppy cones. You can see this quite clearly on our enclosure chart. Compare the specs of a 15" speaker with an 8" speaker in the same size enclosure. Performance of the 15" is seriously compromised. Bigger isn't necessarily better. And only E-V tells you exactly how to build an enclosure that gives optimum performance from any size speaker.

Free-Air Resonance. Another hi-fi myth says that the lower your resonance, the better your performance. This may have some validity for acoustic suspension designs, but is irrelevant for Thiele design speakers which use the tuned vent to reproduce frequencies in the resonance range.

The charts to select your full-range, high and mid-frequency speakers or E-V Building Block Kits are on the next page.

# Speaker Selection and Specification Charts.

## Suggested Amplifier Power Ratings.

Power requirements are often expressed by other manufacturers in an unequivocal way (ex: "20 watts/channel"). True requirements vary depending on room acoustics and how loud you want to play your system. E-V offers five alternative ratings based on different sound pressure levels to help you more clearly evaluate your own power needs.

## Maximum Long-Term Average Sound Pressure Levels

These are useful maximums if you want to reproduce live SPL's, especially rock music. The basic impression of loudness is given by the "midband" specification, labeled SPL<sub>MF(max)</sub>. Speakers with low-frequency ability which matches their midband output, will allow reproduction of heavy bass at high volume.

## Power Capacity

A speaker's ability to handle power for an extended period of time is directly related to the voice-coil's ability to dissipate heat. Most people advertise big, impressive power capacity, but speakers that will actually handle more than 20 watts on a continuous basis are very rare. Large power handling claims are better interpreted as "may be used with amplifiers as powerful as \_\_\_\_\_." This is because short-term application of very high power is quite safe, since voice-coil temperature is not increased. Music is full of short duration peaks, at least 10 dB above the long-term average, even on highly compressed FM and records. Therefore, an amplifier with 10 times the long-term average power capacity of the speaker may be used, if full power is used only to reproduce program peaks and the average output is within the long-term capacity of the speaker.

## A Special Note on Tweeter Power Capacity

The light moving system required for good high-frequency reproduction limits tweeter power capacity to about 5 watts continuous. E-V tweeters are no exception. However, E-V horn tweeters are 20 times more efficient than the usual cone or dome tweeter. When adjusted for flat response in multi-way systems, the portion of the power which actually reaches the tweeter is a small fraction of the total power to the system. Because of its efficiency, it is doubtful that the tweeter's voice-coil capacity will ever be reached. The limiting factor on power capacity is almost always the woofer.

SPEAKER SELECTION AND SPECIFICATION CHART		FULL-RANGE SPEAKERS					LOW-FREQUENCY SPEAKER	TWO-WAY SPEAKER
		MC8A	MC12A	SP8C	SP12C	SP15A	30W	12TRXC
Cone Diameter: nominal		8"	12"	8"	12"	15"	30"	12"
Frequency Response: 1 Meter on axis, swept 1/2-octave random noise, half-space anechoic environment		42-20,000 Hz ±6dB	32-11,000 Hz ±6dB	41-12,000 Hz ±6dB	37-10,000 Hz ±6dB	34-8,000 Hz ±6dB	25-1,000 Hz ±6dB	37-18,000 Hz ±6dB
Low-Frequency Acoustic Power Output vs. Frequency: Below 100 Hz in typical enclosure	3-dB-Down	50 Hz	43 Hz	50 Hz	43 Hz	44 Hz	31 Hz	43 Hz
	10-dB-Down	37 Hz	30 Hz	36 Hz	32 Hz	34 Hz	24 Hz	32 Hz
Dispersion Angle: Included by 6-dB-down points, indicated octave bands of random noise, horizontal and vertical planes, anechoic environment	1,000 Hz	150°	115°	140°	120°	115°	—	120°
	2,000 Hz	75°	80°	115°	65°	60°	—	65°
	4,000 Hz	60°	90°	55°	45°	45°	—	70°
	8,000 Hz	30°	25°	30°	25°	50°	—	75°
	16,000 Hz	15°	15°	15°	15°	15°	—	65°
Sound Pressure Level: At 1 meter, 1 watt into nominal impedance, averaged over effective frequency range, anechoic environment		97 dB	97 dB	95 dB	100 dB	103 dB	100 dB	100 dB
Suggested Amplifier Power: Continuous average power per channel at 8 ohms, for indicated midband long-term average sound pressure levels, with instantaneous peaks 10 dB above average, in a typical living room (R=200 sq. ft.) Long-Term Average Power Capacity not to be exceeded.	Minimum, for 90 dB (Medium/Loud)	3.3 watts	3.3 watts	5.0 watts	2.4 watts	1.3 watts	.89 watts	2.4 watts
	Typical, for 95 dB (Loud)	10 watts	10 watts	16 watts	7.4 watts	4.0 watts	2.8 watts	7.4 watts
	Typical, for 100 dB	33 watts	33 watts	50 watts	24 watts	13 watts	8.9 watts	24 watts
	Practical Upper Limit, for 105 dB (Very Loud)	100 watts	100 watts	160 watts	74 watts	40 watts	28 watts	74 watts
	Maximum	120 watts (106 dB)	200 watts (108 dB)	250 watts (107 dB)	250 watts (111 dB)	500 watts (116 dB)	600 watts (118 dB)	250 watts (111 dB)
Maximum Long-Term Average Sound Pressure Levels: With instantaneous peaks 10 dB above average in a typical living room (R=200 sq. ft.)	Midband (SPL <sub>MF(max)</sub> )	106 dB	108 dB	107 dB	111 dB	116 dB	119 dB	111 dB
	Low Frequency in Recommended Enclosure (SPL <sub>LF(max)</sub> )	101 dB	102 dB	105 dB	110 dB	116 dB	119 dB	110 dB
Power Capacity at 8 ohms	Long-Term Average	12 watts	20 watts	25 watts	25 watts	50 watts	60 watts	25 watts
	Short Term (10 milliseconds)	120 watts	200 watts	250 watts	250 watts	500 watts	600 watts	250 watts
Suggested Range of Enclosure Volumes	Minimum	1.5 cubic ft.	2.9 cubic ft.	.74 cubic ft.	2.9 cubic ft.	3.7 cubic ft.	11.7 cubic ft.	2.9 cubic ft.
	Typical	2.3 cubic ft.	5.9 cubic ft.	1.2 cubic ft.	5.9 cubic ft.	7.4 cubic ft.	47 cubic ft.	5.9 cubic ft.
	Maximum	4.7 cubic ft.	23.3 cubic ft.	3.7 cubic ft.	23.3 cubic ft.	No Limit	No Limit	23.3 cubic ft.
Impedance (nominal)		8 ohms	8 ohms	8 ohms	8 ohms	8 ohms	8 ohms	8 ohms
Crossover Frequency		—	—	—	—	—	Below 200 Hz	3500 Hz
Voice Coil Diameter		1"	2"	2"	2"	2 1/2"	2 1/2"	2" & 1"
Free-Air Resonance		75 Hz	50 Hz	55 Hz	45 Hz	40 Hz	16 Hz	50 Hz
Magnet	Weight	10 oz.	13 oz.	1 lb., 6 oz.	1 lb., 6 oz.	4 lb., 14 oz.	9 lb., 4 oz.	1 lb., 6 oz.
	Material	Ceramic	Ceramic	Ceramic	Ceramic	Ceramic	Ceramic	Ceramic
Dimensions	Diameter	8 1/4"	12 1/4"	8 3/8"	12 3/16"	15 1/8"	29 3/4"	12 3/16"
	Depth	3 3/16"	3 1/2"	4 3/4"	6 1/8"	7"	13 13/32"	6 1/8"
Net Weight		4 lb., 2 oz.	5 lb., 7 oz.	7 lb., 2 oz.	10 lb., 1 oz.	20 lb., 2 oz.	34 lb.	11 lb., 5 oz.
Recommended Building Block Kit	High Frequency	HF1	HF1	BB1	BB1	BB1	—	—
	Mid Frequency	MF1	MF1	BB4A	BB4A	BB4A	—	BB4A with X36

SPEAKER SELECTION AND SPECIFICATION CHART	HORN TWEETERS			MIDRANGE DRIVERS & HORNS		
	TW35 (Part of HF1 only)	T35	T350	MR10 (Part of MF1 Only)	1823M & 8HD	
<b>Frequency Response:</b> With crossover, 1 meter on axis, swept 1/3-octave random noise, speaker mounted on flat baffle, anechoic environment	3500-15,000 Hz ±4 dB	3500-15,000 Hz ±3 dB	3500-15,000 Hz ±2 1/2 dB	1000-3500 Hz ±3 dB	800-3500 Hz ±3 dB	
<b>Dispersion Angle:</b> Included by 6-dB-down points, indicated octave bands of random noise, horizontal plane, speaker mounted on flat baffle, with long axis vertical 1, anechoic environment	1,000 Hz	—	—	170°	175°	
	2,000 Hz	—	—	165°	160°	
	4,000 Hz	155°	155°	115°	130°	
	8,000 Hz	90°	90°	80°	—	
	16,000 Hz	55°	55°	55°	—	
<b>Sound Pressure Level:</b> At 1 meter, 1 watt into nominal impedance, averaged over effective frequency range, anechoic environment	101 dB	104 dB	107 dB	103 dB	105 dB	
<b>Power Capacity:</b> At 8 ohms	Long-Term Average	5 watts <sup>2</sup>	5 watts <sup>2</sup>	5 watts <sup>2</sup>	60 watts	
	Short Term (10 milliseconds)	50 watts	50 watts	50 watts	600 watts	
<b>Impedance (nominal)</b>	8 ohms	8 ohms	8 ohms	8 ohms	8 ohms	
<b>Crossover Frequency</b>	3,500 Hz	3,500 Hz	3,500 Hz	1,000 Hz	800 Hz	
<b>Voice Coil Diameter</b>	1"	1"	1"	1"	2"	
<b>Magnet</b>	Weight	3.2 oz.	6.8 oz.	1 lb.	6.8 oz.	13 oz.
	Material	Alnico V	Alnico V	Alnico V	Alnico V	Alnico V
<b>Included in Building Block Kit</b>	HF1	BB1	—	MF1	BB4A	
<b>Dimensions: (hwd)</b>	5 1/4" x 2" x 2 3/4"	5 1/4" x 2" x 3 3/2"	7 1/4" x 2 7/8" x 4 3/8"	10 1/2" x 4" x 9 3/8"	1823M/8HD: 15" x 4 1/4" x 10 1/4"	
<b>Net Weight</b>	2 lb.	2 lb., 4 oz.	7 lb.	3 lb., 2 oz.	1823M: 4 lb., 14 oz. 8 HD: 2 lb., 10 oz.	

1. Except T350, whose horizontal dispersion is widest in the 8,000-16,000 Hz octave bands with its long axis horizontal
2. See comments on tweeter power capacity, preceding page.

## How to Choose the Right Enclosure

Now that you have the E-V speaker that meets your needs, you want to select the enclosure that will let it perform its best.

Here is where we have a real edge on other manufacturers.

We are the only speaker manufacturer who uses sophisticated computer analysis to determine the optimum enclosure design for component speakers. In fact, these comprehensive alternatives work *only* with E-V Thiele designed speakers. So you will not be building a "cut and try" speaker, or listening to the results of trial and error.

The selections that you make from the following suggestions and information will achieve optimum performance for the cabinet size and speaker you have chosen. Select your enclosure from the chart on the next page.

## Considerations for Designing The Speakers

Once you have decided the internal volume of your speaker, the shape of the cabinet is really up to you. There are only two things which you need to remember. You don't want extreme differences in the length and width of the cabinet. And the depth of the cabinet must allow the vent to operate freely, so it must have sufficient clearance. The length of the shortest side of the vent will do.

### Where to Put the Speakers and Vent in the Cabinet

Where you put the speakers on the front of the cabinet doesn't affect bass response, but close-to-ear-level mounting will provide the best mid and high frequency performance. Keep the speakers and the vent away from the corners and edges of the enclosure. The vent is usually placed on the front of the cabinet, but it can be on any other

side as long as its sound can reach the listener.

The accompanying illustration is one example of where to place the speakers and the vent.

## How to Build the Enclosure

The materials you use are important. They should be 3/4" voidfree plywood or particle board. Although smaller enclosures (approximately 2 cubic feet and under) may be made out of 5/8" material.

Make sure the joints between the pieces of wood are strong and well sealed. Simple butt joints secured with wood screws or nails and white glue are good.

Removable panels should be secured with wood screws and weather stripping tape.

If the sides are longer than 3 feet you should support them with internal glue blocks.

Inside the enclosure, use 1"-2" thickness of glass wool or similar acoustic absorptive material to prevent internal reflections from affecting mid-frequency performance. Line 3 adjacent walls (top, one side, and rear). Do not put absorptive material over or inside the port.

In the largest boxes, greater than 6 cubic feet, bracing is usually necessary to keep sympathetic vibrations from affecting the performance. Good bracing materials are 2" x 2" strips of lumber or 4" widths of 3/4" plywood, placed on edge. Secure these braces so that they divide the longest dimension of the panel in half vertically.

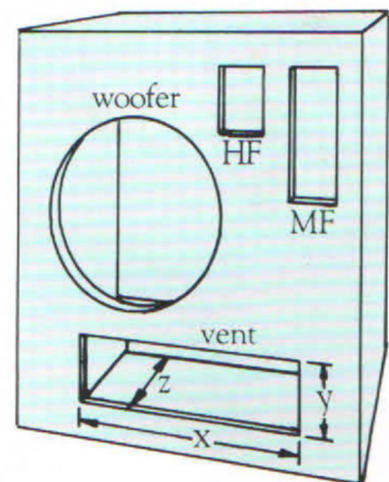

# How to use the enclosure selection

Because no other manufacturer offers all the information in this chart, it may, at first, seem complex. But if you understand a few fairly simple definitions, you'll discover how much more information and flexibility the chart allows.

If you don't need all that flexibility, you can simply use the highlighted "typical" area for the speaker you've selected. This information will allow you to build an enclosure which will provide excellent bass reproduction and a convenient size. You can even write to E-V for **specific plans** and our "Electro-Voice Guide to Speaker Enclosure Construction."

But if you'd like to know more, here's what the chart's terms mean.

**Net Internal Volume.** This is just the volume, in cubic feet, of the speaker enclosure. You can obtain it by multiplying the internal height, width and depth of the enclosure. If you measure in inches, dividing by 1728 will convert the volume to the cubic feet used in the chart. For even greater accuracy, you should subtract the space taken up by the speaker, crossover, etc. Generally, subtracting 5% from the total volume will yield the correct net enclosure volume.

**Low Frequency 3-dB-down point.** This is the frequency at which bass response is still strong, but at which it begins a gradual roll off. As the chart shows, low frequency performance varies dramatically depending on the volume of the enclosure. You should also notice that large speakers do not realize their full potential in small enclosures. In fact, if you must use a compact enclosure, a smaller speaker will provide better bass performance.

**SPL<sub>MF</sub> (max)** (Maximum mid-frequency sound pressure level). This is the maximum loudness the speaker can produce over a long period of time at midrange frequencies. As you can see, midband performance is unaffected by enclosure volume. Compare with SPL<sub>LF</sub> (max) below.

**SPL<sub>LF</sub> (max)** (Maximum low-frequency sound pressure level). This specification is measured like mid-frequency SPL above, but over lowest octave reproduced. The chart shows that the larger, more sophisticated speakers are capable of producing bass levels as high as their mid-frequency levels.

**Vent Area and Vent Length.** These specifications will not affect your choice of enclosure volume, but are essential when you start to build the enclosure. The area is the width multiplied by the height of the vent. Length is the depth of the vent into the box. See the sketch on the preceding page.

Now that you understand what the specifications are, here's how you could use them. Let's say you've picked the SP15A. Now you need to pick an enclosure. First, you should look at the SP15A's horizontal column and examine the low-frequency 3-dB-down points for all the enclosures listed. You can then choose the enclosure you need based on the bass response you want and the maximum enclosure size you can use in your room. Then you'll want to check the SPL<sub>MF</sub> (max) to be sure that it meets your needs. When that's done, you're ready to actually design your enclosure using the suggestions on the previous page.

Of course, if you have any questions or need some advice, your local Electro-Voice component speaker dealer can probably help. Or contact us directly at E-V.

	Net Internal Enclosure Volume <sup>1</sup> (in cubic feet)	Rec'd. Vol.	.585	.736	.927
		Acceptable Range	.521 to .655	.656 to .825	.826 to 1.03
MC8A	Low Frequency 3-dB-Down Point				
	SPL <sub>MF</sub> (max)				
	SPL <sub>LF</sub> (max)				
	Vent Area (XY)				
	Vent Length (Z)				
MC12A	Low Frequency 3-dB-Down Point				
	SPL <sub>MF</sub> (max)				
	SPL <sub>LF</sub> (max)				
	Vent Area (XY)				
	Vent Length (Z)				
SP8C	Low Frequency 3-dB-Down Point			60 Hz	54 Hz
	SPL <sub>MF</sub> (max)			107 dB	107 dB
	SPL <sub>LF</sub> (max)			107 dB	106 dB
	Vent Area (XY)			7.7 sq."	8.2 sq."
	Vent Length (Z)			5.4"	5.8"
SP12C & 12TRXC	Low Frequency 3-dB-Down Point				
	SPL <sub>MF</sub> (max)				
	SPL <sub>LF</sub> (max)				
	Vent Area (XY)				
	Vent Length (Z)				
SP15A	Low Frequency 3-dB-Down Point				
	SPL <sub>MF</sub> (max)				
	SPL <sub>LF</sub> (max)				
	Vent Area (XY)				
	Vent Length (Z)				
30W <sup>2</sup>	Net Internal Enclosure Volume <sup>1-2</sup> (in cubic feet)	Rec'd. Vol.			
		Acceptable Range			
30W <sup>2</sup>	Low Frequency 3-dB-Down Point				
	SPL <sub>MF</sub> (max)				
	SPL <sub>LF</sub> (max)				
	Vent Area (XY)				
	Vent Length (Z)				

<sup>1</sup> Use the Recommended volume when building from scratch. Use the Acceptable Range when working with an existing enclosure. Deviations within the Range will not produce measurable differences in performance.

<sup>2</sup> Note: for the 30W use the Net Internal Enclosure Volume listings immediately above the other charted 30W information. These volumes are 10 times those listed at the top of the chart.

# chart.

1.17	1.47	1.85	2.33	2.93	3.69	4.65	5.85	7.36	9.27	11.7	14.7	18.5	23.3		
1.04 to 1.30	1.31 to 1.64	1.65 to 2.06	2.07 to 2.60	2.61 to 3.28	3.29 to 4.13	4.14 to 5.20	5.21 to 6.55	6.56 to 8.25	8.26 to 10.3	10.4 to 13.0	13.1 to 16.4	16.5 to 20.6	20.7 to 26.0		
	60 Hz	55 Hz	50 Hz	48 Hz	44 Hz	43 Hz									
MINIMUM	106 dB	106 dB	106 dB	106 dB	106 dB	106 dB	MAXIMUM								
	103 dB	102 dB	101 dB	101 dB	100 dB	100 dB									
	11.5 sq."	11.5 sq."	11.5 sq."	24.3 sq."	24.3 sq."	35.8 sq."									
	2.7"	2.7"	2.7"	3.2"	3.2"	3.5"									
				58 Hz	52 Hz	48 Hz	43 Hz	39 Hz	37 Hz						
			MINIMUM	108 dB	108 dB	108 dB	108 dB	108 dB	108 dB	MAXIMUM					
				104 dB	103 dB	102 dB	102 dB	102 dB	102 dB						
				12.2 sq."	20.3 sq."	20.3 sq."	29.7 sq."	65.8 sq."	99.2 sq."						
				3.6"	3.0"	3.0"	3.4"	4.3"	4.9"						
50 Hz	45 Hz	40 Hz	37 Hz	35 Hz	31 Hz										
107 dB	107 dB	107 dB	107 dB	107 dB	107 dB	MAXIMUM									
105 dB	105 dB	104 dB	103 dB	102 dB	101 dB										
8.7 sq."	8.7 sq."	9.2 sq."	9.8 sq."	9.7 sq."	10.3 sq."										
6.2"	4.4"	4.8"	5.1"	3.5"	3.8"										
				57 Hz	52 Hz	48 Hz	43 Hz	38 Hz	34 Hz	31 Hz	27 Hz	25 Hz	23 Hz		
			MINIMUM	111 dB	111 dB	111 dB	111 dB	111 dB	111 dB	111 dB	111 dB	111 dB	111 dB		
				111 dB	111 dB	110 dB	110 dB	109 dB	109 dB	108 dB	107 dB	106 dB	106 dB		
				14.4 sq."	14.4 sq."	14.4 sq."	30.4 sq."	30.4 sq."	45.1 sq."	45.1 sq."	45.1 sq."	45.1 sq."	45.1 sq."		
				6.4"	4.4"	2.8"	3.4"	3.4"	3.8"	3.8"	3.8"	3.8"	3.8"		
				58 Hz	53 Hz	48 Hz	44 Hz	39 Hz	36 Hz	33 Hz	29 Hz	27 Hz			
			MINIMUM	116 dB	116 dB	116 dB	116 dB	116 dB	116 dB	116 dB	116 dB	116 dB	116 dB		
				116 dB	116 dB	116 dB	116 dB	116 dB	116 dB	116 dB	116 dB	115 dB	115 dB		
				55.7 sq."	59.0 sq."	59.0 sq."	62.5 sq."	66.2 sq."	70.2 sq."	78.8 sq."	78.8 sq."	78.8 sq."	78.8 sq."		
				7.2"	7.8"	4.9"	5.3"	5.8"	6.4"	4.5"	4.5"	4.5"	4.5"		
11.7	14.7	18.5	23.3	29.3	36.9	46.5	58.5	73.6	92.7	117	147	185	233		
10.4 to 13.0	13.1 to 16.4	16.5 to 20.6	20.7 to 26.0	26.1 to 32.8	32.9 to 41.3	41.4 to 52.0	52.1 to 65.6	65.6 to 82.5	82.6 to 103	104 to 130	131 to 164	165 to 206	207 to 260		
52 Hz	48 Hz	46 Hz	41 Hz	37 Hz	34 Hz	31 Hz	28 Hz	26 Hz	23 Hz	21 Hz	19 Hz	18 Hz	16 Hz		
119 dB	119 dB	119 dB	119 dB	119 dB	119 dB	119 dB	119 dB	119 dB	119 dB	119 dB	119 dB	119 dB	119 dB		
119 dB	119 dB	119 dB	119 dB	119 dB	119 dB	119 dB	119 dB	119 dB	119 dB	119 dB	119 dB	117 dB	116 dB		
Sealed	Sealed	Sealed	236 sq."	250 sq."	275 sq."	275 sq."	424 sq."	424 sq."	424 sq."	424 sq."	658 sq."	658 sq."	658 sq."		
-	-	-	9.9"	10.8"	7.2"	7.2"	8.5"	8.5"	8.5"	8.5"	10.3"	10.3"	10.3"		

Because of continuing design improvements, E-V reserves the right to modify, or replace any products listed herein.

# Electro-Voice®

Electro-Voice, Inc.  a Gulton company  
600 Cecil Street, Buchanan, Michigan 49107  
Phone 616/695/6831

Electro-Voice West  
7473 Avenue 304, Visalia, California 93277  
Phone 209/625-1330-1

In Canada  
Electro-Voice Division of Gulton Industries (Canada) Ltd.  
345 Herbert Street, Gananoque, Ontario  
Phone 613/382-2141

In Europe  
Electro-Voice, S.A.  
Romerstrasse 3, 2560 Nidau, Switzerland  
Phone 032-516833