

Dual

Zubehör
Accessories
Accessoires

873

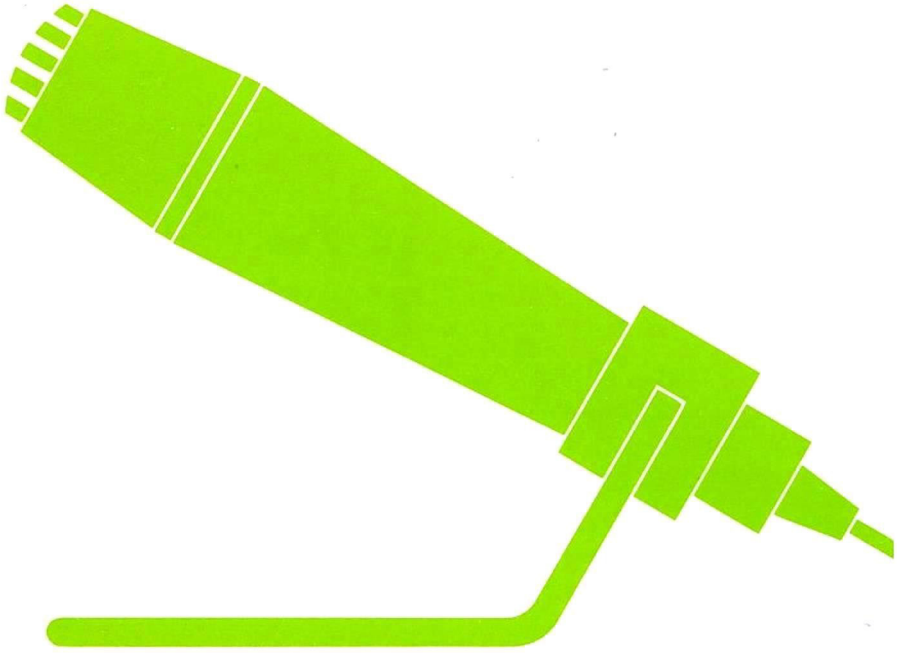
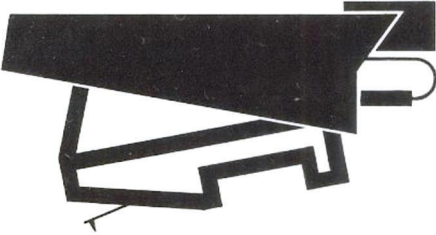

Für den Fachhandel



Original Dual Zubehör

bietet Gewähr für einwandfreie Wiedergabe und größtmögliche Schonung der Schallplatten.

Dual-Tonabnehmerköpfe, -Systeme und Abtastnadeln tragen den Dual-Schriftzug und sind nur in Kassetten und Plastikbehältern verpackt (Abbildungen) erhältlich.

Von der Verwendung von Nachahmungen muß abgeraten werden, weil wir sonst keine Gewähr für eine störungsfreie Funktion der Geräte übernehmen können.



Genuine Dual Accessories

assure excellent sound reproduction with utmost care given to the records.

Dual pick-up heads, cartridges and styli are identified by the Dual trade-mark and are available only packed in plastic containers (illustrations).

We strongly advise not to use imitations, as in such a case, we could not assure a proper function of the units.

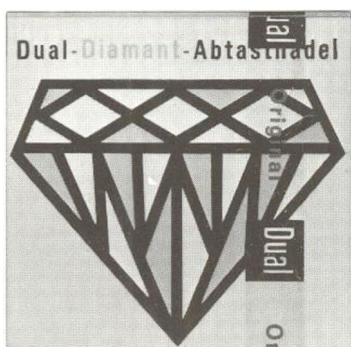

Les accessoires Dual d'origine

assurent la meilleure reproduction et une très grande protection des disques.

Les têtes – cellules – saphirs et diamants Dual portent l'empreinte de la marque Dual et sont toujours emballés dans de petites boîtes (fig.).

Nous déconseillons les imitations qui ne nous permettent pas de donner une garantie pour le bon fonctionnement de nos appareils.

Mit dem Erscheinen dieser Liste werden die Angaben und Preise der bisherigen Listen ungültig.

This catalogue replaces 872.

Cette nomenclature annule celle portant le No. 872.

Konstruktions- und Preisänderungen sowie Liefermöglichkeiten vorbehalten.

Alteration reserved.

Modifications réservées.

Bei den Notierungen handelt es sich um empfohlene Verbraucherpreise in DM incl. MWSt.

Die Buchstaben in den Preisspalten dienen zur Kennzeichnung der Warengruppen.

The merchandise groups are specified by capital letters.

Les familles d'articles sont spécifiées par lettres majuscules.



Service

Zubehör Accessories Accessoires

für

Phonogeräte
Phonokoffer
Tuner
Verstärker
Tonbandgeräte

for

Record Players
Portable Phonographs
Tuners
Amplifiers
Tape Recorders

pour

Tournes disques
Electrophones
Tuners
Amplificateurs
Magnétophones

Tabelle
Table
Table

4
7

8
12

13
15

16
17

PU/magn.

18
29

PU/Ker./Kr.

30
49















50

51

52
55

Service





56
59



Geräte-Typ Model Appareil	Abbildung Tonarm Illustration Tone Arms Figure Bras de pick-up	No.	Tonabnehmer Pick-up Pick-up	System System System	Nadel Stylus Pointe de lecture
701		229 074	TK 134	M 20 E	DN 350
1229		218 238	TK 129 TK 128	DM 103 M-E DM 101 M-G	DN 345 DN 340
1219		218 238	TK 129 TK 128 TK 126	DM 103 M-E DM 101 M-G M 91 MG-D	DN 345 DN 340 DN 330
1218		223 055	TK 157 TK 150	M 91 MG-D M 75 Typ D	DN 330 DN 325
1216		225 591	TK 120 TK 123 TK 201	M 75 Typ D DMS 200 CDS 700	DN 325 DN 201 DN 70
1215		220 976	TK 122 TK 120 TK 201	M 71 MB-D M 75 Typ D CDS 700	DN 325 DN 325 DN 70
1214/ T 503		223 017	TK 120	M 75 Typ D	DN 325
1214		223 017	TK 201 TK 181	CDS 700 CDS 650/6	DN 70 DN 6
1212		215 345	TK 122	M 71 MB-D	DN 325
1211		223 230	TK 181	CDS 650/6	DN 6
1210 A		223 230	TK 181	CDS 650/6	DN 6
1210		214 216	TK 181 TK 171 TK 155	CDS 650/6 CDS 640/6 CDS 630/5	DN 6 DN 6 DN 5
1209		217 904	TK 126 TK 122	M 91 MG-D M 71 MB-D	DN 330 DN 325
1019		201 082	TK 111 TK 115	M 44 M-G M 73 M-G	DN 305 DN 323
1016		207 420	TK 111	M 44 M-G	DN 305

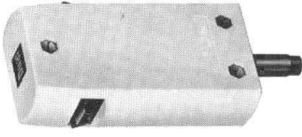
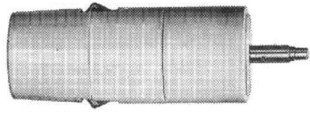



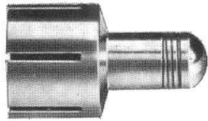

Abwurfsäule Automatic- Changer Spindle Tige d'éjection	Wechselachse Changing Spindle Axe changeur	Plattenstift Spindle Axe	Antriebsrolle Motor Pulley Galet d'entraînement		Konsole Mounting base Console	Haube Cover Couvercle
			50 Hz	60 Hz		
						CH 6, CH 20, CH 21, CH 5
AS 12	AW 3	201 101	218 275	218 276	CK 20, CK 21	CH 20, CH 21, CH 5
AS 12	AW 3	201 101	218 275	218 276	CK 20, CK 21	CH 20, CH 21, CH 5
AS 12	AW 3	201 101	218 273	218 274	CK 16, K 14	CH 20, CH 5, H 14
AS 12	AW 3	200 709	220 970	220 971	CK 16, K 14	CH 20, CH 6 CH 5, H 14
AS 12	AW 3	200 709	220 970	220 971	CK 16, K 14	CH 20, CH 6 CH 5, H 14
AS 12	AW 3	200 709	220 970	220 971	CK 16, K 14	CH 20, CH 6 CH 5, H 14 CH 9
AS 12	AW 3	200 709	224 847 (212 135)	224 848 (212 136)	CK 16, K 14	CH 20, CH 6 CH 5, H 14 CH 9
AS 12	AW 3	200 709	224 845 (212 115)	224 846 (212 116)	CK 16, K 14	CH 20, CH 6 CH 5, H 14
AS 12	AW 3	200 709	224 847 (212 135)	224 848 (212 136)	CK 16, K 14	CH 20, CH 6 CH 5, H 14 CH 9
AS 12	AW 3	200 709	224 847 (212 135)	224 848 (212 136)	CK 16, K 14	CH 20, CH 6 CH 5, H 14 CH 9
AS 12	AW 3	200 709	224 847 (212 135)	224 848 (212 136)	CK 16, K 14	CH 20, CH 6 CH 5, H 14 CH 9
AS 12	AW 3	201 101	218 273	218 274	CK 16, K 14	CH 20, CH 5, H 14
AS 9	AW 2	201 101	224 840 (204 503)	224 841 (204 511)	CK 16	CH 20, CH 5
AS 9	AW 2	201 101	224 838 (204 638)	224 839 (204 648)	CK 16	CH 20, CH 5

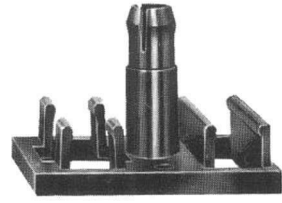
Geräte-Typ Model Appareil	Abbildung Tonarm Illustration Tone Arms Figure Bras de pick-up	No.	Tonabnehmer Pick-up Pick-up	System System System	Nadel Stylus Pointe de lecture
1015 F		207 503	TK 116	M 71 MB-D	DN 325
1015		207 503	TK 131	V 15/DAC	DN 311
1011			O 212 O 250	CDS 630/5 CDS 651/6	DN 5 DN 6
1010 S/A 1010 F		202 067	TK 151	CDS 630/5	DN 5
1010			O 212 O 250	CDS 630/5 CDS 651/6	DN 5 DN 6
1009		207 826	O 96 O 95	M 44 M-G Sp 1 B & O	DN 305 DN 301
430		229 572		CDS 650/6	DN 6
421		229 571		CDS 650/6	DN 6
420		220 467		CDS 650/6	DN 6
412		200 266		CDS 641/6 CDS 630/5	DN 6 DN 5
410 B		200 266		CDS 630/5	DN 5
400		206 548		CDS 520/3	DN 3
400 B		206 548		CDS 521/3	DN 3

Abwurfsäule Automatic- Changer Spindle Tige d'éjection	Wechselachse Changing Spindle Axe changeur	Plattenstift Spindle Axe	Antriebsrolle Motor Pulley Galet d'entraînement		Konsole Mounting base Console	Haube Cover Couvercle
			50 Hz	60 Hz		
AS 9	AW 2	200 709	224 845 (212 115)	224 846 (212 116)	CK 16	CH 20, CH 5 CH 9
AS 9	AW 2	200 709	224 838 (204 638)	224 839 (204 648)		CH 20, CH 5 CH 9
AS 9	AW 2	200 709	224 835 (200 764)	224 837 (207 353)		CH 20, CH 5 CH 9
AS 9	AW 2	200 709	224 835 (200 764) 224 847 (212 135)	224 837 (207 353) 224 848 (212 136)		CH 20, CH 5 CH 9
AS 9	AW 2	200 709	224 835 (200 764)	224 837 (207 353)		CH 20, CH 5 CH 9
AS 9	AW 2	200 709	224 840 (204 503)	224 841 (204 511)		CH 20, CH 5
			220 418	220 419	K 12	H 12
			220 418	220 419	K 12	H 12
			220 418	220 419	CK 11, K 12	H 12
			206 561	206 562		

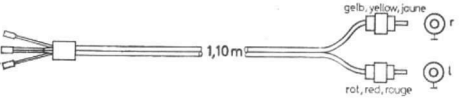
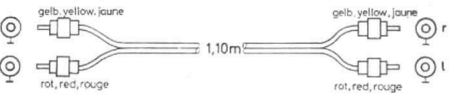
Geräte-Typ Model Appareil	Abbildung und Typ Illustration and type Figure et type	No.	Empfohlene Verbraucherpreise je Stück incl. MWSt. DM Warengruppe
1229 1219 1218 1216 1215 1214 1212 1211 1210 / A 1209	 <p data-bbox="397 443 733 524"> Abwurfsäule AS 12 Automatic Changer Spindle AS 12 Tige d'éjection AS 12 </p>	215 470	14,- E
1019 1016 1015 / F 1011 1010 / A / S / F 1009 / SK / SK 2 / F 1008 / A 1007 / A 1006 / A / M / AM	 <p data-bbox="397 790 725 880"> Abwurfsäule AS 9 Automatic Changer Spindle AS 9 Tige d'éjection AS 9 </p>	202 357	18,- E
1229 1219 1218 1216 1215 1214 1212 1211 1210 / A 1209	 <p data-bbox="397 1122 637 1205"> Wechselachse AW 3 Changing Spindle AW 3 Axe changeur AW 3 </p>	213 895	17,- E
1019 1016 1015 / F 1011 1010 / A / S / F 1009 / SK / SK 2 / F 1008 / A 1007 / A 1006 / A / M / AM	 <p data-bbox="397 1473 637 1563"> Wechselachse AW 2 Changing Spindle AW 2 Axe changeur AW 2 </p>	200 469	19,50 E
1005 1004 D 1004 S 1004 1003	 <p data-bbox="397 1794 637 1877"> Wechselachse AW 1 Changing Spindle AW 1 Axe changeur AW 1 </p>	206 676	13,- E

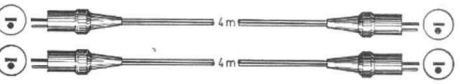
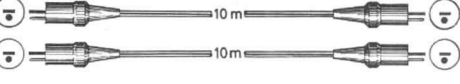
Geräte-Typ Model Appareil	Abbildung und Typ Illustration and type Figure et type	No.	Empfohlene Verbraucherpreise je Stück incl. MWSt. DM Warengruppe
1229 1219 1218 1209 1019 1016 1009 F 1009 SK 2 1009 SK	 <p data-bbox="388 477 863 499">Mitlaufstift · Single play spindle · Tige centrale</p>	201 101	4,- E
1216 1215 1214 1212 1211 1210 / A 1015 / F 1011 1010 / A / S / F 1009 1008 / A 1007 / A 1006 / A / M / AM	 <p data-bbox="388 880 663 902">Plattenstift · Spindle · Axe</p>	200 709	1,10 E
nach Bedarf	 <p data-bbox="388 1182 741 1205">Zentrierstück · Adapter · Centreur</p>	220 213	-,65 E
when required suivant les besoins	 <p data-bbox="388 1462 945 1552"> Halter für Plattenstift, Wechselachse und Zentrierstück Holder for spindle, changing spindle and adapter Support pour axe, axe changeur et centreur </p>	202 371	-,85 E

Geräte-Typ Model Appareil	Abbildung und Typ Illustration and type Figure et type	No.	Empfohlene Verbraucherpreise je Stück incl. MWSt. DM Warengruppe
nach Bedarf		207303	7,- E
		213833	8,50 E
		207102	7,- E
		207301	7,- E
when required		207299	8,20 E
		205255	8,- E
suivant les besoins		205344	11,- C
		220948	30,- C
		223139	19,- E



r = rechter Kanal
right channel
canal de droite





l = linker Kanal
left channel
canal de gauche

⊥ = Masse
mass
masse

Geräte-Typ Model Appareil	Abbildung und Typ Illustration and type Figure et type	No.	Empfohlene Verbraucherpreise je Stück incl. MWSt. DM Warengruppe
---------------------------------	--	-----	--

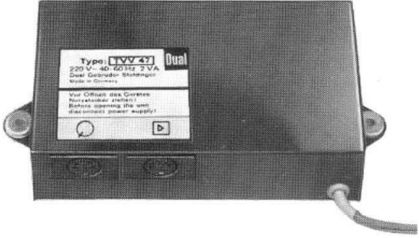
Kabel zum Anschluß monauraler oder 2-kanaliger Verstärkeranlagen, Rundfunk- oder Tonbandgeräte
 Cables for connecting monaural or 2-channel amplifiers, radios or tape recorders
 Câbles pour raccorder aux amplificateurs mono ou à deux canaux, aux radios ou aux enregistreurs

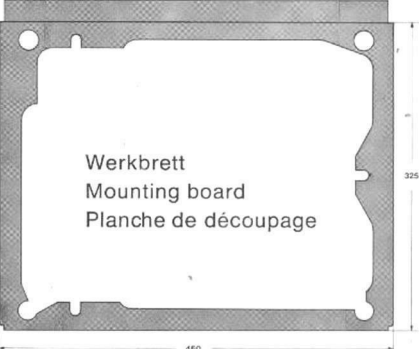
300 AV / 1 400 V H 400 V 410 V H 410 V 410 V / 1 H 410 V / 1 P 50 H 50 1007 V / 1 1007 AV 1010 V H 1010 V 1010 AV H 1010 AV 1010 SV H 1010 SV P 51, H 51 P 52, H 52 P 53, H 53 P 54		208 028	9,50 E
300 AV / 1 400 V H 400 V 410 V H 410 V 410 V / 1 H 410 V / 1 P 50 H 50 1007 V / 1 1007 AV 1010 V H 1010 V 1010 AV H 1010 AV 1010 SV H 1010 SV P 51, H 51 P 52, H 52 P 53, H 53 P 54		208 091	9,50 E
nach Bedarf		203 634	9,50 E
when required	2-Kanal-Tonabnehmerkabel als Meterware 2-channel pick-up cable – per meter Câble au mètre, à deux canaux pour pick-up	100 904	1,95/m E
suivant les besoins	1-Kanal-Tonarmleitung als Meterware 1-channel cable for tonearms – per meter Câble au mètre, à un canal pour bras de pick-up	101 003 rot, red, rouge 101 004 transparent	1,15/m E

Geräte-Typ Model Appareil	Typ und Abbildung Type and Illustration Type et Figure	No.	Empfohlene Verbraucherpreise je Stück incl. MWSt. DM Warengruppe
<p>Zum Anschluß von Phono-geräten mit Magnetsystem an Verstärker ohne entsprechenden Eingang</p> <p>For connecting phono-units with magnetic cartridge to amplifiers without corresponding input</p> <p>Pour raccorder des appareils phono-graphiques avec une cellule magnétique aux amplificateurs sans entrée speciale</p>	<p>TVV 47</p>  <p>Entzerrer-Vorverstärker · Equalizer preamplifier · Préamplificateur de correction</p>	<p>228 689</p>	<p>74,— D</p>
<p>1218 1216 1215 1214 1212 1211 1210 / A 1209 1019 1015 / F 1011 1010 / A / S / F 1009 / SK / SK 2 / F</p>	 <p>Werkbrett Mounting board Planche de découpage</p>	<p>Zum nachträglichen Einbau von Plattenwechslern in einen vorhandenen Montageboden älterer Modelle</p> <p>For later installation of record changers into existing mounting board of older models</p> <p>Pour le montage ultérieur de nouveaux changeurs dans les anciens combinés possédant des planches de découpage différentes</p> <p>229 396</p>	<p>14,50 E</p>
<p>701 1229 1219</p>	 <p>Werkbrett Mounting board Planche de découpage</p>	<p>Zum nachträglichen Einbau von Plattenwechslern in einen vorhandenen Montageboden älterer Modelle</p> <p>For later installation of record changers into existing mounting board of older models</p> <p>Pour le montage ultérieur de nouveaux changeurs dans les anciens combinés possédant des planches de découpage différentes</p> <p>224 102</p>	<p>16,— E</p>
<p>CL 16 CL 18 CL 20 CL 60 CL 80 CL 100 CL 150 CL 160 CL 180</p>	<p>LF 1</p>  <p>Lautsprecherfuß (2 Stück)</p> <p>Stand for Loudspeaker (2 pieces)</p> <p>Support pour haut-parleur (2 pièces)</p>	<p>215 453</p>	<p>106,— C</p>

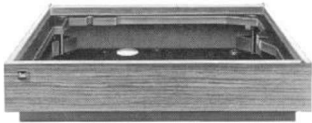
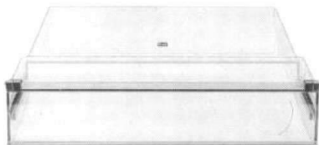
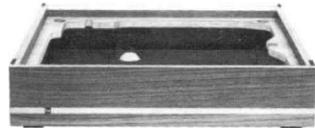
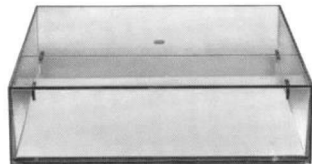
Geräte-Typ Model Appareil	Typ und Abbildung Type and Illustration Type et Figure	No.	Empfohlene Verbraucherpreise je Stück incl. MWSt. DM Warengruppe
701 1229 1219	CK 21  Konsole · Mounting base · Console CK 21/W weiß/white/blanc Maße/Dimensions: 420×362×92 mm	225 435 225 446	84,- C 96,- C
CK 21 CK 20 CK 16 CK 6 CK 5	CH 21  Abdeckhaube · Cover · Couvercle Maße/Dimensions: 417×365×102 mm	225 486	58,- C
701 1229 1219	CK 20  Konsole · Mounting base · Console CK 20/W weiß/white/blanc Maße/Dimensions: 420×363×94 mm	218 033 218 035	84,- C 96,- C
CK 21 CK 20 CK 16 CK 6 CK 5	CH 20  Abdeckhaube · Cover · Couvercle Maße/Dimensions: 420×355×117 mm	218 991	54,- C

Geräte-Typ Model Appareil	Typ und Abbildung Type and Illustration Type et Figure	No.	Empfohlene Verbraucherpreise je Stück incl. MWSt. DM Warengruppe
1218 1216 1215 1214 1212 1211 1210 / A 1209	CK 16  Konsole · Mounting base · Console CK 16/W weiß/white/blanc Maße/Dimensions : 420×365×78 mm	228 553 228 552	65,- C 77,- C
CK 6	CH 6  Abdeckhaube · Cover · Couvercle Maße/Dimensions : 418×353×70 mm	227 986	42,- C
CK 21 CK 20 CK 16 CK 6 CK 5	CH 5  Abdeckhaube · Cover · Couvercle Maße/Dimensions : 420×355×96 mm	203 211	42,- C
HR 2 CK 9 H 1010 V H 1010 AV H 1010 SV HS 10 HS 11 HS 12 HS 14 HS 15	CH 9  Klarsichthaube · Cover · Couvercle Maße/Dimensions : 353×300×86 mm	213 041	32,- C

Die Klarsichthaube CH 9 kann für folgende Geräte nicht verwendet werden :

The cover CH 9 is not to be used with the units :

Le couvercle CH 9 ne peut être appliqué aux appareils :





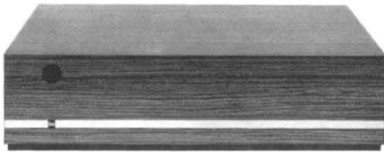
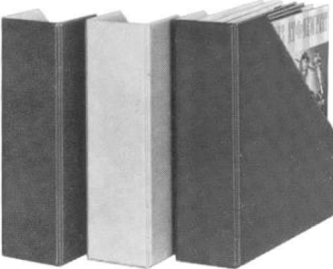
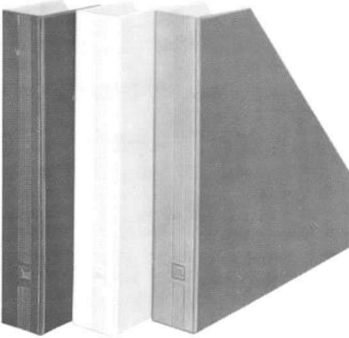

1009 / SK / SK 2 / F, 1019,

1209, 1212, 1215, 1216, 1218, 1219

Geräte-Typ Model Appareil	Typ und Abbildung Type and Illustration Type et Figure	No.	Empfohlene Verbraucherpreise je Stück incl. MWSt. DM Warengruppe
430 421 420	<p>K 12</p>  <p>Konsole · Mounting base · Console Maße/Dimensions : 309×234×71 mm</p>	224 414	25,- C
K 12	<p>H 12</p>  <p>Abdeckhaube · Cover · Couvercle Maße/Dimensions : 302×227×47 mm</p>	224 389	14,- C
1218 1216 1215 1214 1212 1211 1210 / A 1209	<p>K 14</p>  <p>Konsole · Mounting base · Console Maße/Dimensions : 361×308×78 mm</p>	222 547	29,- C
K 14 P 60 P 42	<p>H 14</p>  <p>Abdeckhaube · Cover · Couvercle Maße/Dimensions : 356×303×69 mm</p>	223 312	27,- C

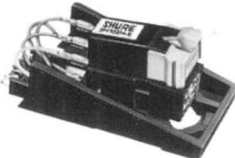
Geräte-Typ Model Appareil	Typ und Abbildung Type and Illustration Type et Figure	No.	Empfohlene Verbraucherpreise je Stück incl. MWSt. DM Warengruppe
<p>Schallplatten-Safe für zwanzig 30-cm-Schallplatten</p> <p>Record cabinet holds twenty records Ø 30 cm.</p> <p>Coffrait en bois peut contenir 20 disques 30 cm</p> <p>Maße/Dimensions: 420 x 358 x 108 mm</p>	<p>Schallplatten-Safe · Record cabinet · Coffret de rangement de disques</p> <p>CP 1</p> 	203 235	70,— C
	<p>CP 1 W weiß/white/blanc</p>	203 234	84,— C
<p>Disco-Box für zwanzig 17-cm-Schallplatten</p> <p>Disco-box for twenty 17 cm. records</p> <p>Disco-box pour 20 disques 17 cm</p> <p>Maße/Dimensions: 200 x 60 x 195 mm 3 Stück / pieces / pièces</p>	<p>Disco-Box · Disco-box · Disco-box</p> <p>DB 17-1</p>  <p>grau, rot, blau; grey, red, blue; gris, rouge, bleu</p>	220 986	20,— C
	<p>Disco-Box · Disco-box · Disco-box</p> <p>DB 17-2 rot, red, rouge DB 17-3 blau, blue, bleu DB 17-4 grau, grey, gris</p>	222 801 222 802 222 803	20,— C
<p>Disco-Box für fünfzehn 30-cm-Schallplatten</p> <p>Disco-box for fifteen 30 cm. records</p> <p>Disco-box pour 15 disques 30 cm</p> <p>Maße/Dimensions: 330 x 60 x 325 mm 3 Stück / pieces / pièces</p>	<p>Disco-Box · Disco-box · Disco-box</p> <p>DB 30-1</p>  <p>grau, rot, blau; grey, red, blue; gris, rouge, bleu</p>	220 996	31,— C
	<p>Disco-Box · Disco-box · Disco-box</p> <p>DB 30-2 rot, red, rouge DB 30-3 blau, blue, bleu DB 30-4 grau, grey, gris</p>	222 804 222 805 222 806	31,— C

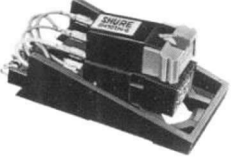
Geräte-Typ Model Appareil	Typ und Abbildung Type and Illustration Type et Figure	No.	Empfohlene Verbraucherpreise je Stück incl. MWSt. DM Warengruppe
Fahrbarer Phono-Tisch für Dual Stereo-Anlagen Movable phono-table for Dual Stereo Music Units Disco-table roulante pour Dual appareils stéréo			
nach Bedarf	PT 1  Maße/Dimensions : 440×424×363 mm PT 1 W weiß/white/blanc	220 747 220 749	96,- C 109,- C
when required	PT 2  Maße/Dimensions : 572×424×363 mm PT 2 W weiß/white/blanc	221 129 221 131	136,- C 154,- C
suivant les besoins	PT 4  Maße/Dimensions : 575×850×365 mm PT 4 W weiß/white/blanc	229 042 229 043	276,- C 308,- C

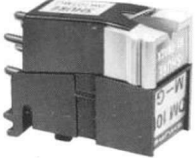
Geräte-Typ	Tonabnehmerkopf komplett	Kopf ohne System	Tonabnehmersystem mit Abtastnadel	Verwendungszweck Kenndaten
Model	Pick-up Head Complete	Head without Cartridge	Pick-up Cartridge with Stylus	Application Data
Appareil	Tête de lecture complète	Tête sans cellule	Cellule de pick-up avec pointe de lecture	Utilisation Données caractéristiques
701 1229 1219	TK 134 	TK 14 	M 20 E Ortofon  Stereo-Magnetsystem Magnetic stereo cartridge Cellule magnétique stéréo	Mikro riillen- und Stereo -Schallplatten Auflagekraft 0,75-1,2 p Micro - groove and stereo records Tracking weight 0.75-1.2 p Disques micro et stéréo . Force d'appui 0,75-1,2 p
	228 979	215 430	228 953	
	305,- E	7,- E	298,- E	
1229 1219 1218 1209	TK 129 	TK 14 	DM 103 M-E Shure  Stereo-Magnetsystem Magnetic stereo cartridge Cellule magnétique stéréo	Mikro riillen- und Stereo -Schallplatten Auflagekraft 0,5-1,25 p Micro - groove and stereo records Tracking weight 0.5-1.25 p Disques micro et stéréo . Force d'appui 0,5-1,25 p
	223 027	215 430	223 029	
	227,- E	7,- E	220,- E	
1229 1219 1218 1216 1215 1212 1209	TK 128 	TK 14 	DM 101 M-G Shure  Stereo-Magnetsystem Magnetic stereo cartridge Cellule magnétique stéréo	Mikro riillen- und Stereo -Schallplatten Auflagekraft 0,5-1,25 p Micro - groove and stereo records Tracking weight 0.5-1.25 p Disques micro et stéréo . Force d'appui 0,5-1,25 p
	223 026	215 430	223 028	
	182,- E	7,- E	175,- E	

Empfohlene Verbraucherpreise incl. MWSt.

Frequenzgang – Stereo- und Übersprechdämpfung, gemessen über Entzerrer-Vorverstärker TVV 46
 Meßplatte : DIN 45 541 (Schneidkennlinie 3180-318-75 μ s)
 Abspielgerät : Dual 1219

Frequency response, Stereo and crosstalk damping, measured with equalizer pre-amplifier TVV 46
 Test record : DIN 45 541 (recording curve 3180-318-75 μ s)
 Record player : Dual 1219

Courbe de fréquence, stéréo et taux de diaphonie, mesurés par l'intermédiaire du préamplificateur TVV 46
 Disque de contrôle DIN 45 541 (courbe de gravure 3180-318-75 μ s)
 Platine de reproduction : Dual 1219

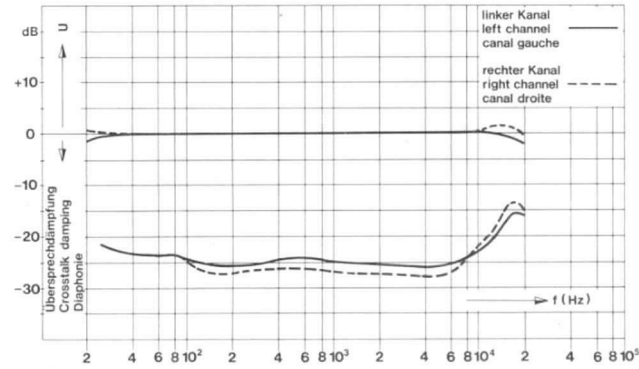

Abtastnadel

Stylus

Pointe de lecture

Spezial-Abtastnadel

Special stylus

Pointe de lecture spéciale

DN 350



schwarz
black
noir

M-Diamant = $6 \times 18 \mu$
 M-Diamond = 0.2×0.7 mil

228 961

160,- G

DN 345

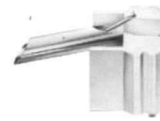

gelb
yellow
jaune

M-Diamant = $5 \times 18 \mu$
 M-Diamond = 0.2×0.7 mil

223 031

140,- G

DN 321

N-Diamant = 65μ
 N-Diamond = 2.7 mil
 für **Normal**ritzen-Schallplatten
 Auflagekraft 3 p

grün
green
vert

for **normal** groove (78 rpm) records. Tracking weight 3 p

pour disques **normaux**. Force d'appui 3 p

202 440

61,- G

DN 340



rot
red
rouge

M-Diamant = 15μ
 M-Diamond = 0.6 mil

223 030

98,- G

DN 321

N-Diamant = 65μ
 N-Diamond = 2.7 mil
 für **Normal**ritzen-Schallplatten
 Auflagekraft 3 p

grün
green
vert

for **normal** groove (78 rpm) records. Tracking weight 3 p

pour disques **normaux**. Force d'appui 3 p

202 440

61,- G

Empfohlene Verbraucherpreise incl. MWSt.

Geräte-Typ	Tonabnehmerkopf komplett	Kopf ohne System	Tonabnehmersystem mit Abtastnadel	Verwendungszweck Kenndaten
Model	Pick-up Head Complete	Head without Cartridge	Pick-up Cartridge with Stylus	Application Data
Appareil	Tête de lecture complète	Tête sans cellule	Cellule de pick-up avec pointe de lecture	Utilisation Données caractéristiques
1229 1219 1218 1216 1215 1212 1209	TK 126 	TK 14 	M 91 MG-D Shure  Stereo-Magnetsystem Magnetic stereo cartridge Cellule magnétique stéréo	Mikrorillen- und Stereo-Schallplatten Auflagekraft 1-1,5 p Micro-groove and stereo records Tracking weight 1-1.5 p Disques micro et stéréo . Force d'appui 1-1,5 p
	217 531	215 430	217 703	
	167,- E	7,- E	160,- E	
1218 1216 1215 1212 1209	TK 157 	TK 15  mit, with, avec Tracking Selector	M 91 MG-D Shure  Stereo-Magnetsystem Magnetic stereo cartridge Cellule magnétique stéréo	Mikrorillen- und Stereo-Schallplatten Auflagekraft 1-1,5 p Micro-groove and stereo records Tracking weight 1-1.5 p Disques micro et stéréo . Force d'appui 1-1,5 p
	223 035	223 036	217 703	
	170,50 E	10,50 E	160,- E	
1218 1216 1215 1212 1209	TK 150 	TK 15  mit, with, avec Tracking Selector	M 75 Typ D Shure  Stereo-Magnetsystem Magnetic stereo cartridge Cellule magnétique stéréo	Mikrorillen- und Stereo-Schallplatten Auflagekraft 2-3 p Micro-groove and stereo records Tracking weight 2-3 p Disques micro et stéréo . Force d'appui 2-3 p
	223 034	223 036	223 033	
	102,50 E	10,50 E	92,- E	

Empfohlene Verbraucherpreise incl. MWSt.

TK 15 mit Umschalt-Einrichtung zur Einhaltung des vertikalen Spurwinkels
TK 15 with Tracking Selector for maintaining correct vertical tracking
TK 15 avec «Tracking Selector», commutant l'angle de piste vertical

Frequenzgang - Stereo- und Übersprechdämpfung, gemessen über Entzerrer-Vorverstärker TVV 46
 Meßplatte : DIN 45 541 (Schneidkennlinie 3180-318-75 μ s)
 Abspielgerät : Dual 1219

Frequency response, Stereo and crosstalk damping, measured with equalizer pre-amplifier TVV 46
 Test record : DIN 45 541 (recording curve 3180-318-75 μ s)
 Record player : Dual 1219

Courbe de fréquence, stéréo et taux de diaphonie, mesurés par l'intermédiaire du préamplificateur TVV 46
 Disque de contrôle DIN 45 541 (courbe de gravure 3180-318-75 μ s)
 Platine de reproduction : Dual 1219

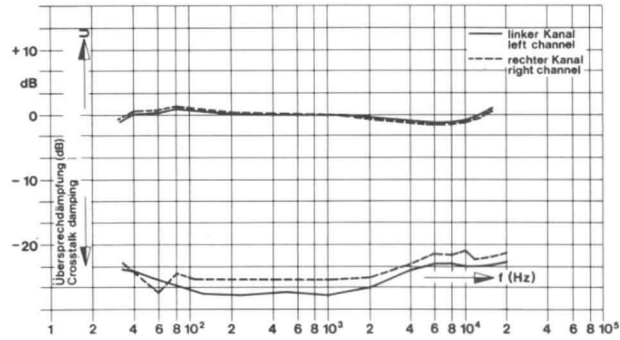

Abtastnadel

Stylus

Pointe de lecture

Spezial-Abtastnadel

Special stylus

Pointe de lecture spéciale

DN 330

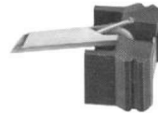

grau
grey
gris

M-Diamant = 15 μ
M-Diamond = 0.6 mil

212 804

88,-

G

DN 321

N-Diamant = 65 μ
N-Diamond = 2.7 mil

grün
green
vert

für **Normal**rillen-Schallplatten
Auflagekraft 3 p

for **normal** groove (78 rpm) records. Tracking weight 3 p

pour disques **normaux**. Force d'appui 3 p

202 440

61,-

G

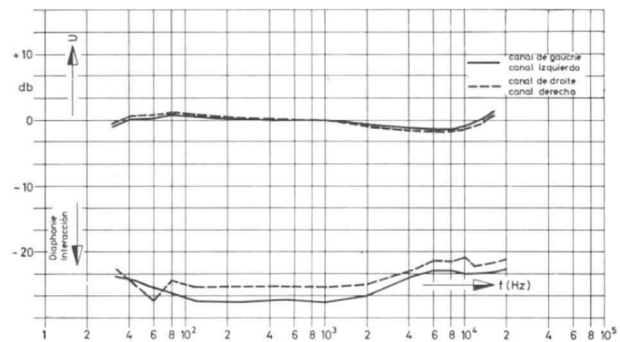

DN 330

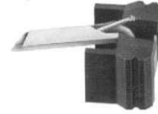

grau
grey
gris

M-Diamant = 15 μ
M-Diamond = 0.6 mil

212 804

88,-

G

DN 321

N-Diamant = 65 μ
N-Diamond = 2.7 mil

grün
green
vert

für **Normal**rillen-Schallplatten
Auflagekraft 3 p

for **normal** groove (78 rpm) records. Tracking weight 3 p

pour disques **normaux**. Force d'appui 3 p

202 440

61,-

G

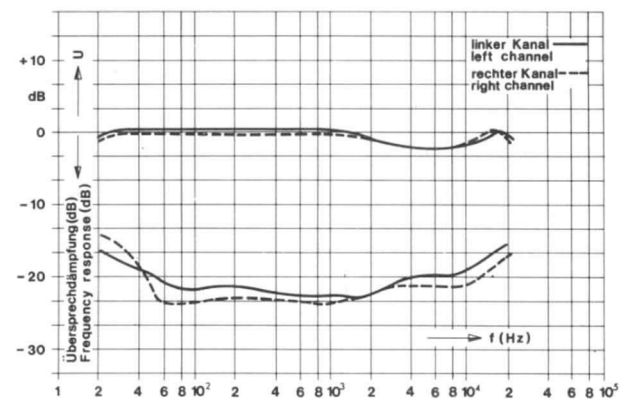

DN 325



beige

M-Diamant = 15 μ
M-Diamond = 0.6 mil

212 791

56,-

G

DN 321

N-Diamant = 65 μ
N-Diamond = 2.7 mil

grün
green
vert

für **Normal**rillen-Schallplatten
Auflagekraft 3 p

for **normal** groove (78 rpm) records. Tracking weight 3 p

pour disques **normaux**. Force d'appui 3 p





202 440

61,-

G

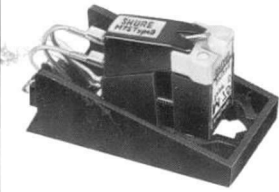
bei Einzelspiel und automatischem Plattenwechsel
 angle in either single play or changer mode
 en fonctionnement changeur de disques

Empfohlene Verbraucherpreise incl. MWST.

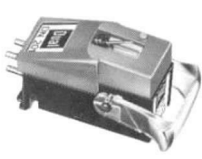
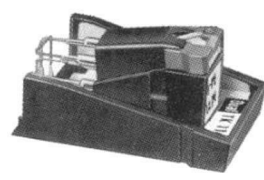
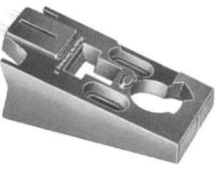
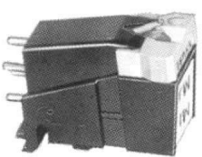
Geräte-Typ	Tonabnehmerkopf komplett	Kopf ohne System	Tonabnehmersystem mit Abtastnadel	Verwendungszweck Kenndaten
Model	Pick-up Head Complete	Head without Cartridge	Pick-up Cartridge with Stylus	Application Data
Appareil	Tête de lecture complète	Tête sans cellule	Cellule de pick-up avec pointe de lecture	Utilisation Données caractéristiques
1229 1219 1218 1216 1215 1214 / T 503 1212 1209	TK 120 	TK 14 	M 75 Typ D Shure  Stereo-Magnetsystem Magnetic stereo cartridge Cellule magnétique stéréo	Mikrorillen- und Stereo- Schallplatten Auflagekraft 2-3 p Micro- groove and stereo records Tracking weight 2-3 p Disques micro et stéréo . Force d'appui 2-3 p
	223 032	215 430	223 033	
	99,- E	7,- E	92,- E	
1229 1219 1218 1216 1215 1214 / T 503 1212 1209	TK 123 	TK 14 	DMS 200  Stereo-Magnetsystem Magnetic stereo cartridge Cellule magnétique stéréo	Mikrorillen- und Stereo- Schallplatten Auflagekraft 2-3 p Micro- groove and stereo records Tracking weight 2-3 p Disques micro et stéréo . Force d'appui 2-3 p
	228 659	215 430	228 656	
	97,- E	7,- E	90,- E	
1219 1218 1215 1212 1209	TK 122 	TK 14 	M 71 MB-D Shure  Stereo-Magnetsystem Magnetic stereo cartridge Cellule magnétique stéréo	Mikrorillen- und Stereo- Schallplatten Auflagekraft 2-3 p Micro- groove and stereo records Tracking weight 2-3 p Disques micro et stéréo . Force d'appui 2-3 p
	Ersatz: Replace: TK 123 Remplacement:	215 430 7,- E	Ersatz: Replace: DMS 200 Remplacement:	



Empfohlene Verbraucherpreise incl. MWSt.

Frequenzgang – Stereo- und Übersprechdämpfung, gemessen über Entzerrer-Vorverstärker TVV 46
 Meßplatte : DIN 45 541 (Schneidkennlinie 3180–318–75 μ s)
 Abspielgerät : Dual 1219

Frequency response, Stereo and crosstalk damping, measured with equalizer pre-amplifier TVV 46
 Test record : DIN 45 541 (recording curve 3180–318–75 μ s)
 Record player : Dual 1219

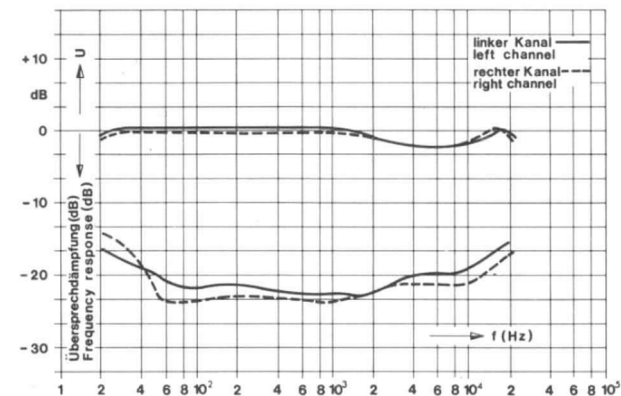
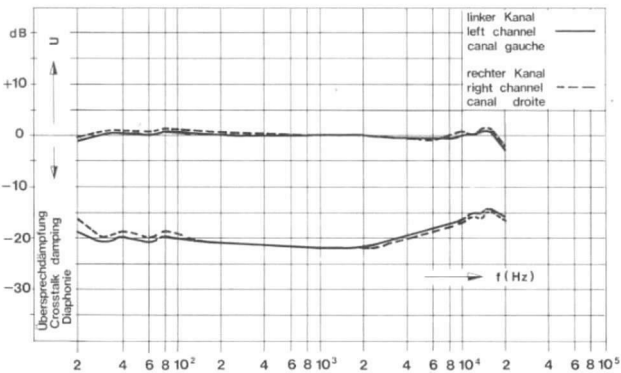
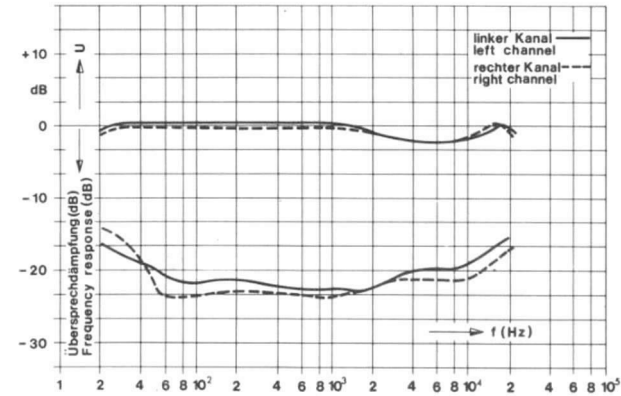
Courbe de fréquence, stéréo et taux de diaphonie, mesurés par l'intermédiaire du préamplificateur TVV 46
 Disque de contrôle DIN 45 541 (courbe de gravure 3180–318–75 μ s)
 Platine de reproduction : Dual 1219



Abtastnadel	Spezial-Abtastnadel
Stylus	Special stylus
Pointe de lecture	Pointe de lecture spéciale
<p>DN 325</p>  <p>beige</p> <p>M-Diamant = 15μ M-Diamond = 0.6 mil</p>	<p>DN 321</p> <p>N-Diamant = 65μ N-Diamond = 2.7 mil</p> <p>für Normalrillen-Schallplatten Auflagekraft 3 p</p> <p>for normal groove (78 rpm) records. Tracking weight 3 p</p> <p>grün green vert</p> <p>pour disques normaux. Force d'appui 3 p</p>
212 791	202 440
56,- G	61,- G
<p>DN 201</p>  <p>rot red rouge</p> <p>M-Diamant = 15μ M-Diamond = 0.6 mil</p>	<p>DN 202</p> <p>N-Diamant = 65μ N-Diamond = 2.7 mil</p> <p>für Normalrillen-Schallplatten Auflagekraft 3 p</p> <p>for normal groove (78 rpm) records. Tracking weight 3 p</p> <p>grün green vert</p> <p>pour disques normaux. Force d'appui 3 p</p>
228 657	228 658
42,- G	44,- G
<p>DN 325</p>  <p>beige</p> <p>M-Diamant = 15μ M-Diamond = 0.6 mil</p>	<p>DN 321</p> <p>N-Diamant = 65μ N-Diamond = 2.7 mil</p> <p>für Normalrillen-Schallplatten Auflagekraft 3 p</p> <p>for normal groove (78 rpm) records. Tracking weight 3 p</p> <p>grün green vert</p> <p>pour disques normaux. Force d'appui 3 p</p>
212 791	202 440
56,- G	61,- G

Empfohlene Verbraucherpreise incl. MWSt.

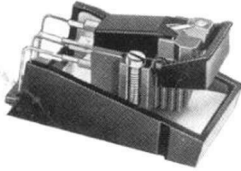
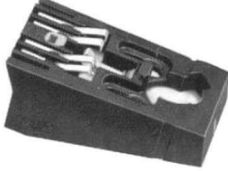
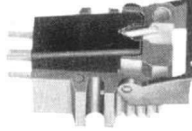
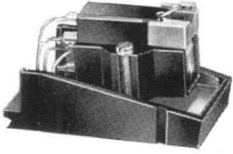
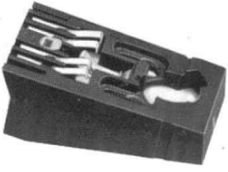
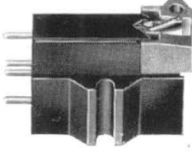
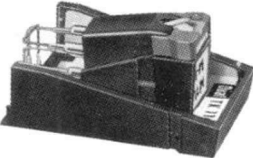
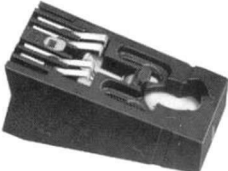
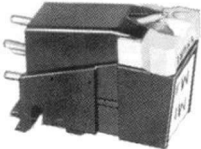
Geräte-Typ	Tonabnehmerkopf komplett	Kopf ohne System	Tonabnehmersystem mit Abtastnadel	Verwendungszweck Kenndaten
Model	Pick-up Head Complete	Head without Cartridge	Pick-up Cartridge with Stylus	Application Data
Appareil	Tête de lecture complète	Tête sans cellule	Cellule de pick-up avec pointe de lecture	Utilisation Données caractéristiques
1019 1016 1015 F 1009 SK / SK 2 / F	TK 113 	TK 12 	M 75 M-G Shure  Stereo-Magnetsystem Magnetic stereo cartridge Cellule magnétique stéréo	Mikrorillen- und Stereo-Schallplatten Auflagekraft 1-1,5 p Micro-groove and stereo records Tracking weight 1-1.5 p Disques micro et stéréo . Force d'appui 1-1,5 p
	Nicht mehr lieferbar No longer available Epuisé	213 836 7,- E	Ersatz: Replace: M 91 MG-D Remplacement:	
1019 1016 1015 F 1009 SK / SK 2 / F	TK 111 	TK 12 	M 44 M-G Shure  Stereo-Magnetsystem Magnetic stereo cartridge Cellule magnétique stéréo	Mikrorillen- und Stereo-Schallplatten Auflagekraft 1,5 p Micro-groove and stereo records Tracking weight 1.5 p Disques micro et stéréo . Force d'appui 1,5 p
	Nicht mehr lieferbar No longer available Epuisé	213 836 7,- E	Ersatz: Replace: DMS 200 Remplacement:	
1019 1016 1015 / F 1009 SK / SK 2 / F	TK 116 	TK 12 	M 71 MB-D Shure  Stereo-Magnetsystem Magnetic stereo cartridge Cellule magnétique stéréo	Mikrorillen- und Stereo-Schallplatten Auflagekraft 2-3 p Micro-groove and stereo records Tracking weight 2-3 p Disques micro et stéréo . Force d'appui 2-3 p
	213 517 99,- E	213 836 7,- E	Ersatz: Replace: DMS 200 Remplacement:	

Empfohlene Verbraucherpreise incl. MWSt.

Frequenzgang – Stereo- und Übersprechdämpfung, gemessen über Entzerrer-Vorverstärker TVV 46
 Meßplatte : DIN 45 541 (Schneidkennlinie 3180–318–75 μ s)
 Abspiegelgerät : Dual 1219

Frequenzy response, Stereo and crosstalk damping, measured with equalizer pre-amplifier TVV 46
 Test record : DIN 45 541 (recording curve 3180–318–75 μ s)
 Record player : Dual 1219

Courbe de fréquence, stéréo et taux de diaphonie, mesurés par l'intermédiaire du préamplificateur TVV 46
 Disque de contrôle DIN 45 541 (courbe de gravure 3180–318–75 μ s)
 Platine de reproduction : Dual 1219

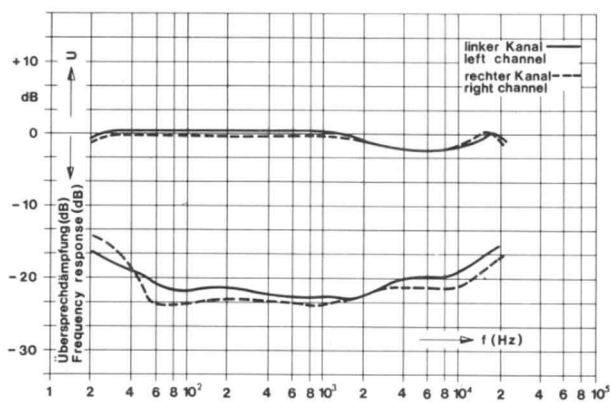
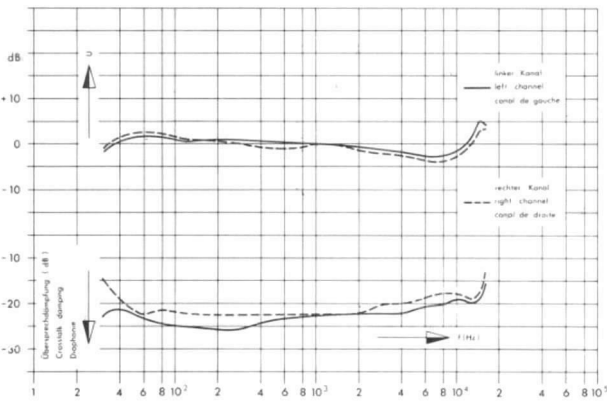
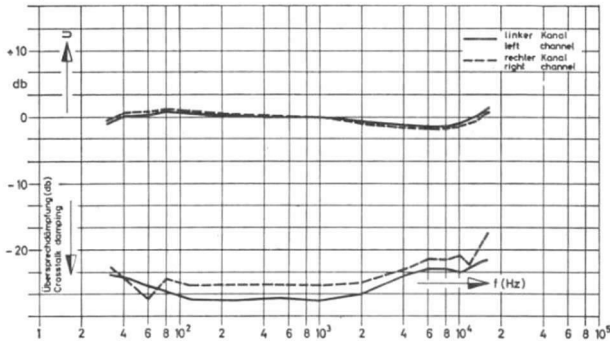

Abtastnadel

Stylus

Pointe de lecture

Spezial-Abtastnadel

Special stylus

Pointe de lecture spéciale

DN 320

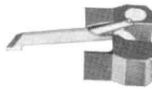

grau
grey
gris

M-Diamant = 15 μ
M-Diamond = 0.6 mil

207 570

78,-

G

DN 321

N-Diamant = 65 μ
N-Diamond = 2.7 mil

für **Normal**ritzen-Schallplatten
Auflagekraft 3 p

for **normal** groove (78 rpm) records. Tracking weight 3 p

grün
green
vert

pour disques **normaux**. Force d'appui 3 p

202 440

61,-

G

DN 305



grau
grey
gris

M-Diamant = 16 μ
M-Diamond = 0.7 mil

202 427

70,-

G

DN 306

N-Diamant = 65 μ
N-Diamond = 2.7 mil

für **Normal**ritzen-Schallplatten
Auflagekraft 3 p

for **normal** groove (78 rpm) records. Tracking weight 3 p

grün
green
vert

pour disques **normaux**. Force d'appui 3 p

202 429

59,-

G

DN 325

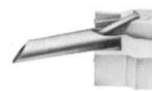

beige

M-Diamant = 15 μ
M-Diamond = 0.6 mil

212 791

56,-

G

DN 321

N-Diamant = 65 μ
N-Diamond = 2.7 mil

für **Normal**ritzen-Schallplatten
Auflagekraft 3 p

for **normal** groove (78 rpm) records. Tracking weight 3 p

grün
green
vert



pour disques **normaux**. Force d'appui 3 p

202 440

61,-

G

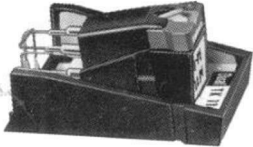
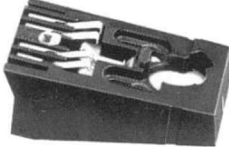
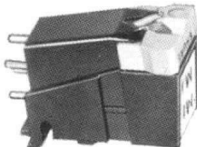
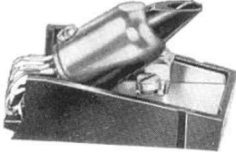
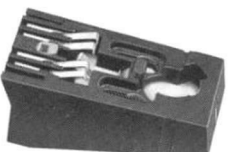
Empfohlene Verbraucherpreise incl. MWST.

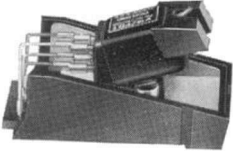
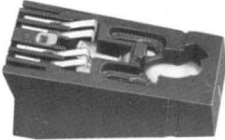
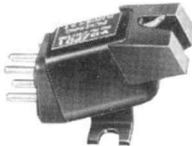
Geräte-Typ	Tonabnehmerkopf komplett	Kopf ohne System	Tonabnehmersystem mit Abtastnadel	Verwendungszweck Kenndaten
Model	Pick-up Head Complete	Head without Cartridge	Pick-up Cartridge with Stylus	Application Data
Appareil	Tête de lecture complète	Tête sans cellule	Cellule de pick-up avec pointe de lecture	Utilisation Données caractéristiques
1019 1016 1015/F 1009 SK / SK 2/F	TK 115 	TK 12 	M 73 M-G Shure  Stereo-Magnetsystem Magnetic stereo cartridge Cellule magnétique stéréo	Mikrorillen- und Stereo-Schallplatten Auflagekraft 1,25-1,75p Micro-groove and stereo records Tracking weight 1.25-1.75 p
	Nicht mehr lieferbar No longer available Epuisé	213 836 7,- E	Ersatz : Replace: M 91 MG-D Remplacement :	Disques micro et stéréo . Force d'appui 1,25-1,75 p
1019 1016 1015/F 1009 SK / SK 2/F	TK 121 	TK 12 	Sp 1 B & Q  Stereo-Magnetsystem Magnetic stereo cartridge Cellule magnétique stéréo	Mikrorillen- und Stereo-Schallplatten Auflagekraft 2-3 p Micro-groove and stereo records Tracking weight 2-3 p
	Ersatz : Replace: TK 116 Remplacement :	213 836 7,- E	Ersatz : Replace: DMS 200 Remplacement :	Disques micro et stéréo . Force d'appui 2-3 p
1019 1016 1015/F 1009 SK / SK 2/F	TK 132 	TK 12 	V 15/PD 1 Pickering  Stereo-Magnetsystem Magnetic stereo cartridge Cellule magnétique stéréo	Mikrorillen- und Stereo-Schallplatten Auflagekraft 1,5 p Micro-groove and stereo records Tracking weight 1.5 p
	Nicht mehr lieferbar No longer available Epuisé	213 836 7,- E	Ersatz : Replace: M 91 MG-D Remplacement :	Disques micro et stéréo . Force d'appui 1,5 p

Empfohlene Verbraucherpreise incl. MWSt.

Frequenzgang – Stereo- und Übersprechdämpfung, gemessen über Entzerrer-Vorverstärker TVV 46
 Meßplatte : DIN 45 541 (Schneidkennlinie 3180–318–75 μ s)
 Abspielgerät : Dual 1219

Frequency response, Stereo and crosstalk damping, measured with equalizer pre-amplifier TVV 46
 Test record : DIN 45 541 (recording curve 3180–318–75 μ s)
 Record player : Dual 1219

Courbe de fréquence, stéréo et taux de diaphonie, mesurés par l'intermédiaire du préamplificateur TVV 46
 Disque de contrôle DIN 45 541 (courbe de gravure 3180–318–75 μ s)
 Platine de reproduction : Dual 1219

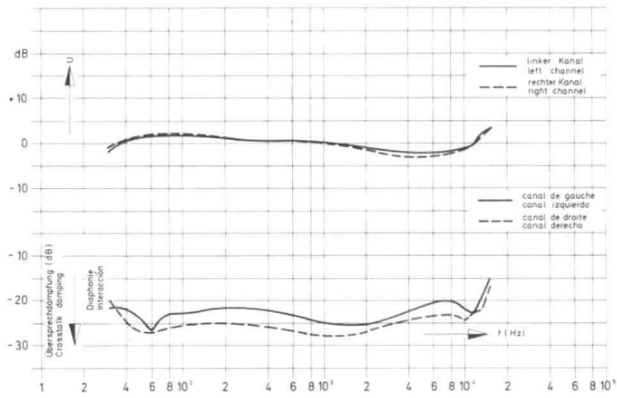

Abtastnadel

Stylus

Pointe de lecture

DN 323

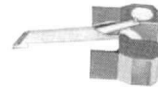

grau
grey
gris

M-Diamant = 15 μ
M-Diamond = 0.6 mil

Nicht mehr lieferbar
No longer available
Epuisé

Spezial-Abtastnadel

Special stylus

Pointe de lecture spéciale

DN 321

N-Diamant = 65 μ
N-Diamond = 2.7 mil

grün
green
vert

für **Normal**rillen-Schallplatten
Auflagekraft 3 p

for **normal** groove (78 rpm) records. Tracking weight 3 p

pour disques **normaux**. Force d'appui 3 p

202 440

61,-

G

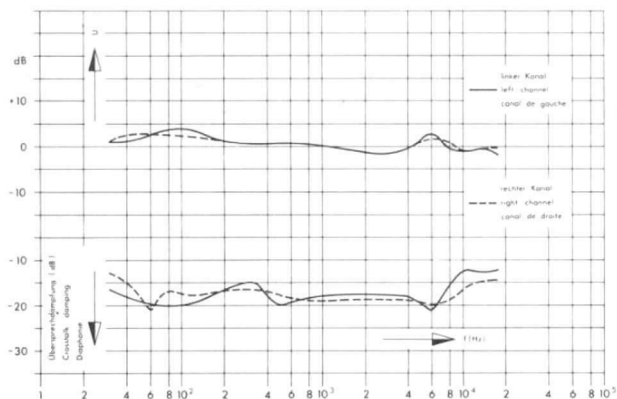

DN 301

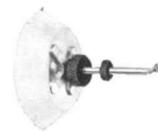

blau
blue
bleu

M-Diamant = 16 μ
M-Diamond = 0.7 mil

207 569

46,-

G

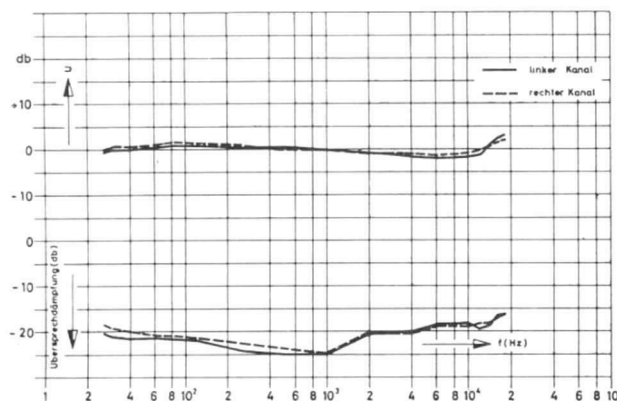

DN 315

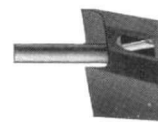

schwarz
black
noir

M-Diamant = 15 μ
M-Diamond = 0.6 mil

202 439

72,50

G

DN 314

N-Diamant = 65 μ
N-Diamond = 2.7 mil

blau
blue
bleu

für **Normal**rillen-Schallplatten
Auflagekraft 3 p

for **normal** groove (78 rpm) records. Tracking weight 3 p





pour disques **normaux**. Force d'appui 3 p

202 438

42,50

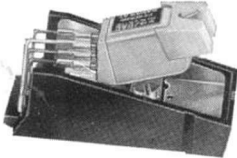
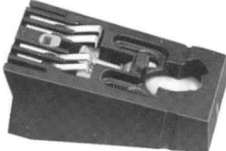
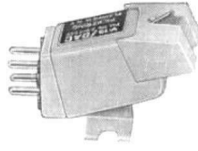
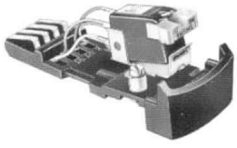
G

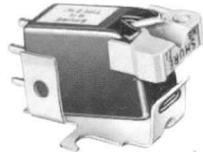
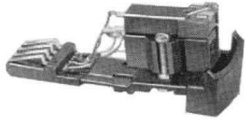
Empfohlene Verbraucherpreise incl. MWSt.

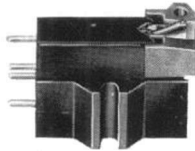
Geräte-Typ	Tonabnehmerkopf komplett	Kopf ohne System	Tonabnehmersystem mit Abstastnadel	Verwendungszweck Kenndaten
Model	Pick-up Head Complete	Head without Cartridge	Pick-up Cartridge with Stylus	Application Data
Appareil	Tête de lecture complète	Tête sans cellule	Cellule de pick-up avec pointe de lecture	Utilisation Données caractéristiques
1019 1016 1015 / F 1009 SK / SK 2 / F	TK 131 	TK 12 	V 15 / DAC Pickering  Stereo-Magnetsystem Magnetic stereo cartridge Cellule magnétique stéréo	Mikrorillen- und Stereo-Schallplatten Auflagekraft 2,5-3 p Micro-groove and stereo records Tracking weight 2.5-3 p Disques micro et stéréo . Force d'appui 2,5-3 p
	Ersatz: Replace: TK 116 Remplacement:	213 836 7,- E	Ersatz: Replace: DMS 200 Remplacement:	
1009	O 99 	O 12 b 	M 75 Typ D Shure 1/2"  Stereo-Magnetsystem Magnetic stereo cartridge Cellule magnétique stéréo	Mikrorillen- und Stereo-Schallplatten Auflagekraft 2-3 p Micro-groove and stereo records Tracking weight 2-3 p Disques micro et stéréo . Force d'appui 2-3 p
	Nicht mehr lieferbar No longer available Epuisé	207 793 5,50 E	223 644 92,- E	
1009	O 96 	O 12 b 	M 44 M-G Shure  Stereo-Magnetsystem Magnetic stereo cartridge Cellule magnétique stéréo	Mikrorillen- und Stereo-Schallplatten Auflagekraft 1,5 p Micro-groove and stereo records Tracking weight 1.5 p Disques micro et stéréo . Force d'appui 1,5 p
	Nicht mehr lieferbar No longer available Epuisé	207 793 5,50 E	Ersatz: Replace: M 75 Remplacement: Typ D 1/2"	

Empfohlene Verbraucherpreise incl. MWSt.

Frequenzgang – Stereo- und Übersprechdämpfung, gemessen über Entzerrer-Vorverstärker TVV 46
 Meßplatte : DIN 45 541 (Schneidkennlinie 3180–318–75 μ s)
 Abspielgerät : Dual 1219

Frequency response, Stereo and crosstalk damping, measured with equalizer pre-amplifier TVV 46
 Test record : DIN 45 541 (recording curve 3180–318–75 μ s)
 Record player : Dual 1219

Courbe de fréquence, stéréo et taux de diaphonie, mesurés par l'intermédiaire du préamplificateur TVV 46
 Disque de contrôle DIN 45 541 (courbe de gravure 3180–318–75 μ s)
 Platine de reproduction : Dual 1219

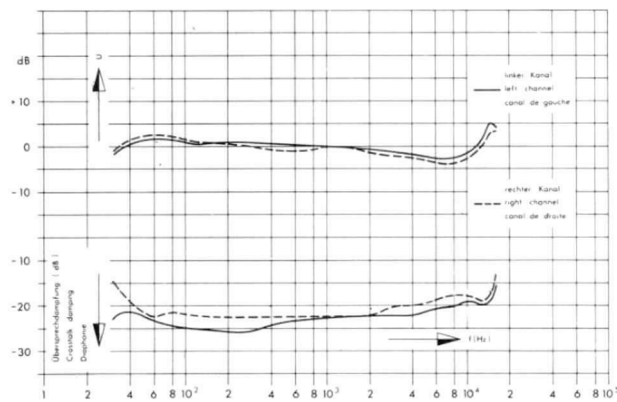
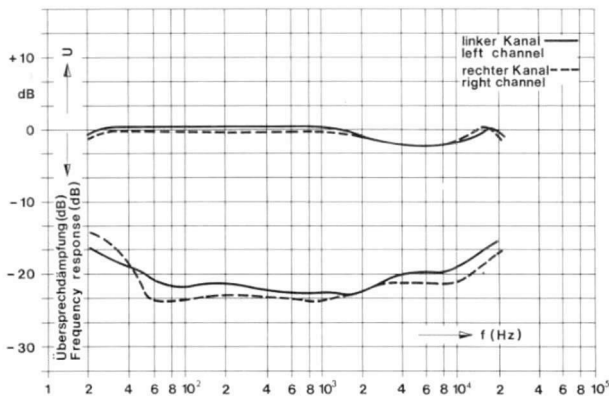
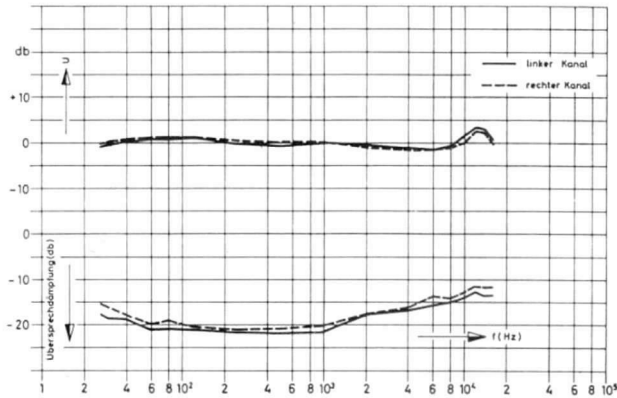

Abtastnadel

Stylus

Pointe de lecture

Spezial-Abtastnadel

Special stylus

Pointe de lecture spéciale

DN 311

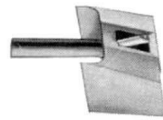

grau
grey
gris

M-Diamant = 17 μ
M-Diamond = 0.7 mil

202 437

46,50

G

DN 314

N-Diamant = 65 μ
N-Diamond = 2.7 mil

für **Normal**rillen-Schallplatten
Auflagekraft 3 p

for **normal** groove (78 rpm) records. Tracking weight 3 p

blau
blue
bleu

pour disques **normaux**. Force d'appui 3 p

202 438

42,50

G

DN 325



beige

M-Diamant = 15 μ
M-Diamond = 0.6 mil

212 791

56,-

G

DN 321

N-Diamant = 65 μ
N-Diamond = 2.7 mil

für **Normal**rillen-Schallplatten
Auflagekraft 3 p

for **normal** groove (78 rpm) records. Tracking weight 3 p

grün
green
vert

pour disques **normaux**. Force d'appui 3 p

202 440

61,-

G

DN 305

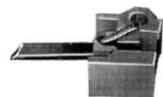

grau
grey
gris

M-Diamant = 16 μ
M-Diamond = 0.7 mil

202 427

70,-

G

DN 306

N-Diamant = 65 μ
N-Diamond = 2.7 mil

für **Normal**rillen-Schallplatten
Auflagekraft 3 p

for **normal** groove (78 rpm) records. Tracking weight 3 p

grün
green
vert



pour disques **normaux**. Force d'appui 3 p



202 429

59,-

G

Empfohlene Verbraucherpreise incl. MWSt.

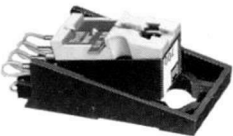
Geräte-Typ	Tonabnehmerkopf komplett	Kopf ohne System	Tonabnehmersystem mit Abtastnadel	Verwendungszweck Kenndaten
Model	Pick-up Head Complete	Head without Cartridge	Pick-up Cartridge with Stylus	Application Data
Appareil	Tête de lecture complète	Tête sans cellule	Cellule de pick-up avec pointe de lecture	Utilisation Données caractéristiques
1009	O 95 	O 12 b 	Sp 1 B & O  Stereo-Magnetsystem Magnetic stereo cartridge Cellule magnétique stéréo	Mikro riillen- und Stereo -Schallplatten Auflagekraft 2-3 p Micro - groove and stereo records Tracking weight 2-3 p Disques micro et stéréo . Force d'appui 2-3 p
	207 589	207 793	Ersatz : Replace : M 75 Remplacement : Typ D 1/2"	
	87,50 E	5,50 E		

HS 40 HS 41 HS 42 KA 20 KA 25	TK 201 	TK 14 	CDS 700  Stereo-Keramiksistem Ceramic stereo cartridge Cellule céramique stéréo	Mikro riillen- und Stereo -Schallplatten Auflagekraft 2,5 p Micro - groove and stereo records Tracking weight 2.5 p Disques micro et stéréo . Force d'appui 2,5 p
	220 398	215 430	219 772	
	60,- E	7,- E	53,- E	

Empfohlene Verbraucherpreise incl. MWSt.

Bei der Ausf. CDS 700 handelt es sich um ein sog. mittelempfindl. Keramiksistem.
The CDS 700 is an average sensitive ceramic cartridge.
La CDS 700 est une cellule céramique d'une moyenne sensibilité.

Frequenzgang – Stereo- und Übersprechdämpfung, gemessen über Entzerrer-Vorverstärker TVV 46
 Meßplatte : DIN 45 541 (Schneidkennlinie 3180–318–75 μ s)
 Abspielgerät : Dual 1219

Frequency response, Stereo and crosstalk damping, measured with equalizer pre-amplifier TVV 46
 Test record : DIN 45 541 (recording curve 3180–318–75 μ s)
 Record player : Dual 1219

Courbe de fréquence, stéréo et taux de diaphonie, mesurés par l'intermédiaire du préamplificateur TVV 46
 Disque de contrôle DIN 45 541 (courbe de gravure 3180–318–75 μ s)
 Platine de reproduction : Dual 1219

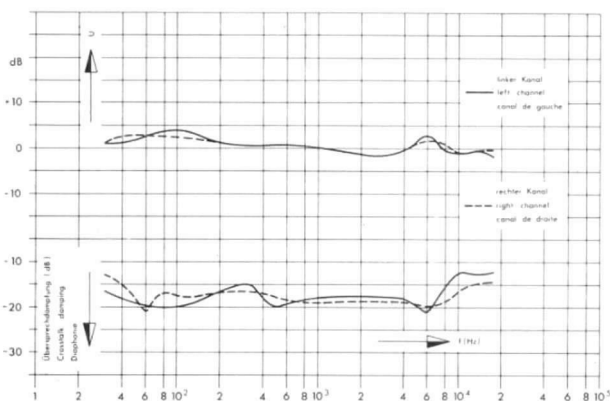

Abtastnadel

Spezial-Abtastnadel

Stylus

Special stylus

Pointe de lecture

Pointe de lecture spéciale

DN 301



blau
 blue
 bleu

M-Diamant = 16 μ
 M-Diamond = 0.7 mil

207 569

46,-

G

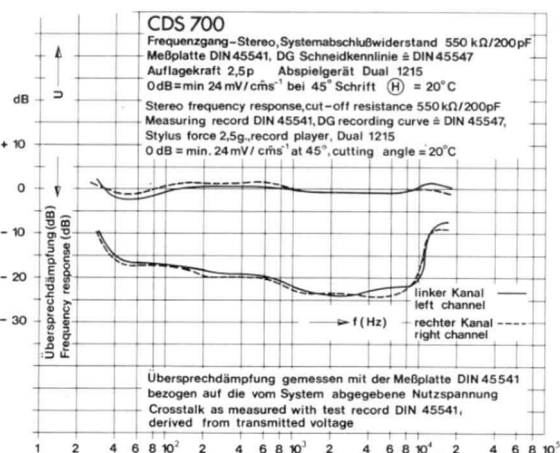

DN 70



M-Diamant = 15 μ
 M-Diamond = 0.6 mil

220 801

33,50

G

DN 7

M-Saphir = 15 μ
 M-Sapphire = 0.6 mil
 für Mikrorillen- und Stereo-Schallplatten
 for micro-groove and stereo records
 pour disques micro et stéréo

220 823

10,60

G

DN 78

N-Saphir = 60 μ
 N-Sapphire = 2.4 mil
 für Normalrillen-Schallplatten
 for normal groove (78 rpm) records
 pour disques normaux









220 822

10,60

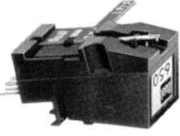
G

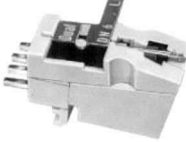
Die abgeg. Spannung p. Kanal betr. ca. 20 mV p. cm/sec.
 The given voltage per channel is about 20 mV per cm/sec.
 La tension réalisée par canal est environ 20 mV par cm/sec.

Empfohlene Verbraucherpreise incl. MWSt.

Geräte-Typ	Tonabnehmerkopf komplett	Kopf ohne System	Tonabnehmersystem mit Abtastnadel	Verwendungszweck Kenndaten
Model	Pick-up Head Complete	Head without Cartridge	Pick-up Cartridge with Stylus	Application Data
Appareil	Tête de lecture complète	Tête sans cellule	Cellule de pick-up avec pointe de lecture	Utilisation Données caractéristiques
1229 1219 1218 1216 1215 1214 1212 1211 1210 / A 1209	TK 181 	TK 14 	CDS 650 / 6  Stereo-Keramiksistem Ceramic stereo cartridge Cellule céramique stéréo	Mikrorillen- und Stereo-Schallplatten Auflagekraft 3,5-4,5 p Micro-groove and stereo records Tracking weight 3.5-4.5 p Disques micro et stéréo . Force d'appui 3,5-4,5 p
	218 855	215 430	218 865	
	36,50 E	7,- E	29,50 E	
1219 1218 1215 1214 1212 1210 1209	TK 171 	TK 14 	CDS 640 / 6  Stereo-Kristallsystem Crystal stereo cartridge Cellule cristal stéréo	Mikrorillen- und Stereo-Schallplatten Auflagekraft 3,5-4,5 p Micro-groove and stereo records Tracking weight 3.5-4.5 p Disques micro et stéréo . Force d'appui 3,5-4,5 p
	Ersatz: Replace: TK 181 Remplacement:	215 430	Ersatz: Replace: CDS 650 / 6 Remplacement:	
		7,- E		
1219 1218 1215 1214 1212 1210 1209	TK 155 	TK 14 	CDS 630 / 5  Stereo-Kristallsystem Crystal stereo cartridge Cellule cristal stéréo	Normal-, Mikrorillen- und Stereo-Schallplatten Auflagekraft 3,5-4,5 p Normal (78 rpm)-, Micro-groove and stereo records Tracking weight 3.5-4.5 p Disques normaux, micro et stéréo Force d'appui 3,5-4,5 p
	215 414	215 430	Ersatz: Replace: CDS 650 / 6 Remplacement:	
	33,50 E	7,- E		







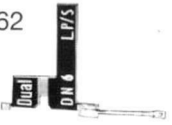

Empfohlene Verbraucherpreise incl. MWSt.

Abtastnadel

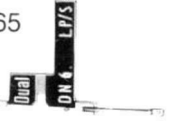

Stylus

Spezial-Abtastnadeln · Special styli · Pointes de lecture spéciales

Pointe de lecture

<p>DN 6</p>  <p>M-Saphir = 15μ M-Saphir = 15μ M-Sapphire = 0.6 mil M-Sapphire = 0.6 mil</p>	<p>DN 62</p>  <p>M-Saphir = 15μ M-Saphir = 23μ M-Sapphire = 0.6 mil M-Sapphire = 1 mil</p> <p>für Mikrorillen- und Stereo-Schallplatten</p>	<p>DN 65</p>  <p>M-Diamant = 15μ M-Diamond = 0.6 mil</p> <p>for micro-groove and stereo records</p>	<p>DN 64</p>  <p>M-Diamant = 15μ M-Saphir = 23μ M-Diamond = 0.6 mil M-Sapphire = 1 mil</p> <p>pour disques micro et stéréo</p>	<p>DN 63</p> <p>M-Saphir = 15μ N-Saphir = 60μ M-Sapphire = 0.6 mil N-Sapphire = 2.4 mil</p> <p>für Normal-, Mikrorillen- und Stereo-Schallplatten for normal (78 rpm)-, micro-groove and stereo records pour disques normaux, micro et stéréo</p>
<p>211 972</p> <p>9,80 G</p>	<p>211 973</p> <p>9,80 G</p>	<p>212 035</p> <p>31,20 G</p>	<p>211 974</p> <p>32,50 G</p>	<p>212 034</p> <p>9,80 G</p>
<p>DN 6</p>  <p>M-Saphir = 15μ M-Saphir = 15μ M-Sapphire = 0.6 mil M-Sapphire = 0.6 mil</p>	<p>DN 62</p>  <p>M-Saphir = 15μ M-Saphir = 23μ M-Sapphire = 0.6 mil M-Sapphire = 1 mil</p> <p>für Mikrorillen- und Stereo-Schallplatten</p>	<p>DN 65</p>  <p>M-Diamant = 15μ M-Diamond = 0.6 mil</p> <p>for micro-groove and stereo records</p>	<p>DN 64</p>  <p>M-Diamant = 15μ M-Saphir = 23μ M-Diamond = 0.6 mil M-Sapphire = 1 mil</p> <p>pour disques micro et stéréo</p>	<p>DN 63</p> <p>M-Saphir = 15μ N-Saphir = 60μ M-Sapphire = 0.6 mil N-Sapphire = 2.4 mil</p> <p>für Normal-, Mikrorillen- und Stereo-Schallplatten for normal (78 rpm)-, micro-groove and stereo records pour disques normaux, micro et stéréo</p>
<p>211 972</p> <p>9,80 G</p>	<p>211 973</p> <p>9,80 G</p>	<p>212 035</p> <p>31,20 G</p>	<p>211 974</p> <p>32,50 G</p>	<p>212 034</p> <p>9,80 G</p>
<p>DN 5</p>  <p>M-Saphir = 15μ N-Saphir = 60μ M-Sapphire = 0.6 mil N-Sapphire = 2.4 mil</p>	<p>DN 55</p>  <p>M-Saphir = 15μ M-Saphir = 15μ M-Sapphire = 0.6 mil M-Sapphire = 0.6 mil</p> <p>für Mikrorillen- und Stereo-Schallplatten</p>	<p>DN 56</p>  <p>M-Saphir = 15μ M-Diamant = 15μ M-Sapphire = 0.6 mil M-Diamond = 0.6 mil</p> <p>for micro-groove and stereo records</p> <p>pour disques micro et stéréo</p>		
<p>202 529</p> <p>9,20 G</p>	<p>217 965</p> <p>9,20 G</p>	<p>217 966</p> <p>31,20 G</p>		

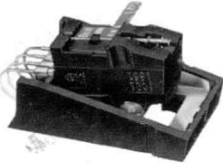
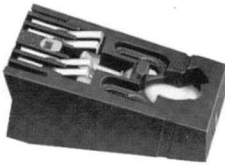
Empfohlene Verbraucherpreise incl. MWSt.

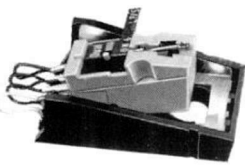
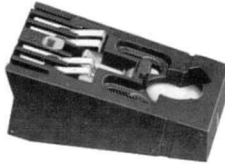
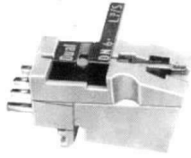
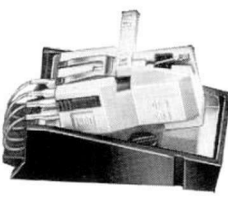
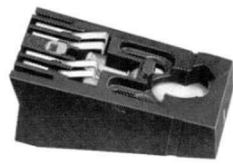
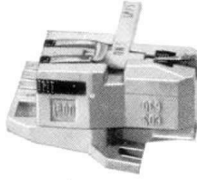
Geräte-Typ	Tonabnehmerkopf komplett	Kopf ohne System	Tonabnehmersystem mit Abtastnadel	Verwendungszweck Kenndaten
Model	Pick-up Head Complete	Head without Cartridge	Pick-up Cartridge with Stylus	Application Data
Appareil	Tête de lecture complète	Tête sans cellule	Cellule de pick-up avec pointe de lecture	Utilisation Données caractéristiques
1019 1016 1015 / F 1010 A / S / F 1009 SK / SK 2 / F	TK 168 	TK 12 	CDS 651 / 6  Stereo-Keramiksistem Ceramic stereo cartridge Cellule céramique stéréo	Mikrorillen- und Stereo-Schallplatten Auflagekraft 3,5-4,5 p Micro-groove and stereo records Tracking weight 3.5-4.5 p Disques micro et stéréo . Force d'appui 3,5-4,5 p
	219 044	213 836	218 885	
	36,50 E	7,- E	29,50 E	
1019 1016 1015 / F 1010 A / S / F 1009 SK / SK 2 / F	TK 161 	TK 12 	CDS 640 / 6  Stereo-Kristallsystem Crystal stereo cartridge Cellule cristal stéréo	Mikrorillen- und Stereo-Schallplatten Auflagekraft 3,5-4,5 p Micro-groove and stereo records Tracking weight 3.5-4.5 p Disques micro et stéréo . Force d'appui 3,5-4,5 p
	Ersatz: Replace: TK 168 Remplacement:	213 836 7,- E	Ersatz: Replace: CDS 651 / 6 Remplacement:	
1019 1016 1015 / F 1010 A / S / F 1009 SK / SK 2 / F	TK 151 	TK 12 	CDS 630 / 5  Stereo-Kristallsystem Crystal stereo cartridge Cellule cristal stéréo	Normal-, Mikrorillen- und Stereo-Schallplatten Auflagekraft 3,5-4,5 p Normal (78 rpm)-, micro-groove and stereo records Tracking weight 3.5-4.5 p Disques normaux, micro et stéréo Force d'appui 3,5-4,5 p
	202 590	213 836	Ersatz: Replace: CDS 651 / 6 Remplacement:	
	33,50 E	7,- E		











Empfohlene Verbraucherpreise incl. MWSt.

Abtastnadel

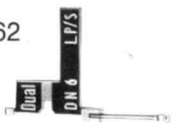
Stylus

Spezial-Abtastnadeln · Special styli · Pointes de lecture spéciales

Pointe de lecture

<p>DN 6</p>  <p>M-Saphir = 15μ M-Saphir = 15μ M-Sapphire = 0.6 mil M-Sapphire = 0.6 mil</p>	<p>DN 62</p>  <p>M-Saphir = 15μ M-Saphir = 23μ M-Sapphire = 0.6 mil M-Sapphire = 1 mil</p> <p>für Mikrorillen- und Stereo-Schallplatten</p>	<p>DN 65</p>  <p>M-Diamant = 15μ M-Diamond = 0.6 mil</p> <p>for micro-groove and stereo records</p>	<p>DN 64</p>  <p>M-Diamant = 15μ M-Saphir = 23μ M-Diamond = 0.6 mil M-Sapphire = 1 mil</p> <p>pour disques micro et stéréo</p>	<p>DN 63</p> <p>M-Saphir = 15μ N-Saphir = 60μ M-Sapphire = 0.6 mil N-Sapphire = 2.4 mil</p> <p>für Normal-, Mikrorillen- und Stereo-Schallplatten für normal (78 rpm)-, micro-groove and stereo records pour disques normaux, micro et stéréo</p>
<p>211 972</p>	<p>211 973</p>	<p>212 035</p>	<p>211 974</p>	<p>212 034</p>
<p>9,80 G</p>	<p>9,80 G</p>	<p>31,20 G</p>	<p>32,50 G</p>	<p>9,80 G</p>
<p>DN 6</p>  <p>M-Saphir = 15μ M-Saphir = 15μ M-Sapphire = 0.6 mil M-Sapphire = 0.6 mil</p>	<p>DN 62</p>  <p>M-Saphir = 15μ M-Saphir = 23μ M-Sapphire = 0.6 mil M-Sapphire = 1 mil</p> <p>für Mikrorillen- und Stereo-Schallplatten</p>	<p>DN 65</p>  <p>M-Diamant = 15μ M-Diamond = 0.6 mil</p> <p>for micro-groove and stereo records</p>	<p>DN 64</p>  <p>M-Diamant = 15μ M-Saphir = 23μ M-Diamond = 0.6 mil M-Sapphire = 1 mil</p> <p>pour disques micro et stéréo</p>	<p>DN 63</p> <p>M-Saphir = 15μ N-Saphir = 60μ M-Sapphire = 0.6 mil N-Sapphire = 2.4 mil</p> <p>für Normal-, Mikrorillen- und Stereo-Schallplatten for normal (78 rpm)-, micro-groove and stereo records pour disques normaux, micro et stéréo</p>
<p>211 972</p>	<p>211 973</p>	<p>212 035</p>	<p>211 974</p>	<p>212 034</p>
<p>9,80 G</p>	<p>9,80 G</p>	<p>31,20 G</p>	<p>32,50 G</p>	<p>9,80 G</p>
<p>DN 5</p>  <p>M-Saphir = 15μ N-Saphir = 60μ M-Sapphire = 0.6 mil N-Sapphire = 2.4 mil</p>	<p>DN 55</p>  <p>M-Saphir = 15μ M-Saphir = 15μ M-Sapphire = 0.6 mil M-Sapphire = 0.6 mil</p> <p>für Mikrorillen- und Stereo-Schallplatten</p>	<p>DN 56</p>  <p>M-Saphir = 15μ M-Diamant = 15μ M-Sapphire = 0.6 mil M-Diamond = 0.6 mil</p> <p>for micro-groove and stereo records</p>	<p>pour disques micro et stéréo</p>	
<p>202 529</p>	<p>217 965</p>	<p>217 966</p>		
<p>9,20 G</p>	<p>9,20 G</p>	<p>29,20 G</p>		

Empfohlene Verbraucherpreise incl. MWST.

Geräte-Typ	Tonabnehmerkopf komplett	Kopf ohne System	Tonabnehmersystem mit Abtastnadel	Verwendungszweck Kenndaten
Model	Pick-up Head Complete	Head without Cartridge	Pick-up Cartridge with Stylus	Application Data
Appareil	Tête de lecture complète	Tête sans cellule	Cellule de pick-up avec pointe de lecture	Utilisation Données caractéristiques
1011 1010 1009 1008 A 1007 A	O 250 	O 12 b 	CDS 651 / 6  Stereo-Keramiksistem Ceramic stereo cartridge Cellule céramique stéréo	Mikrorillen- und Stereo-Schallplatten Auflagekraft 3,5-4,5 p Micro-groove and stereo records Tracking weight 3.5-4.5 p Disques micro et stéréo . Force d'appui 3,5-4,5 p
	219 042	207 793	218 885	
	35,— E	5,50 E	29,50 E	
1011 1010 1009 1008 A 1007 A	O 240 	O 12 b 	CDS 642 / 6  Stereo-Kristallsystem Crystal stereo cartridge Cellule cristal stéréo	Mikrorillen- und Stereo-Schallplatten Auflagekraft 3,5-4,5 p Micro-groove and stereo records Tracking weight 3.5-4.5 p Disques micro et stéréo . Force d'appui 3,5-4,5 p
	Ersatz: Replace: O 250 Remplacement:	207 793	Ersatz: Replace: CDS 651 / 6 Remplacement:	
		5,50 E		
1011 1010 1009 1008 A 1007 A	O 212 	O 12 b 	CDS 630 / 5  Stereo-Kristallsystem Crystal stereo cartridge Cellule cristal stéréo	Normal-, Mikrorillen- und Stereo-Schallplatten Auflagekraft 3,5-4,5 p Normal (78 rpm)-, micro-groove and stereo records Tracking weight 3.5-4.5 p Disques normaux, micro et stéréo Force d'appui 3,5-4,5 p
	Ersatz: Replace: O 250 Remplacement:	207 793	Ersatz: Replace: CDS 651 / 6 Remplacement:	
		5,50 E		









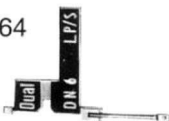

Empfohlene Verbraucherpreise incl. MWSt.

Abtastnadel

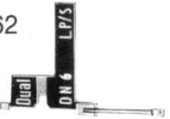



Stylus

Spezial-Abtastnadeln · Special styli · Pointes de lecture spéciales

Pointe de lecture

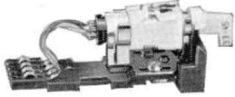
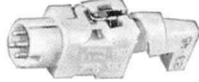
<p>DN 6</p>  <p>M-Saphir = 15μ M-Saphir = 15μ M-Sapphire = 0.6 mil M-Sapphire = 0.6 mil</p>	<p>DN 62</p>  <p>M-Saphir = 15μ M-Saphir = 23μ M-Sapphire = 0.6 mil M-Sapphire = 1 mil</p>	<p>DN 65</p>  <p>M-Diamant = 15μ M-Diamond = 0.6 mil</p>	<p>DN 64</p>  <p>M-Diamant = 15μ M-Saphir = 23μ M-Diamond = 0.6 mil M-Sapphire = 1 mil</p>	<p>DN 63</p> <p>M-Saphir = 15μ N-Saphir = 60μ M-Sapphire = 0.6 mil N-Sapphire = 2.4 mil</p> <p>für Normal-, Mikrorillen- und Stereo-Schallplatten for normal (78 rpm)-, micro- groove and stereo records pour disques normaux, micro et stéréo</p>
<p>211 972</p> <p>9,80 G</p>	<p>211 973</p> <p>9,80 G</p>	<p>212 035</p> <p>31,20 G</p>	<p>211 974</p> <p>32,50 G</p>	<p>212 034</p> <p>9,80 G</p>
<p>DN 6</p>  <p>M-Saphir = 15μ M-Saphir = 15μ M-Sapphire = 0.6 mil M-Sapphire = 0.6 mil</p>	<p>DN 62</p>  <p>M-Saphir = 15μ M-Saphir = 23μ M-Sapphire = 0.6 mil M-Sapphire = 1 mil</p>	<p>DN 65</p>  <p>M-Diamant = 15μ M-Diamond = 0.6 mil</p>	<p>DN 64</p>  <p>M-Diamant = 15μ M-Saphir = 23μ M-Diamond = 0.6 mil M-Sapphire = 1 mil</p>	<p>DN 63</p> <p>M-Saphir = 15μ N-Saphir = 60μ M-Sapphire = 0.6 mil N-Sapphire = 2.4 mil</p> <p>für Normal-, Mikrorillen- und Stereo-Schallplatten for normal (78 rpm)-, micro- groove and stereo records pour disques normaux, micro et stéréo</p>
<p>211 972</p> <p>9,80 G</p>	<p>211 973</p> <p>9,80 G</p>	<p>212 035</p> <p>31,20 G</p>	<p>211 974</p> <p>32,50 G</p>	<p>212 034</p> <p>9,80 G</p>
<p>DN 5</p>  <p>M-Saphir = 15μ N-Saphir = 60μ M-Sapphire = 0.6 mil N-Sapphire = 2.4 mil</p>	<p>DN 55</p>  <p>M-Saphir = 15μ M-Saphir = 15μ M-Sapphire = 0.6 mil M-Sapphire = 0.6 mil</p>	<p>DN 56</p>  <p>M-Saphir = 15μ M-Diamant = 15μ M-Sapphire = 0.6 mil M-Diamond = 0.6 mil</p>	<p>für Mikrorillen- und Stereo-Schallplatten for micro-groove and stereo records pour disques micro et stéréo</p>	
<p>202 529</p> <p>9,20 G</p>	<p>217 965</p> <p>9,20 G</p>	<p>217 966</p> <p>31,20 G</p>		

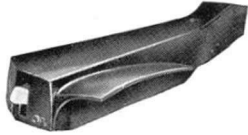
Empfohlene Verbraucherpreise incl. MWSt.

Geräte-Typ	Tonabnehmerkopf komplett	Kopf ohne System	Tonabnehmersystem mit Abtastnadel	Verwendungszweck Kenndaten
Model	Pick-up Head Complete	Head without Cartridge	Pick-up Cartridge with Stylus	Application Data
Appareil	Tête de lecture complète	Tête sans cellule	Cellule de pick-up avec pointe de lecture	Utilisation Données caractéristiques
1011 1010 1009 1008 A 1007 A	O 1 b 	O 11 b	CDS 620 / 4 / 45  Stereo-Kristallsystem Crystal stereo cartridge Cellule cristal stéréo	Normal-, Mikro- und Stereo- Schallplatten Auflagekraft 5,5-6,5 p Normal (78 rpm)-, micro- groove and stereo records Tracking weight 5.5-6.5 p Disques normaux , micro et stéréo Force d'appui 5,5-6,5 p
	Ersatz: Replace: O 250 Remplacement:		Nicht mehr lieferbar No longer available Epuisé	
1006 / A	LK 33 		CDS 420 / 4  Stereo-Kristallsystem Crystal stereo cartridge Cellule cristal stéréo	Mikro- und Stereo- Schallplatten Auflagekraft 5,5 p Micro- groove and stereo records Tracking weight 5.5 p Disques micro et stéréo . Force d'appui 5,5 p
	Nicht mehr lieferbar No longer available Epuisé		Nicht mehr lieferbar No longer available Epuisé	
1008 1007		Tonabnehmerkopf ist vom Gerät nicht abnehmbar The pick-up head is not removable from the unit La tête de lecture ne peut pas être séparée de l'appareil	CDS 520 / 3  Stereo-Kristallsystem Crystal stereo cartridge Cellule cristal stéréo	Normal-, Mikro- und Stereo- Schallplatten Auflagekraft 5,5 p Normal (78 rpm)-, micro- groove and stereo records Tracking weight 5.5 p Disques normaux , micro et stéréo Force d'appui 5,5 p
			207 562 weiß/white/blanc	
			28,—	E









Empfohlene Verbraucherpreise incl. MWSt.

Abtastnadel







Stylus

Spezial-Abtastnadeln · Special styli · Pointes de lecture spéciales

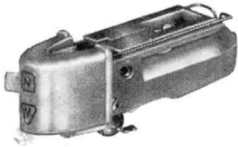
Pointe de lecture

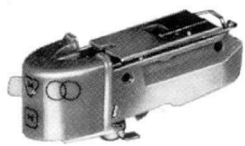
<p>DN 4</p>  <p>M-Saphir = 15μ M-Sapphire = 0.6 mil</p>	<p>DN 43</p> <p>M-Diamant = 15μ M-Diamond = 0.6 mil</p>  <p>für Mikrorillen- und Stereo-Schallplatten for micro-groove and stereo records pour disques micro et stéréo</p>			<p>DN 45</p> <p>N-Saphir = 60μ N-Sapphire = 2.4 mil</p> <p>für Normalrillen-Schallplatten for normal-groove (78 rpm) records pour disques normaux</p>
207 553 grün green vert	207 555 grün/gold green/gold vert/or			207 554 grün/rot green/red vert/rouge
6,20 G	29,20 G			6,20 G
<p>DN 4</p>  <p>M-Saphir = 15μ M-Sapphire = 0.6 mil</p>	<p>DN 43</p> <p>M-Diamant = 15μ M-Diamond = 0.6 mil</p>  <p>für Mikrorillen- und Stereo-Schallplatten for micro-groove and stereo records pour disques micro et stéréo</p>			<p>DN 45</p> <p>N-Saphir = 60μ N-Sapphire = 2.4 mil</p> <p>für Normalrillen-Schallplatten for normal-groove (78 rpm) records pour disques normaux</p>
207 553 grün green vert	207 555 grün/gold green/gold vert/or			207 554 grün/rot green/red vert/rouge
6,20 G	29,20 G			6,20 G
<p>DN 3</p>  <p>N M</p> <p>M-Saphir = 15μ N-Saphir = 60μ M-Sapphire = 0.6 mil N-Sapphire = 2.4 mil</p>	<p>DN 23</p>  <p>M-Diamant = 15μ M-Diamond = 0.6 mil</p> <p>für Mikrorillen- und Stereo-Schallplatten</p>	<p>DN 26</p>  <p>M-Saphir = 15μ M-Sapphire = 0.6 mil</p> <p>for micro-groove and stereo records</p>	<p>DN 32</p>  <p>M 2 M 1</p> <p>M 1 - Saphir = 15μ M 2 - Saphir = 23μ M 1 - Sapphire = 0.6 mil M 2 - Sapphire = 1 mil</p> <p>pour disques micro et stéréo</p>	<p>DN 34</p> <p>M-Diamant = 15μ N-Saphir = 60μ M-Diamond = 0.6 mil N-Sapphire = 2.4 mil</p> <p>für Normal-, Mikrorillen- und Stereo-Schallplatten for normal (78 rpm)-, micro-groove and stereo records pour disques normaux, micro et stéréo</p>
207 542 braun brown brun	207 513 gold gold or	207 512 rot red rouge	207 540 rot red rouge	207 541 silber/braun silver/brown argent/brun
7,60 G	29,20 G	6,20 G	7,60 G	31,20 G

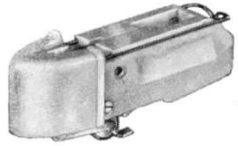
Empfohlene Verbraucherpreise incl. MWSt.

Geräte-Typ	Tonabnehmerkopf komplett	Kopf ohne System	Tonabnehmersystem mit Abtastnadel	Verwendungszweck Kenndaten
Model	Pick-up Head Complete	Head without Cartridge	Pick-up Cartridge with Stylus	Application Data
Appareil	Tête de lecture complète	Tête sans cellule	Cellule de pick-up avec pointe de lecture	Utilisation Données caractéristiques
1004 S / D	K		CDS 3	Normal- und Mikrorillen- Schallplatten Auflagekraft 9 p
				Normal (78 rpm)-, and micro-groove records Tracking weight 9 p
	207 530		Kristallsystem Crystal cartridge Cellule cristal	Disques normaux et micro . Force d'appui 9 p
	207 530		207 515 weiß/white/blanc	
	28,— E		20,— E	
1004 S / D	KS 2		CDS 320 / 3	Normal-, Mikrorillen- und Stereo- Schallplatten Auflagekraft 5,5 p
				Normal (78 rpm)-, micro-groove and stereo records Tracking weight 5.5 p
	207 543		Stereo-Kristallsystem Crystal stereo cartridge Cellule cristal stéréo	Disques normaux, micro et stéréo Force d'appui 5,5 p
	207 543	Nicht mehr lieferbar No longer available Epuisé	207 545 rot/red/rouge	
	33,50 E		27,— E	
1005 1003	J		CDS 3	Normal- und Mikrorillen- Schallplatten Auflagekraft 9 p
				Normal (78 rpm)-, and micro-groove records Tracking weight 9 p
	207 523		Kristallsystem Crystal cartridge Cellule cristal	Disques normaux et micro . Force d'appui 9 p
	207 523		207 515 weiß/white/blanc	
	28,— E		20,— E	













Empfohlene Verbraucherpreise incl. MWSt.

Abtastnadel





Stylus

Spezial-Abtastnadeln · Special styli · Pointes de lecture spéciales

Pointe de lecture

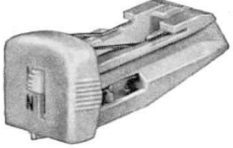
<p>DN 2</p>  <p>M N</p> <p>M-Saphir = 23μ N-Saphir = 60μ M-Sapphire = 1 mil N-Sapphire = 2.4 mil</p>	<p>DN 23</p>  <p>M-Diamant = 15μ M-Diamond = 0.6 mil</p>	<p>DN 26</p>  <p>M-Saphir = 15μ M-Sapphire = 0.6 mil</p>	<p>DN 22</p>  <p>M 1 - Saphir = 23μ M 2 - Saphir = 23μ M 1 - Sapphire = 1 mil M 2 - Sapphire = 1 mil</p>	<p>DN 24</p> <p>M-Diamant = 15μ N-Saphir = 60μ M-Diamond = 0.6 mil N-Sapphire = 2.4 mil</p> <p>für Normal-, Mikro- und Stereo-Schallplatten for normal (78 rpm)-, micro- groove and stereo records pour disques normaux, micro et stéréo</p>
<p>207 514</p> <p>blau blue bleu</p>	<p>207 513</p> <p>gold gold or</p>	<p>207 512</p> <p>rot red rouge</p>	<p>207 518</p> <p>rot red rouge</p>	<p>207 517</p> <p>silber silver argent</p>
<p>7,60</p> <p>G</p>	<p>29,20</p> <p>G</p>	<p>6,20</p> <p>G</p>	<p>7,80</p> <p>G</p>	<p>31,20</p> <p>G</p>
<p>DN 3</p>  <p>N M</p> <p>M-Saphir = 15μ N-Saphir = 60μ M-Sapphire = 0.6 mil N-Sapphire = 2.4 mil</p>	<p>DN 23</p>  <p>M-Diamant = 15μ M-Diamond = 0.6 mil</p>	<p>DN 26</p>  <p>M-Saphir = 15μ M-Sapphire = 0.6 mil</p>	<p>DN 32</p>  <p>M 2 M 1</p> <p>M 1 - Saphir = 15μ M 2 - Saphir = 23μ M 1 - Sapphire = 0.6 mil M 2 - Sapphire = 1 mil</p>	<p>DN 34</p> <p>M-Diamant = 15μ N-Saphir = 60μ M-Diamond = 0.6 mil N-Sapphire = 2.4 mil</p> <p>für Normal-, Mikro- und Stereo-Schallplatten for normal (78 rpm)-, micro- groove and stereo records pour disques normaux, micro et stéréo</p>
<p>207 542</p> <p>braun brown brun</p>	<p>207 513</p> <p>gold gold or</p>	<p>207 512</p> <p>rot red rouge</p>	<p>207 540</p> <p>rot red rouge</p>	<p>207 541</p> <p>silber/braun silver/brown argent/brun</p>
<p>7,60</p> <p>G</p>	<p>29,20</p> <p>G</p>	<p>6,20</p> <p>G</p>	<p>7,60</p> <p>G</p>	<p>31,20</p> <p>G</p>
<p>DN 2</p>  <p>M N</p> <p>M-Saphir = 23μ N-Saphir = 60μ M-Sapphire = 1 mil N-Sapphire = 2.4 mil</p>	<p>DN 23</p>  <p>M-Diamant = 15μ M-Diamond = 0.6 mil</p>	<p>DN 26</p>  <p>M-Saphir = 15μ M-Sapphire = 0.6 mil</p>	<p>DN 22</p>  <p>M 1 - Saphir = 23μ M 2 - Saphir = 23μ M 1 - Sapphire = 1 mil M 2 - Sapphire = 1 mil</p>	<p>DN 24</p> <p>M-Diamant = 15μ N-Saphir = 60μ M-Diamond = 0.6 mil N-Sapphire = 2.4 mil</p> <p>für Normal-, Mikro- und Stereo-Schallplatten for normal (78 rpm)-, micro- groove and stereo records pour disques normaux, micro et stéréo</p>
<p>207 514</p> <p>blau blue bleu</p>	<p>207 513</p> <p>gold gold or</p>	<p>207 512</p> <p>rot red rouge</p>	<p>207 518</p> <p>rot red rouge</p>	<p>207 517</p> <p>silber silver argent</p>
<p>7,60</p> <p>G</p>	<p>29,20</p> <p>G</p>	<p>6,20</p> <p>G</p>	<p>7,80</p> <p>G</p>	<p>31,20</p> <p>G</p>

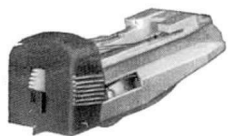
Empfohlene Verbraucherpreise incl. MWSt.

Geräte-Typ	Tonabnehmerkopf komplett	Kopf ohne System	Tonabnehmersystem mit Abtastnadel	Verwendungszweck Kenndaten
Model	Pick-up Head Complete	Head without Cartridge	Pick-up Cartridge with Stylus	Application Data
Appareil	Tête de lecture complète	Tête sans cellule	Cellule de pick-up avec pointe de lecture	Utilisation Données caractéristiques
1002 F / E	F 		CDS 2  Kristallsystem Crystal cartridge Cellule cristal	Normal- und Mikrorillen- Schallplatten Auflagekraft 9 p Normal (78 rpm)- and micro -groove records Tracking weight 9 p Disques normaux et micro Force d'appui 9 p
	Nicht mehr lieferbar No longer available Epuisé		Nicht mehr lieferbar No longer available Epuisé	
1002 / D	D 1 		CDS 2  Kristallsystem Crystal cartridge Cellule cristal	Normal- und Mikrorillen- Schallplatten Auflagekraft 9 p Normal (78 rpm)- and micro -groove records Tracking weight 9 p Disques normaux et micro Force d'appui 9 p
	Nicht mehr lieferbar No longer available Epuisé		Nicht mehr lieferbar No longer available Epuisé	

Empfohlene Verbraucherpreise incl. MWSt.

Abtastnadel

Stylus

Spezial-Abtastnadeln · Special styli · Pointes de lecture spéciales

Pointe de lecture

DN 2		DN 23		DN 26		DN 22		DN 24	
 M N M-Saphir = 23 μ N-Saphir = 60 μ M-Sapphire = 1 mil N-Sapphire = 2.4 mil		 M-Diamant = 15 μ M-Diamond = 0.6 mil		 M-Saphir = 15 μ M-Sapphire = 0.6 mil		 M 1 - Saphir = 23 μ M 2 - Saphir = 23 μ M 1 - Sapphire = 1 mil M 2 - Sapphire = 1 mil		 M-Diamant = 15 μ N-Saphir = 60 μ M-Diamond = 0.6 mil N-Sapphire = 2.4 mil für Normal -, Mikrorillen - und Stereo -Schallplatten for normal (78 rpm)-, micro - groove and stereo records pour disques normaux , micro et stéréo	
für Mikrorillen - und Stereo -Schallplatten		for micro -groove and stereo records		pour disques micro et stéréo		für Mikrorillen -Schallplatten for micro -groove records pour disques micro			
207 514	blau blue bleu	207 513	gold gold or	207 512	rot red rouge	207 518	rot red rouge	207 517	silber silver argent
7,60	G	29,20	G	6,20	G	7,80	G	31,20	G
DN 2		DN 23		DN 26		DN 22		DN 24	
 M N M-Saphir = 23 μ N-Saphir = 60 μ M-Sapphire = 1 mil N-Sapphire = 2.4 mil		 M-Diamant = 15 μ M-Diamond = 0.6 mil		 M-Saphir = 15 μ M-Sapphire = 0.6 mil		 M 1 - Saphir = 23 μ M 2 - Saphir = 23 μ M 1 - Sapphire = 1 mil M 2 - Sapphire = 1 mil		 M-Diamant = 15 μ N-Saphir = 60 μ M-Diamond = 0.6 mil N-Sapphire = 2.4 mil für Normal -, Mikrorillen - und Stereo -Schallplatten for normal (78 rpm)-, micro - groove and stereo records pour disques normaux , micro et stéréo	
für Mikrorillen - und Stereo -Schallplatten		for micro -groove and stereo records		pour disques micro et stéréo		für Mikrorillen -Schallplatten for micro -groove records pour disques micro			
207 514	blau blue bleu	207 513	gold gold or	207 512	rot red rouge	207 518	rot red rouge	207 517	silber silver argent
7,60	G	29,20	G	6,20	G	7,80	G	31,20	G

Empfohlene Verbraucherpreise incl. MWST.

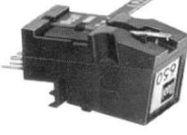
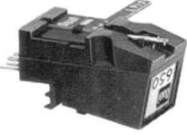
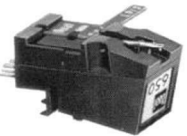
Geräte-Typ	Tonabnehmerkopf	Kopf ohne System	Tonabnehmersystem mit Abtastnadel	Verwendungszweck Kenndaten
Model	Pick-up Head Complete	Head without Cartridge	Pick-up Cartridge with Stylus	Application Data
Appareil	Tête de lecture complète	Tête sans cellule	Cellule de pick-up avec pointe de lecture	Utilisation Données caractéristiques
430		<p>Tonabnehmerkopf ist vom Gerät nicht abnehmbar</p> <p>The pick-up head is not removable from the unit</p> <p>La tête de lecture ne peut pas être séparée de l'appareil</p>	<p>CDS 650 / 6</p>  <p>Stereo-Keramiksistem Ceramic stereo cartridge Cellule céramique stéréo</p>	<p>Mikrorillen- und Stereo-Schallplatten Auflagekraft 3,5-4,5 p</p> <p>Micro-groove and stereo records Tracking weight 3.5-4.5 p</p> <p>Disques micro et stéréo. Force d'appui 3,5-4,5 p</p>
			218 865	
			29,50	E
421		<p>Tonabnehmerkopf ist vom Gerät nicht abnehmbar</p> <p>The pick-up head is not removable from the unit</p> <p>La tête de lecture ne peut pas être séparée de l'appareil</p>	<p>CDS 650 / 6</p>  <p>Stereo-Keramiksistem Ceramic stereo cartridge Cellule céramique stéréo</p>	<p>Mikrorillen- und Stereo-Schallplatten Auflagekraft 4 p</p> <p>Micro-groove and stereo records Tracking weight 4 p</p> <p>Disques micro et stéréo. Force d'appui 4 p</p>
			218 865	
			29,50	E
420		<p>Tonabnehmerkopf ist vom Gerät nicht abnehmbar</p> <p>The pick-up head is not removable from the unit</p> <p>La tête de lecture ne peut pas être séparée de l'appareil</p>	<p>CDS 650 / 6</p>  <p>Stereo-Keramiksistem Ceramic stereo cartridge Cellule céramique stéréo</p>	<p>Mikrorillen- und Stereo-Schallplatten Auflagekraft 4 p</p> <p>Micro-groove and stereo records Tracking weight 4 p</p> <p>Disques micro et stéréo. Force d'appui 4 p</p>
			218 865	
			29,50	E







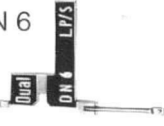
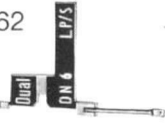

Empfohlene Verbraucherpreise incl. MWSt.

Abtastnadel

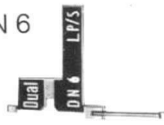
Stylus

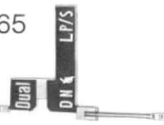
Spezial-Abtastnadeln · Special styli · Pointes de lecture spéciales

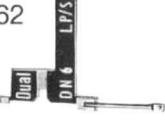
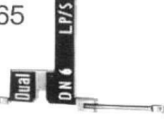
Pointe de lecture

 <p>DN 6</p> <p>M-Saphir = 15μ M-Saphir = 15μ M-Sapphire = 0.6 mil M-Sapphire = 0.6 mil</p>	 <p>DN 62</p> <p>M-Saphir = 15μ M-Saphir = 23μ M-Sapphire = 0.6 mil M-Sapphire = 1 mil</p>	 <p>DN 65</p> <p>M-Diamant = 15μ M-Diamond = 0.6 mil</p>	 <p>DN 64</p> <p>M-Diamant = 15μ M-Saphir = 23μ M-Diamond = 0.6 mil M-Sapphire = 1 mil</p>	
<p>für Mikrorillen- und Stereo-Schallplatten</p>		<p>for micro-groove and stereo records</p>		<p>pour disques micro et stéréo</p>
<p>211 972</p>	<p>211 973</p>	<p>212 035</p>	<p>211 974</p>	
<p>9,80 G</p>	<p>9,80 G</p>	<p>31,20 G</p>	<p>32,50 G</p>	
 <p>DN 6</p> <p>M-Saphir = 15μ M-Saphir = 15μ M-Sapphire = 0.6 mil M-Sapphire = 0.6 mil</p>	 <p>DN 62</p> <p>M-Saphir = 15μ M-Saphir = 23μ M-Sapphire = 0.6 mil M-Sapphire = 1 mil</p>	 <p>DN 65</p> <p>M-Diamant = 15μ M-Diamond = 0.6 mil</p>	 <p>DN 64</p> <p>M-Diamant = 15μ M-Saphir = 23μ M-Diamond = 0.6 mil M-Sapphire = 1 mil</p>	
<p>für Mikrorillen- und Stereo-Schallplatten</p>		<p>for micro-groove and stereo records</p>		<p>pour disques micro et stéréo</p>
<p>211 972</p>	<p>211 973</p>	<p>212 035</p>	<p>211 974</p>	
<p>9,80 G</p>	<p>9,80 G</p>	<p>31,20 G</p>	<p>32,50 G</p>	
 <p>DN 6</p> <p>M-Saphir = 15μ M-Saphir = 15μ M-Sapphire = 0.6 mil M-Sapphire = 0.6 mil</p>	 <p>DN 62</p> <p>M-Saphir = 15μ M-Saphir = 23μ M-Sapphire = 0.6 mil M-Sapphire = 1 mil</p>	 <p>DN 65</p> <p>M-Diamant = 15μ M-Diamond = 0.6 mil</p>	 <p>DN 64</p> <p>M-Diamant = 15μ M-Saphir = 23μ M-Diamond = 0.6 mil M-Sapphire = 1 mil</p>	
<p>für Mikrorillen- und Stereo-Schallplatten</p>		<p>for micro-groove and stereo records</p>		<p>pour disques micro et stéréo</p>
<p>211 972</p>	<p>211 973</p>	<p>212 035</p>	<p>211 974</p>	
<p>9,80 G</p>	<p>9,80 G</p>	<p>31,20 G</p>	<p>32,50 G</p>	

Empfohlene Verbraucherpreise incl. MWST.

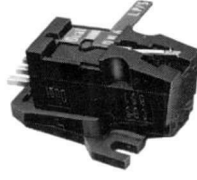
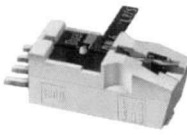
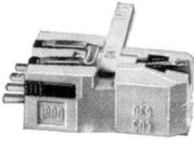
Geräte-Typ	Tonabnehmerkopf komplett	Kopf ohne System	Tonabnehmersystem mit Abtastnadel	Verwendungszweck Kenndaten
Model	Pick-up Head complete	Head without Cartridge	Pick-up Cartridge with Stylus	Application Data
Appareil	Tête de lecture complète	Tête sans cellule	Cellule de pick-up avec pointe de lecture	Utilisation Données caractéristiques
412 410 410 B		Tonabnehmerkopf ist vom Gerät nicht abnehmbar The pick-up head is not removable from the unit La tête de lecture ne peut pas être séparée de l'appareil	CDS 651 / 6  Stereo-Keramiksystem Ceramic stereo cartridge Cellule céramique stéréo	Mikrorillen- und Stereo-Schallplatten Auflagekraft 3,5-4,5 p Micro- groove and stereo records Tracking weight 3.5-4.5 p Disques micro et stéréo Force d'appui 3,5-4,5 p
			218 885	
			29,50	E
412 410 410 B		Tonabnehmerkopf ist vom Gerät nicht abnehmbar The pick-up head is not removable from the unit La tête de lecture ne peut pas être séparée de l'appareil	CDS 641 / 6  Stereo-Kristallsystem Crystal stereo cartridge Cellule cristal stéréo	Mikrorillen- und Stereo-Schallplatten Auflagekraft 4 p Micro- groove and stereo records Tracking weight 4 p Disques micro et stéréo . Force d'appui 4 p
			Ersatz: Replace: CDS 651 / 6 Remplacement:	
412 410 410 B		Tonabnehmerkopf ist vom Gerät nicht abnehmbar The pick-up head is not removable from the unit La tête de lecture ne peut pas être séparée de l'appareil	CDS 630 / 5  Stereo-Kristallsystem Crystal stereo cartridge Cellule cristal stéréo	Normal-, Mikrorillen- und Stereo-Schallplatten Auflagekraft 3,5-4,5 p Normal (78 rpm)-, micro-groove and stereo records Tracking weight 3.5-4.5 p Disques micro et stéréo . Force d'appui 3,5-4,5 p
			Ersatz: Replace: CDS 651 / 6 Remplacement:	







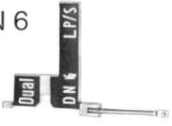

Empfohlene Verbraucherpreise incl. MWSt.

Abtastnadel

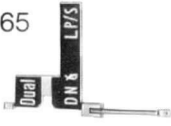

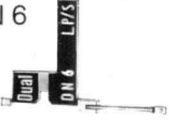
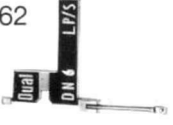
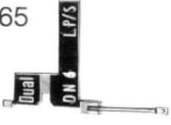
Stylus

Spezial-Abtastnadeln · Special styli · Pointes de lecture spéciales

Pointe de lecture

<p>DN 6</p>  <p>M-Saphir = 15μ M-Saphir = 15μ M-Sapphire = 0.6 mil M-Sapphire = 0.6 mil</p>	<p>DN 62</p>  <p>M-Saphir = 15μ M-Saphir = 23μ M-Sapphire = 0.6 mil M-Sapphire = 1 mil</p>	<p>DN 65</p>  <p>M-Diamant = 15μ M-Diamond = 0.6 mil</p>	<p>DN 64</p>  <p>M-Diamant = 15μ M-Saphir = 23μ M-Diamond = 0.6 mil M-Sapphire = 1 mil</p>	<p>DN 63</p> <p>M-Saphir = 15μ N-Saphir = 60μ M-Sapphire = 0.6 mil N-Sapphire = 2.4 mil</p> <p>für Normal-, Mikrorillen- und Stereo-Schallplatten</p> <p>for normal (78 rpm)-, micro-groove and stereo records</p> <p>pour disques normaux, micro et stéréo</p>
<p>211 972</p> <p>9,80 G</p>	<p>211 973</p> <p>9,80 G</p>	<p>212 035</p> <p>31,20 G</p>	<p>211 974</p> <p>32,50 G</p>	<p>212 034</p> <p>9,80 G</p>
<p>DN 6</p>  <p>M-Saphir = 15μ M-Saphir = 15μ M-Sapphire = 0.6 mil M-Sapphire = 0.6 mil</p>	<p>DN 62</p>  <p>M-Saphir = 15μ M-Saphir = 23μ M-Sapphire = 0.6 mil M-Sapphire = 1 mil</p>	<p>DN 65</p>  <p>M-Diamant = 15μ M-Diamond = 0.6 mil</p>	<p>DN 64</p>  <p>M-Diamant = 15μ M-Saphir = 23μ M-Diamond = 0.6 mil M-Sapphire = 1 mil</p>	<p>DN 63</p> <p>M-Saphir = 15μ N-Saphir = 60μ M-Sapphire = 0.6 mil N-Sapphire = 2.4 mil</p> <p>für Normal-, Mikrorillen- und Stereo-Schallplatten</p> <p>for normal (78 rpm)-, micro-groove and stereo records</p> <p>pour disques normaux micro et stéréo</p>
<p>211 972</p> <p>9,80 G</p>	<p>211 973</p> <p>9,80 G</p>	<p>212 035</p> <p>31,20 G</p>	<p>211 974</p> <p>32,50 G</p>	<p>212 034</p> <p>9,80 G</p>
<p>DN 5</p>  <p>M-Saphir = 15μ N-Saphir = 60μ M-Sapphire = 0.6 mil N-Sapphire = 2.4 mil</p>	<p>DN 55</p>  <p>M-Saphir = 15μ M-Saphir = 15μ M-Sapphire = 0.6 mil M-Sapphire = 0.6 mil</p>	<p>DN 56</p>  <p>M-Saphir = 15μ M-Diamant = 15μ M-Sapphire = 0.6 mil M-Diamond = 0.6 mil</p>		
<p>202 529</p> <p>9,20 G</p>	<p>217 965</p> <p>9,20 G</p>	<p>217 966</p> <p>31,20 G</p>		

Empfohlene Verbraucherpreise incl. MWSt.

Geräte-Typ	Tonabnehmerkopf komplett	Kopf ohne System	Tonabnehmersystem mit Abtastnadel	Verwendungszweck Kenndaten
Model	Pick-up Head Complete	Head without Cartridge	Pick-up Cartridge with Stylus	Application Data
Appareil	Tête de lecture complète	Tête sans cellule	Cellule de pick-up avec pointe de lecture	Utilisation Données caractéristiques
400 300 A		<p>Tonabnehmerkopf ist vom Gerät nicht abnehmbar</p> <p>The pick-up head is not removable from the unit</p> <p>La tête de lecture ne peut pas être séparée de l'appareil</p>	<p>CDS 520 / 3</p>  <p>Stereo-Kristallsystem Crystal stereo cartridge Cellule cristal stéréo</p>	<p>Normal-, Mikrorippen- und Stereo-Schallplatten Auflagekraft 5,5 p</p> <p>Normal (78 rpm)-, micro-groove and stereo records Tracking weight 5.5 p</p> <p>Disques normaux, micro et stéréo Force d'appui 5,5 p</p>
			207 562 weiß/white/blanc	
			28,—	E
400 B 300 B		<p>Tonabnehmerkopf ist vom Gerät nicht abnehmbar</p> <p>The pick-up head is not removable from the unit</p> <p>La tête de lecture ne peut pas être séparée de l'appareil</p>	<p>CDS 521 / 3</p>  <p>Stereo-Kristallsystem Crystal stereo cartridge Cellule cristal stéréo</p>	<p>Normal-, Mikrorippen- und Stereo-Schallplatten Auflagekraft 5,5 p</p> <p>Normal (78 rpm)-, micro-groove and stereo records Tracking weight 5.5 p</p> <p>Disques normaux, micro et stéréo Force d'appui 5,5 p</p>
			Ersatz: CDS 520 / 3 Replace: CDS 520 / 3 Remplacement: CDS 520 / 3	
300		<p>Tonabnehmerkopf ist vom Gerät nicht abnehmbar</p> <p>The pick-up head is not removable from the unit</p> <p>La tête de lecture ne peut pas être séparée de l'appareil</p>	<p>CDS 320 / 3</p>  <p>Stereo-Kristallsystem Crystal stereo cartridge Cellule cristal stéréo</p>	<p>Normal-, Mikrorippen- und Stereo-Schallplatten Auflagekraft 5,5 p</p> <p>Normal (78 rpm)-, micro-groove and stereo records Tracking weight 5.5 p</p> <p>Disques normaux, micro et stéréo Force d'appui 5,5 p</p>
			207 545 rot/red/rouge	
			27,—	E











Empfohlene Verbraucherpreise incl. MWSt.

Abtastnadel

Stylus

Spezial-Abtastnadeln · Special styli · Pointes de lecture spéciales

Pointe de lecture

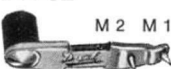
DN 3		DN 23		DN 26		DN 32		DN 34	
 N M M-Saphir = 15 μ N-Saphir = 60 μ M-Sapphire = 0.6 mil N-Sapphire = 2.4 mil		 M-Diamant = 15 μ M-Diamond = 0.6 mil		 M-Saphir = 15 μ M-Sapphire = 0.6 mil		 M 2 M 1 M 1 - Saphir = 15 μ M 2 - Saphir = 23 μ M 1 - Sapphire = 0.6 mil M 2 - Sapphire = 1 mil		M-Diamant = 15 μ N-Saphir = 60 μ M-Diamond = 0.6 mil N-Sapphire = 2.4 mil für Normal-, Mikro rillen- und Stereo -Schallplatten for normal (78 rpm)-, micro -groove and stereo records pour disques normaux , micro et stéréo	
207 542	braun brown brun	207 513	gold gold or	207 512	rot red rouge	207 540	rot red rouge	207 541	silber/braun silver/brown argent/brun
7,60	G	29,20	G	6,20	G	7,60	G	31,20	G
 N M M-Saphir = 15 μ N-Saphir = 60 μ M-Sapphire = 0.6 mil N-Sapphire = 2.4 mil		 M-Diamant = 15 μ M-Diamond = 0.6 mil		 M-Saphir = 15 μ M-Sapphire = 0.6 mil		 M 2 M 1 M 1 - Saphir = 15 μ M 2 - Saphir = 23 μ M 1 - Sapphire = 0.6 mil M 2 - Sapphire = 1 mil		M-Diamant = 15 μ N-Saphir = 60 μ M-Diamond = 0.6 mil N-Sapphire = 2.4 mil für Normal-, Mikro rillen- und Stereo -Schallplatten for normal (78 rpm)-, micro -groove and stereo records pour disques normaux , micro et stéréo	
207 542	braun brown brun	207 513	gold gold or	207 512	rot red rouge	207 540	rot red rouge	207 541	silber/braun silver/brown argent/brun
7,60	G	29,20	G	6,20	G	7,60	G	31,20	G
 N M M-Saphir = 15 μ N-Saphir = 60 μ M-Sapphire = 0.6 mil N-Sapphire = 2.4 mil		 M-Diamant = 15 μ M-Diamond = 0.6 mil		 M-Saphir = 15 μ M-Sapphire = 0.6 mil		 M 2 M 1 M 1 - Saphir = 15 μ M 2 - Saphir = 23 μ M 1 - Sapphire = 0.6 mil M 2 - Sapphire = 1 mil		M-Diamant = 15 μ N-Saphir = 60 μ M-Diamond = 0.6 mil N-Sapphire = 2.4 mil für Normal-, Mikro rillen- und Stereo -Schallplatten for normal (78 rpm)-, micro -groove and stereo records pour disques normaux , micro et stéréo	
207 542	braun brown brun	207 513	gold gold or	207 512	rot red rouge	207 540	rot red rouge	207 541	silber/braun silver/brown argent/brun
7,60	G	29,20	G	6,20	G	7,60	G	31,20	G

Empfohlene Verbraucherpreise incl. MWSt.

Abbildung	Verwendungszweck Kenndaten	Empfohlene Verbraucherpreise je Stück incl. MWSt. DM
Illustration	Application Data	Warengruppe
Figure	Utilisation Données caractéristiques	
	<p>Verbindungsstück eine Seite 1 Klinkenkupplung 3-polig, 6,35 mm \varnothing andere Seite 1 Stereo-Würfelstecker DIN 45 327 5-polig</p> <p>Adapter three pole stereo line socket 6,35 mm to five pole headset plug to DIN 45 327</p> <p>Raccord reliant 1 fiche femelle téléphonique \varnothing 6,35 mm avec 1 fiche mâle stéréo 5 contacts DIN 45 327</p>	<p>229 215</p> <hr/> <p>6,90 E</p>
	<p>Verbindungsstück 1 Seite 2 Klinkenkupplungen 3-polig, 6,35 mm \varnothing andere Seite 1 Klinkenstecker 3-polig, 6,35 mm \varnothing</p> <p>Adapter two 6,35 mm stereo line socket to stereo jack plug 6,35 mm</p> <p>Raccord reliant 2 fiche téléphonique tri-polaire femelle \varnothing 6,35 mm avec 1 fiche mâle téléphonique tri-polaire \varnothing 6,35 mm</p>	<p>229 217</p> <hr/> <p>11,30 E</p>
	<p>Verbindungsstück eine Seite Klinkenkupplung 3-polig, 6,35 mm \varnothing andere Seite 2 Familienstecker</p> <p>Adapter 6,35 mm stereo line socket to two family loudspeaker plugs</p> <p>Raccord reliant 1 fiche téléphonique tri-polaire femelle \varnothing 6,35 avec 2 fiches mâles (de famille)</p>	<p>229 219</p> <hr/> <p>12,20 E</p>
	<p>An Geräte mit 1/4" Koaxial-Buchsen</p> <p>For units with 1/4" coaxial jacks</p> <p>Sur appareils avec fiche jack 1/4"</p>	<p>221 107</p> <hr/> <p>21,50 E</p>
	<p>An alle Lautsprecher- und Kopfhörer- Ausgänge nach DIN 41 529.</p> <p>To all loudspeaker outputs and headsets outputs according to DIN 41 529.</p> <p>Sur toutes les prises de sortie pour haut- parleurs et écouteurs suivant DIN 41 529.</p>	<p>221 110</p> <hr/> <p>22,50 E</p>

Typ und Abbildung

Type and Illustration

Type et Figure

Empfohlene
Verbraucherpreise
je Stück incl. MWSt.
DM

Warengruppe

HiFi-Stereo-Kopfhörer **DK 710**
High Fidelity Stereo Headsets **DK 710**
Casque d'écoute stéréo HiFi **DK 710**

Übertragungsbereich · Frequency response · Plage de transmission
20 ... 20 000 Hz

Impedanz · Impedance · Impédance
400 Ω / System
400 Ω / Système

Beide Systeme regelbar bis -20 dB
Bothe Systems adjustable to -20 dB
Tous les deux Systèmes réglable jusqu'a -20 dB

Gewicht · Weight · Poids
~ 530 g



DK 710

229 401

198,- C

HiFi-Stereo-Kopfhörer **DK 700/1**
High Fidelity Stereo Headsets **DK 700/1**
Casque d'écoute stéréo HiFi **DK 700/1**

Übertragungsbereich · Frequency response · Plage de transmission
20 ... 20 000 Hz

Impedanz · Impedance · Impédance
400 Ω / System
400 Ω / Système

Gewicht · Weight · Poids
~ 635 g



DK 700/1

220 873

164,- C

HiFi-Stereo-Kopfhörer **DK 210**
High Fidelity Stereo Headsets **DK 210**
Casque d'écoute stéréo HiFi **DK 210**

Übertragungsbereich · Frequency response · Plage de transmission
20 ... 17 000 Hz

Impedanz · Impedance · Impédance
400 Ω / System
400 Ω / Système

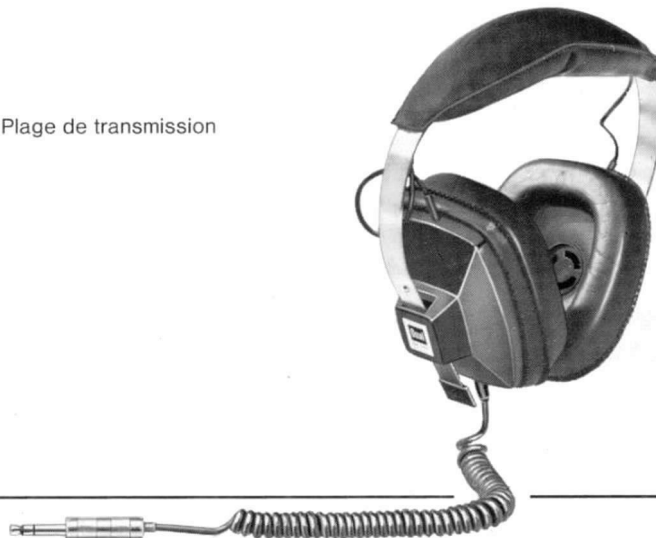

Gewicht · Weight · Poids
~ 400 g



DK 210

229 404

88,- C

Typ und Abbildung Type and Illustration Type et Figure	Kenndaten Data Données caractéristiques	No. Empfohlene Verbraucherpreise je Stück incl. MWSt. DM Warengruppe
<p>Dynamisches Mikrofon MB 1001 Dynamic Microphone MB 1001 Microphone dynamique MB 1001</p> 	<p>Das Mikrofon eignet sich für Sprach- und Musikaufnahmen und ist durch Abnehmen des Tischfußes auch als Handmikrofon zu verwenden.</p> <p>Charakteristik Kugel Übertragungsbereich 80–15 000 Hz Empfindlichkeit 0,25 mV / μb Impedanz 700 Ohm Steckverbindung 3pol. Normstecker Mas 30 Steckerbelegung Kontakt 3 = System Kontakt 2 = Masse Kontakt 1 = frei</p> <p>Suitable for speech and music recordings, with stand detachable.</p> <p>Features ball characteristics Frequency response 80–15 000 Hz Sensitivity 0.25 mV / μb Impedance 700 ohms Connection 3-pole DIN plug Plug outlet point 3 = system point 2 = ground point 1 = free</p> <p>Le microphone est propre à des enregistrements de paroles et musique, le support est démontable.</p> <p>Caractéristique boule Bande passante 80–15 000 Hz Sensibilité 0,25 mV / μb Impédance 700 ohm Raccordement fiche à 3 pôles Points de raccordement point 3 = système point 2 = masse point 1 = pas occupé</p>	<p>209 088</p> <p>34,- L</p>
<p>Dynamisches Richtmikrofon MB 2002 Dynamic Directional Microphone MB 2002 Microphone dynamique directionnel MB 2002</p> 	<p>Hochwertiges Tauchspulenmikrofon für Sprach- und Musikaufnahmen. Das Mikrofon entspricht den Forderungen der Heimstudio-Technik nach DIN 45500. Das Tischstativ mit Gelenk ist abnehmbar.</p> <p>Charakteristik Niere Übertragungsbereich 50–16 000 Hz Rückwärtsdämpfung > 15 dB bei 180° Empfindlichkeit 0,24 mV / μb Impedanz 700 Ohm Steckverbindung 3pol. Normstecker Mas 30 Steckerbelegung Kontakt 3 = System Kontakt 2 = Masse</p> <p>Ausstattung: Mikrofon mit Anschlußkabel und Stecker, Tischstativ mit Halteklammer $\frac{3}{8}$".</p> <p>High quality moving coil microphone for music and speech recording. This microphone meets all the required specifications of the German Industry Standard DIN 45500 for home high-fidelity music systems. The table stand with tripod is detachable.</p> <p>Features cardioide Front to back ratio > 15 dB at 180° Frequency response 50–16 000 Hz Sensitivity 0.24 mV / μb Impedance 700 ohms Connection 3-pole DIN plug Plug outlet point 3 = system point 2 = ground</p> <p>Equipment: Microphone with connecting cable and plug, table stand with holding clamp $\frac{3}{8}$".</p> <p>Microphone dynamique à caractéristique directionnelle à haute performance pour enregistrements de parole et de musique. Le microphone correspond à la normalisation DIN 45500. Pied de table et articulation au pas démontable.</p> <p>Caractéristique cardioide Discrimination avant-arrière > 15 dB à 180° Bande passante 50–16 000 Hz Sensibilité 0,24 mV / μb Impédance 700 ohm Raccordement 3 pôles Points de raccordement point 3 = système point 2 = masse</p> <p>Equipement: microphone avec câble de raccordement et fiche, pied de table et articulation au pas $\frac{3}{8}$".</p>	<p>217 929</p> <p>78,- L</p>

Typ und Abbildung

Type and Illustration

Type et Figure

Kenndaten

Data

Données caractéristiques

No.

**Empfohlene
Verbraucherpreise
je Stück incl. MWSt.
DM**

Warengruppe

Dynamisches Stereo-Mikrofon **MB 1003**
Dynamic stereo Microphone **MB 1003**
Microphone dynamique stéréo **MB 1003**

Das Mikrofon eignet sich für alle monauralen und stereophonen Aufnahmetechniken von Sprache und Musik. Die beiden Systeme sind auf dem Tischstativ drehbar angeordnet, können aber auch abgenommen und als Einzelmikrofone verwendet werden. Das beigelegte gegabelte Kabel dient zum Anschluß des Stereo-Mikrofons an eine 5-polige Normsteckdose.

Technische Daten

Charakteristik	2 x Niere
Übertragungsbereich (nach Sollkurve)	60–15 000 Hz, Abweichung $\leq \pm 3$ dB
Rückwärtsdämpfung	15 dB bei 180°
Empfindlichkeit	0,25 mV / μ bar
Impedanz	700 Ohm
Steckverbindung	2 x 3-poliger Normstecker nach DIN 41 524
Steckerbelegung	Kontakt 3 = System Kontakt 2 = Masse Kontakt 1 = frei
Steckerbelegung des gegabelten Kabels	Kontakt 5 = linker Kanal Kontakt 3 = rechter Kanal Kontakt 2 = Masse

Das Dual MB 1003 übertrifft in allen Meßwerten die nach DIN 45 500 festgelegten Anforderungen an Geräte der Heimstudioteknik (HiFi).

The microphone can be used for all types of recording technics, both monaural and stereophonic. Both systems are turnable, but also removable and able to be used as single microphones. By means of the twin-pronged cable, the stereo microphone can be connected to a 5-pole DIN socket.

Technical data

Characteristics	2 x cardioid pattern
Frequency response (according to nominal curve)	60–15 000 Hz, deviation $\leq \pm 3$ dB
Backwards damping	15 dB at 180°
Sensitivity	0,25 mV / μ bar
Impedance	700 ohms
Connection	2 x 3-pole plug, DIN 41 524
Plug outlet	point 3 = system point 2 = ground point 1 = free
Plug outlet of the twin-pronged cable	point 5 = left channel point 3 = right channel point 2 = ground.

The microphone MB 1003, surpasses all values laid down under DIN 45 500 for hifi stereo home studio equipment.

Ce microphone est propre à tous les genres de techniques d'enregistrement, monaurales et stéréophoniques. Sur le support de table les deux systèmes sont disposés tournable. Ils peuvent être enlevés et utilisés comme microphones individuelles. A l'aide du câble enfourché le microphone stéréo peut être raccordé à une douille à 5 pôles, suivant DIN.

Caractéristiques techniques

Caractéristique	2 x cardioïde
Courbe de fréquence (suivant la courbe nominale)	60–15 000 Hz, tolérance $\leq \pm 3$ dB
Amortissement en sens inverse	15 dB à 180°
Sensibilité	0,25 mV / μ bar
Impédance	700 Ohm
Raccordement	2 fiches à 3 pôles, DIN 41 524
Points de raccordement	point 3 = système point 2 = masse point 1 = libre
Points de raccordement du câble enfourché	point 5 = canal de gauche point 3 = canal de droite point 2 = masse

L'appareil dépasse pour toutes les valeurs de mesure les prescriptions de la normalisation DIN 45 500 pour appareils à haute fidélité de salon (hi-fi).



209 090

109,- L

Werkvertretungen Inland

Platz	Firma	Straße	Telefon	FS-Nr.	Postfach
3501 Bergshausen Kassel	Bruno Herz	Ostring 20	(0561) 550 11/12	99802	X
1000 Berlin 41 (Friedenau)	H. F. Rohde	Schmargendorfer Str. 17	(03 11) 851 20 11	0183460	
2800 Bremen 41	Rolf Kern	Sonneberger Str. 18	(0421) 469091	0244305	419180
4600 Dortmund	Hubert Kampschulte ERAK	Ernst-Mehlich-Str. 6II	(0231) 528787-89		
4000 Düsseldorf	H. W. Kleemann	Lindenstr. 47	(0211) 684541/42	8586436	
6236 Eschborn bei Frankfurt	Werner Hopf KG	Frankfurter Str. 7	(06196) 4095	04 15605	1260
7012 Fellbach bei Stuttgart	Helmut Braun KG	Schorndorfer Str. 40	(07 11) 587585/86	07254626	1203
5020 Frechen 1 bei Köln	Michels KG	Max-Planck-Str. 13	(02234) 6056	0889226	1640
7800 Freiburg	Wilhelm Michels KG	Wiesentalstr. 29	(0761) 40966/67	0772465	1048
8034 Germering/ München	Heinz Seibt	Industriestr. 20	(08 11) 842051-53	0529851	
2000 Hamburg 50	Georg Himstedt	Bernstorffstr. 76	(04 11) 4370 12	0212866	
3000 Hannover- Hainholz	Gerhard Bartel KG	Meelbaumstr. 7	(05 11) 67 10 11	0923771	
6750 Kaiserslautern	Hans Hettergott KG	Im Reiserfeld 10	(0631) 49393		
7500 Karlsruhe	Hans Hettergott KG	Körnerstr. 33-35	(0721) 22829		
5400 Koblenz	Michels KG	Rizzastr. 28	(0261) 34083/4	862582	1608
6800 Mannheim	Hans Hettergott KG	H 7/28	(0621) 25561/77	0462579	1001
8500 Nürnberg	Werner Weidner	Heideloffstr. 23	(09 11) 445651/53	0622848	2747
4500 Osnabrück	Walter Diekhöner	Martinistr. 63	(0541) 45071/72	094713	1664
7980 Ravensburg	Wilhelm Michels GmbH & Co.	Hindenburgstr. 36	(0751) 3944/45	732944	1850
6600 Saarbrücken	Josef Bucker	Heinrich-Böcking-Str. 7	(0681) 67071/72		

Kundendienststellen Inland

Platz	Firma	Straße	Telefon	FS-Nr.	Postfach
5100 Aachen	Heinz Marschik	Lothringer Str. 37	(0241) 37181		
8900 Augsburg	Hobi-Service G. Hoffmann, Kl. Bienek	Schillstr. 10	(0821) 75696		
3501 Bergshausen Kassel	Bruno Herz	Ostring 20	(0561) 55011/12	99802	X
1000 Berlin 41 (Friedenau)	H. F. Rohde	Schmargendorfer Str. 17	(0311) 8512011	0183460	
4800 Bielefeld	Walter Diekhöner	Hauptstr. 247	(0521) 23071/72		
3300 Braunschweig	Willi Adler	Bültenweg 93	(0531) 331405/331269		
2800 Bremen 41	Rolf Kern	Sonneberger Str. 18	(0421) 469091	0244305	419180
4600 Dortmund	Hubert Kampschulte ERAK	Ernst-Mehlich-Str. 6II	(0231) 528787-89		
4000 Düsseldorf	H. W. Kleemann	Lindenstr. 47	(0211) 684541/42	8586436	
6236 Eschborn bei Frankfurt	Werner Hopf KG	Frankfurter Str. 7	(06196) 4095	0415605	1260
4300 Essen 1	Gerstner & Marquardt OHG	Münchener Str. 48	(02141) 239745/46		
7012 Fellbach bei Stuttgart	Helmut Braun KG	Schorndorfer Str. 40	(0711) 587585/86	07254626	1203
2390 Flensburg	Radio-Jepsen	Bahnhofstr. 23	(0461) 22272		
5020 Frechen 1 bei Köln	Michels KG	Max-Planck-Str. 13	(02234) 6056	0889226	1640
7800 Freiburg	Wilhelm Michels KG	Wiesentalstr. 29	(0761) 40966/67		1048
8034 Germering/ München	Heinz Seibt	Industriestr. 20	(0811) 842051-53	0529851	
2000 Hamburg 50	Georg Himstedt	Bernstorffstr. 76	(0411) 437012	0212866	
3000 Hannover- Hainholz	Gerhard Bartel KG	Meelbaumstr. 7	(0511) 671011	0923771	
3000 Hannover M	Fritz Kotte	Blumenstr. 1	(0511) 21291		
6750 Kaiserslautern	Hugo Kuntz	Lutrinastr. 12	(0631) 65785		
7500 Karlsruhe 1	Heinz G. Metzger	Degenfeldstr. 4a	(0721) 65742		
8960 Kempten	F. Gruber	Parkhaus am Rathaus	(0831) 24621		
2300 Kiel	Hans-Willy Föh	Langer Segen 8-10	(0431) 41457		
5400 Koblenz	Michels KG	Rizzastr. 28	(0261) 34083/4	862582	1608
6800 Mannheim 1	W. Streicher	U 6/6	(0621) 21157		
4400 Münster	Emil Neher	Hammer Str. 230	(0251) 77119/110		
7910 Neu-Ulm	Alfred Semler	Max-Eyth-Str. 2	(0731) 78139		
8500 Nürnberg	Werner Weidner	Heideloffstr. 23	(0911) 445651/53	0622848	2747
4500 Osnabrück	Walter Diekhöner	Martinistr. 63	(0541) 45071/72	094713	1664
7980 Ravensburg	Wilhelm Michels GmbH & Co.	Hindenburgstr. 36	(0751) 3944/45	732944	1850
8400 Regensburg	Heinrich Lederer	Am Vitusbach 19	(0941) 90601		
6600 Saarbrücken	Josef Bücken	Heinrich-Böcking-Str. 7	(0681) 67071/72		
5500 Trier	Manfred Müller	Aachener Str. 53	(0651) 79976		
8700 Würzburg	Karl Rückert	Herzogenstr. 11	(0931) 54387		

Vertretungen EUROPA

Belgien	GECOBOIS S.A. Rue Emile Wauters 119 1020-Bruxelles	Italien	RAPIT S.R.L. Via S. Gregorio, 45 I-20124 Milano
Dänemark	ELTON ELECTRONICS A.S. Dronning Olgas Vej 20-22 DK-2000 Kopenhagen F	Luxembourg	ALBERT LOSCHETTER & FILS 41, Boulevard Prince Henri Luxembourg
Finnland	TELAGENT OY Valimontie 2 Helsinki-37	Malta	AUSONIA LTD. 48, Victoria Av. Sliema
Frankreich	VOXAL S.A. 27/33 Av. des Champs Elysées 75008 Paris HOHL & DANNER S.A. 6, Rue Livio 67024 Strasbourg-Meinau MARESON Le Matériel de Reproduction Sonore 4 ème rue/Zone Industrielle 13127 Vitrolles MARESON 14, Rue Pierre Corneille 69006 Lyon (6e) MARESON 60, rue Bayard 31000 Toulouse	Niederlande	REMA ELECTRONICS N.V. Bronckhorststraat 14 Amsterdam-Z
		Norwegen	NEBB Norsk Elektrisk & Brown Boveri Postfach 429, Sentrum Oslo 1
		Österreich	OTHMAR SCHIMEK Willibald-Hauthaler-Str. 23 A-5020 Salzburg OTHMAR SCHIMEK Siebensterngasse 13 1070 Wien
Gibraltar	A.D. COHEN LTD. 305 Main Street Gibraltar	Portugal	GENERAL ELECTRIC PORTUGUESA Rua do Norte, 5 Lissabon 2
Griechenland	LAMBROPOULOS BROS. LTD. Paparigopoulou 17 & Praxitelous Streets Athènes 124	Schweden	TONOLA HiFi AB Fack S-17203 Sundbyberg 3 Schweden
Groß- britannien	A.C. FARNELL (LEEDS) LTD. Farnell House 81 Kirkstall Road LEEDS LS 3 1 HR England	Schweiz	DEWALD AG Seestraße 561 CH-8038 Zürich
Island	RADIOBUDIN h.f. Klapparstig 26 Reykjavik P.O. Box 424	Spanien	INDUSTRIAS BETTOR, S.A. Balmes, 56 Pral. Barcelona (7)

Vertretung ÜBERSEE

Algerien	Ets. Le MEUBLE 2, Rue Didouche Mourad Alger	Libyen	LIBYAN ELECTRONICS CO. P.O. Box 2143 Benghazi
Australien	FRED A. FALK & CO. PTY. LTD. 28 King Street Rockdale, N.S.W.	Marokko	RADIO VOX G. W. Keucke 24 et 26 Rue Clemenceau Casablanca
Bolivien	Sociedad Comercialé Industrial HANSA LIMITADA Cajòn Postal 1402 LA PAZ	Peru	IMACO INTERNATIONAL MACHINERY CO. Apartado 1843 Lima
Brasilien	MONYMAR Produtos Electronicos Ltd. Alameda dos Maracatins, 161/165 Caixa Postal 30.049 São Paulo	Philippinen	SIGMA-MARIWASA, INC. P.O. Box 1717 Manila
Canada	NORESCO (ONTARIO) LTD. 425 Alness Street Downsview, Ont.	Reunion	DINDAR-CONFORT Rue Maréchal Leclerc Saint Denis
Chile	CANTOLLA Y CIA S.A.C.I. Casilla 9954 Santiago de Chile	Senegal	BARADERIE FRERES B.P. 2081 Dakar
Elfenbein- küste	PEYRISSAC-COTE-D'IVOIRE 23, Ave. du Général de Gaulle B.P. 1272 Abidjan	Singapur	JEBSEN & JESSEN (S) PTE. LTD. P.O. Box 2444 Singapore 1
Hongkong	JEBSEN & CO. Prince's Building P.O.Box 97 Hongkong	Republik Südafrika	FRANK & HIRSCH (PTY.)LTD. P.O.B. 1803 Cor. Bree & Nugget Sts. Johannesburg
Iran	TEHERAN ELECTRIC CO. LTD. Iranshahr Avenue, No. 90/4 Teheran	USA	UNITED AUDIO PRODUCTS, INC. 120 So. Columbus Ave. Mount Vernon, N.Y. 10553
Japan	TOSY CORPORATION 26-17 Shibuya 3-chome Shibu yaku Tokio 150	Venezuela	DELVALLE HNOS. C.A. Apartado 2352 Edificio Karam Avenida Urdaneta Caracas
Libanon	TUTUNJAN CORPORATION S.A. P.O. Box 610 Beirut		

Dual

Service



**Zur Ausübung eines guten
Service liefern wir:**

Nadelmikroskope (Abbildung)
Stroboskopscheiben
Reparaturböcke
Federwaagen
Schmierstoffkästen

**For providing an excellent
service we have available:**

Stylus microscopes (illustration)
Stroboscope discs
Repair stands
Spring scales
Lubrication kits

**Pour l'exécution d'un bon
«Service après-vente»,
nous fournissons:**

Loupe pour pointes de lecture (figure)
Disques stroboscopiques
Support pour réparation des changeurs
Pèse-bras
Étuis contenant des produits de
lubrification

Dual Gebrüder Steidinger - 7742 St. Georgen/Schwarzwald



Zubehör für Tonbandgeräte

unverb. Richtpreise
einschl. ohne
MWSt. MWSt.

Typenbezeichnung/Abbildung

E.-Nummern

Anwendung/Ausführung

Teleset 4



348 065 064

Alle Tonbandgeräte „magnetophon“
Dynamischer Kopfhörer in Stereo-Ausführung.
Impedanz 2 x 3300 Ω ,
Frequenzumfang 30 ... 18 000 Hz,
Stecker Mas 50 S/3 + 5 = Ton,
1 = Masse,
Kabellänge 2,50 m,
Hörmuscheln flüssigkeitsgepolstert
auf Kopfbügel verschiebbar,
Farbkennzeichnung Rot = rechter Kanal,
Gelb = linker Kanal.

DM 44,- 39,64

Mikrofon-Verlängerungskabel



348 031 104

TD 12, TD 16, TD 26 und TC 600 hifi über Batterieadapter
für Mono- und Stereo-Aufnahmen, Länge 10 m.
Kupplung Mak 50 S
Stecker Mas 50 S/1 = Ton (Mono
bzw. Stereo links),
4 = Ton (Stereo rechts),
2 = Masse.

DM 24,- 21,62

Ton- und Überspielleitung, Mono

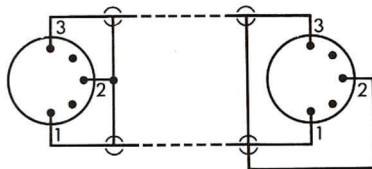

348 030 101

M 410, M 300 TS, M 302 TS,
T 105 E, Mono-Cassetten-Recorder.
Verbindung Tonband-/Tonbandgerät oder
Tonband-/Rundfunkgerät.
Länge: 1,50 m.
Stecker Mas 30 (2 x): 1 = Aufnahme,
2 = Masse,
3 = Wiedergabe.

DM 7,- 6,31

Ton- und Überspielleitung, Stereo

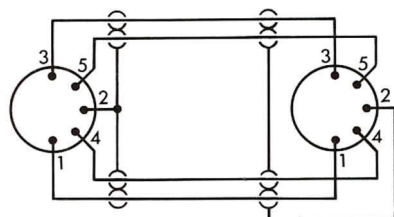



348 030 102

M 430, M 440 hifi, M 441 hifi, M 443 hifi,
M 204 TS 2 hifi, M 291 hifi, M 2000 hifi,
M 3000 hifi, M 3002 hifi, Stereo-Cassetten-Recorder.
Verbindung Tonband-/Tonbandgerät,
Tonband-/Rundfunkgerät oder Tuner/Verstärker.
Länge 1,50 m.
Stecker Mas 50 S (2 x): 1 = Aufnahme links,
4 = Aufnahme rechts,
2 = Masse,
3 = Wiedergabe links,
5 = Wiedergabe rechts.

DM 10,- 9,01

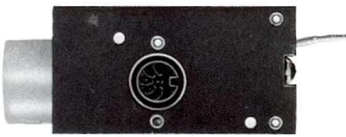

Zubehör für Tonbandgeräte

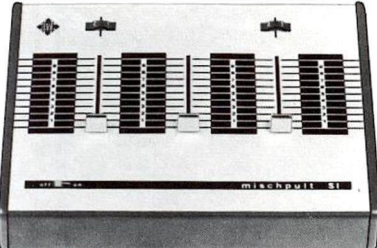
Typenbezeichnung/Abbildung	E.-Nummern	Anwendung/Ausführung	unverb. Richtpreise einschl. ohne MWSt. MWSt.
HiFi-Tonadapter FAD 4 	348 038 930	Zum Einbau in Fernsehgeräte für die Wiedergabe des Fernsehtones über HiFi-Stereo-Anlagen oder für Aufzeichnung des Fernsehtones mit Spulen-Tonbandgeräten und Cassetten-Recordern.	DM 34,- 30,63
Fernbedienung FB 3000 	348 038 951	Start/Stop-Fernbedienung mit Anzeigelampe. Anschließbar an M 2000 hifi, M 3000 hifi, M 3002 hifi.	DM 39,- 35,14
Auto-Anschlußsatz 	348 062 861	M 300 TS, M 302 TS, M cc combi K/L, M cc alpha Bestehend aus: Auto-Adapter 6/12 V (umschaltbar) für Bordnetz, auf 7,5 V Geräte-Speisespannung. Autoradio-Tonleitung für Aufnahme und Wiedergabe.	DM 45,- 40,54
mischpult Si 	348 077 783	Alle Tonbandgeräte „magnetophon“ 3kanaliges Silizium-Transistor-Mischpult (Mono). 3 Flachbahnregler (Mischen). 2 Drehregler (Pegel) Betriebsspannung 9 V. Stromversorgung durch 9 V-Flachzellen-Batterie. Ein-/Ausschalter. Frequenzbereich 40 ... 18 000 Hz. Maße (B/H/T): 25 x 19,5 x 7 cm.	DM 129,- 116,22



Zubehör für Tonbandgeräte

unverb. Richtpreise
einschl. ohne
MWSt. MWSt.

Typenbezeichnung/Abbildung	E.-Nummern	Anwendung/Ausführung	DM	7,50	6,76
Tonkopf-Reinigungsatz	348 071 302	Alle Tonbandgeräte „magnetophon“ u. T 105 E. Komplette Ausrüstung zur Reinigung von Tonköpfen und Bandführungen.			



Endlos-Bandkassette, grau	345 369 001	Alle Spulen-Tonbandgeräte „magnetophon“. Für ununterbrochene Wiederholungen von Aufnahmen. Laufzeit 16 Min. bei 9,5 cm/s. 8 Min. bei 19 cm/s.	DM	25,-	22,52
----------------------------------	--------------------	---	----	------	-------



Endlos-Bandkassette, rot	345 369 002	Anrufbeantworter T 101 zum Selbstbesprechen für Betrieb „ohne Gesprächsaufzeichnung“.	DM	25,-	22,52
---------------------------------	--------------------	---	----	------	-------



Endlos-Bandkassette, grau	345 369 004	Anrufbeantworter T 101, T 101 U, T 101 F, T 101 FG zum Selbstbesprechen für Betrieb „mit/ohne Gesprächsaufzeichnung“.	DM	25,-	22,52
----------------------------------	--------------------	--	----	------	-------

