

Für den Fachhandel

868

**Dual
Phonozubehör**

**Dual
Accessories**

**Dual
Accessoires**

Dual

Service

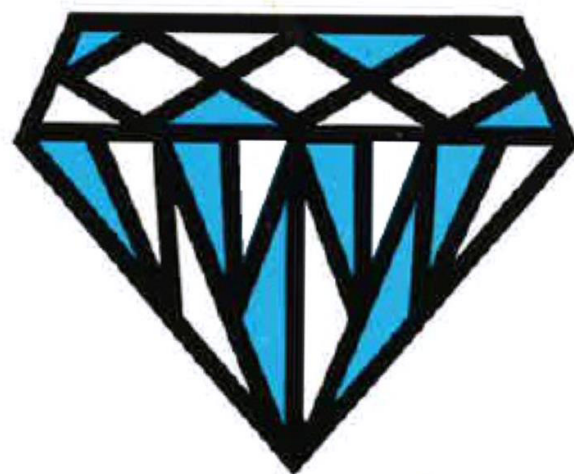



Original Dual Zubehör

bietet Gewähr für einwandfreie Wiedergabe und größtmögliche Schonung der Schallplatten.

Dual-Tonabnehmerköpfe, -Systeme und Abtastnadeln tragen den Dual-Schriftzug und sind nur in Kassetten verpackt (Abbildungen) erhältlich.

Von der Verwendung von Nachahmungen muß abgeraten werden, weil wir sonst keine Gewähr für eine störungsfreie Funktion der Geräte übernehmen können.

Genuine Dual Accessories

assure excellent sound reproduction with utmost care given to the records.

Dual pick-up heads, cartridges and styli are identified by the Dual trade-mark and are available only packed in plastic containers (illustrations).

We strongly advise not to use imitations, as in such a case, we could not assure a proper function of the units.

Les accessoires Dual d'origine

assurent la meilleure reproduction et une très grande protection des disques.

Les têtes — cellules — saphirs et diamants Dual portent l'empreinte de la marque Dual et sont toujours emballés dans de petites boîtes (fig.).

Nous déconseillons les imitations qui ne nous permettent pas de donner une garantie pour le bon fonctionnement de nos appareils.

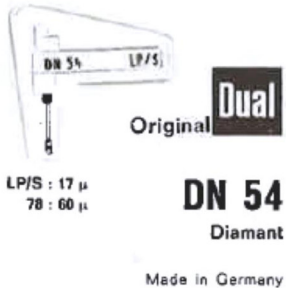

Mit dem Erscheinen dieser Liste werden die Angaben und Preise der Liste 867 und der zusätzlichen Preisliste ungültig.
This catalogue cancels 867.
Cette nomenclature annule celle portant le No. 867.

Konstruktionsänderungen sowie Liefermöglichkeit vorbehalten.
Alteration reserved. — Modifications réservées.

Die in dieser Liste aufgeführten Preise dienen zur Verrechnung mit dem Fachhandel.
Bei den mit * bezeichneten Notierungen handelt es sich um unverbindliche Richtpreise.

Dual Zubehör-Gruppenverzeichnis
Dual Accessories Catalogue
Accessoires Dual par groupes





Seite
Page
Page

Abwurfachsen etc. / Spindles, etc. / Tiges d'éjection etc.	4
Schwere Plattenteller / Heavy Turntables / Plateaux lourds	5
Tonabnehmerkabel / Pick-Up Cables / Câbles pour pick-up	6, 7
Tonarme / Tone Arms / Bras de pick-up	8, 9
Entzerrer-Vorverstärker / Equalizer preamplifier / Préamplificateur de correction	11
1019, 1016, 1015/F, 1009 SK / SK 2 / F	10, 11
1019, 1016, 1015/F, 1009 SK / SK 2 / F	12, 13
1019, 1016, 1015/F, 1009 SK / SK 2 / F	14, 15
1009	16, 17
1010 F, 1010 S, 1010 A	18, 19
Tonabnehmerelemente für Pick-Up assemblies for Eléments du pick-up pour	20, 21
1011, 1010, 1008 A, 1007 A	22, 23
1008, 1007	24, 25
1006 A, 1006, 1006 AM, 1006 M	26, 27
1004 S, 1004 D	28, 29
1005, 1004, 1003	30, 31
1002 F, 1002 E, 1002 D, 1002, 275, 270	32, 33
412, 410, 410 B, 400, 400 B	34, 35
300 A, 300 B	36, 37
300, 295	38, 39
Konsolen / Bases / Supports	40
Antriebsrollen / Motor Pulleys / Galets d'entraînement	41
Service-Ausrüstung / Service Equipment / Matériel pour service après vente	42
Werkvertretungen	43
Kundendienststellen	

⊗ = Stereo-Tonabnehmersysteme
Stereo Pick-Up Cartridges
Cellules de pick-up stéréo

○ = Monaurale Tonabnehmersysteme
Monaural Pick-Up Cartridges
Cellules de pick-up monaurales

Die in den Preisspalten aufgeführten Buchstaben dienen zur Kennzeichnung der Warengruppen.

Geräte-Type Model Appareil	Abbildung und Type Illustration and type Figure et type	B.-No.	Preis je Stück ohne MwSt. DM
1006/M 1006 A/M 1007/A 1008/A 1009/SK/SK 2/F 1010/A/S/F 1011 1015/F 1016 1019	 Abwurfsäule AS 9 Automatic Changer Spindle AS 9 Tige d'éjection AS 9	13 E - Ausf. A 202 357	12.50* A
1003 1004 1004 D 1004 S 1005	 Wechselachse AW 1 Changing Spindle AW 1 Axe changeur AW 1	12 A - U 184 206 676	6.80 E
1006/M 1006 A/M 1007/A 1008/A 1009/SK/SK 2/F 1010/A/S/F 1011 1015/F 1016 1019	 Wechselachse AW 2 Changing Spindle AW 2 Axe changeur AW 2	12 C - U 208 200 469	13.70 E
1003 1004 1004 S 1005 1006/A 1007/A 1008/A 1009 1010/A/S/F 1011 1015/F	 Plattenstift / Spindle / Axe	12 F - 246 200 709	—,70 E

Geräte-Type Model Appareil	Abbildung und Type Illustration and type Figure et type	B.-No.	Preis je Stück ohne MwSt. DM
1009 SK 1009 SK 2 1009 F 1016 1019	 Mitlaufstift Single play spindle Tige centrale	12 K - U 337 201 101	2.70 E
nach Bedarf when required suivant les besoins	 Zentrierstück / Adapter / Centreur	12 K - U 327 201 095	—,55 E
	 Halter für Plattenstift, Wechselachse und Zentrierstück Holder for spindle, changing spindle and adapter Support pour axe, axe changeur et centreur	13 F - U 4 202 371	—,60 E
1006 1007 1007 A 1008 1008 A	 Schwere Plattenteller Heavy Turntables / Plateaux lourds	12 C - U 221 206 940 12 D - U 150 207 096 12 D - U 42 207 115 12 F 2 ^e	 In order to achieve stereo sound la reproduction du deuxième canal

Tonabnehmerkabel / Pick-Up Cables

Câbles pour pick-up

Geräte-Type Model Appareil	Abbildung und Type Illustration and type Figure et type	B.-No.	Preis je Stück ohne MwSt. DM
		12 F - U 133 207 303	5.30 E
		12 K - U 350 213 833	7.— E
		12 D - U 176 207 102	4.60 E
		12 F - U 131 207 301	5.50 E
nach Bedarf		12 F - U 127 207 299	6.50 E
when required		37 A - U 12 205 255	5.90 E
suivant les besoins		37 Z - U 23 205 344	9.—* C
		12 D - 440 207 187	1.50/m E

Geräte-Type Model Appareil	Abbildung und Type Illustration and type Figure et type	B.-No.	Preis je Stück ohne MwSt. DM
300 AV 300 V 300 VX 300 TV 22 1004 SV 1004 SV 20 1007 V 1007 TV 23 1008 V 24 1008 AV 26		25 B - U 14 207 928	7.50 E
		25 B - U 16 207 929	6.50 E
300 AV/1 400 V H 400 V 410 V H 410 V 410 V/1 H 410 V/1 P 50 H 50 1007 V/1 1007 AV 1010 V H 1010 V 1010 AV H 1010 AV 1010 SV H 1010 SV P 52 H 52		25 S - U 20 ** 203 431	6.50 E
		25 S - U 24 208 028	7.50 E
		26 H - U 16 208 091	7.50 E
		26 H - U 18 208 093	8.40 E
TVV 42/43/46 1008 AV 26 1011 V 26 P 41 HS 11 HS 20 HS 21 HS 31 HS 32		26 M - U 17 203 634	6.50 E
HS 10 1010 AV 52		29 F - U 32 204 195	4.70 E

zur Verbindung von Tonabnehmerkern und monauralen
Tunern und Funkgeräten
connection of amplifier
tuners or radios
pour le raccordement des
des tuners ou des radios amplificateurs et

Lautsprecher-Anschlußkabel
Loudspeaker cable
Câble de haut-parleur

2-Kanal-Tonabnehmerkabel als Meter
2-channel pick-up cable — per meter
au mètre, à deux canaux pour pick-up

l = linker Kanal
left channel
canal de gauche

⊥ = Masse
mass
masse



Kabel zum Anschluß monauraler oder 2-kanaliger Verstärkeranlagen, Rundfunk- oder Tonbandgeräte
Cables for connecting monaural or 2-channel amplifiers, tuners, radios or tape recorders
Câbles pour raccorder aux amplificateurs mono ou à deux canaux, aux radios ou aux enregistreurs

** nur für den Anschluß eines separaten Verstärkers für die Wiedergabe des 2. Kanals
zur Erzielung des Stereoeffektes
** only for connection of separate amplifier for reproduction of second channel in order to achieve stereo sound
** destiné seulement au branchement d'un amplificateur séparé pour la reproduction du deuxième canal
pour obtenir l'effet stéréo

Geräte-Type Model Appareil	Abbildung Illustration Figure	B.-No.	Preis je Stück ohne MwSt. DM
300 A 300 B		15 K - U 11 207 779	5.50 E
400 400 B		11 K - U 101 206 548	7.30 E
410 410 B 412		11 M - U 177 200 266	7.70 E
1003 1005		15 B - U 4 207 617	10.— E
1004 1004 D 1004 S 1004 SD		15 D - U 18 207 644	11.80 E
1006 1006 M 1006 A 1006 AM		15 E - U 55 207 674 15 E - U 330 207 686	17.70 E
1007 1008		15 J - U 4 207 777	7.30 E

Geräte-Type Model Appareil	Abbildung Illustration Figure	B.-No.	Preis je Stück ohne MwSt. DM
1007 A 1008 A		15 M - U 1 207 815	7.70 E
1009		15 N - U 23 207 826	20.— E
1010 1011		15 P - U 3 207 842	11.80 E
1010 A 1010 S 1010 F		12 R - U 51 202 067	12.70 E
1009 F 1009 SK 1009 SK 2 1016		12 J - U 103 207 420	18.20 E
1015 1015 F		12 P - U 103 207 503	20.— E
1019		12 K - U 305 201 082	22.80 E

HIFI Plattenspieler Dual 1019, 1016, 1015/F, 1009 SK/SK2/F

Tonabnehmerköpfe komplett Pick-Up Heads Complete Têtes de lecture complètes	Verwendungszweck Kenndaten Application Data Utilisation Données caractéristiques	B.-No.	Preis je Stück ohne MwSt. DM	Köpfe ohne System Heads without Cartridges Têtes sans cellule B.-No.	Preis je Stück ohne MwSt. DM
	Mikrorillen- und Stereo-Schallplatten Auflagekraft 1-1,5 p Micro-groove and stereo records Tracking weight 1-1,5 p Disques micro et stéréo . Force d'appui 1-1,5 p	14 L - U 115 202 595	145.50	TK 12 12 K - U 280 213 836	5.50
	Mikrorillen- und Stereo-Schallplatten Auflagekraft 1,25-1,75 p Micro-groove and stereo records Tracking weight 1.25-1.75 p Disques micro et stéréo . Force d'appui 1,25-1,75 p	14 L - U 118 213 515	131.—	TK 12 12 K - U 280 213 836	5.50
	Mikrorillen- und Stereo-Schallplatten Auflagekraft 2-3 p Micro-groove and stereo records Tracking weight 2-3 p Disques micro et stéréo . Force d'appui 2-3 p	14 L - U 119 213 517	89.—	TK 12 12 K - U 280 213 836	5.50

Spezial-Abtastnadel / Special stylus / Pointe de lecture spéciale
für / for / pour Shure M 75 M-G / M 73 M-G / M 71 M-B

	für Normal rillen-Schallplatten Auflagekraft 3 p for normal groove (78 rpm) records. Tracking weight 3 p pour disques normaux . Force d'appui 3 p	14 G - U 512 202 440	55.50	grün green vert	G
--	---	-----------------------------	--------------	-----------------------	---

Weitere Tonabnehmerköpfe für 1019, 1016, 1015/F, 1009 SK/SK2/F siehe Seite 12/13/14/15
Autre têtes de lecture pour 1019, 1016, 1015/F, 1009 SK/SK2/F voir page 12/13/14/15

HiFi Turntable Dual 1019, 1016, 1015/F, 1009 SK/SK2/F
HiFi Tourne-disques Dual 1019, 1016, 1015/F, 1009 SK/SK2/F

Tonabnehmersysteme mit Abtastnadeln Pick-up Cartridges with Styli Cellules de pick-up avec pointes de lecture	B.-No.	Preis je Stück ohne MwSt. DM	Diamant-Abtastnadeln Diamond Styli Pointes de lecture diamant	B.-No.	Preis je Stück ohne MwSt. DM
	14 G - U 311 202 433	140.—	DN 320  M-Diamant = 15 µ M-Diamond = 0.6 mil	14 G - U 511 207 570	71.—
Stereo-Magnetsystem Magnetic stereo cartridge Cellule magnétique stéréo		E		grau grey gris	G
	14 G - U 316 212 784	125.50	DN 323  M-Diamant = 15 µ M-Diamond = 0.6 mil	14 G - U 513 212 789	63.60
Stereo-Magnetsystem Magnetic stereo cartridge Cellule magnétique stéréo		E		grau grey gris	G
	14 G - U 317 212 787	83.50	DN 325  M-Diamant = 15 µ M-Diamond = 0.6 mil	14 G - U 515 212 791	41.80
Stereo-Magnetsystem Magnetic stereo cartridge Cellule magnétique stéréo		E		beige	G

Hi-Fi-Entzerrer-Vorverstärker / Hi-Fi-Equalizer preamplifier / Hi-Fi-Préamplificateur de correction



	Zum Anschluß von Phonogeräten mit Magnetsystem an Verstärker ohne entsprechenden Eingang For connecting phono-units with magnetic cartridge to amplifiers without corresponding input Pour raccorder des appareils phonographiques avec une cellule magnétique aux amplificateurs sans entrée spéciale	34 F - Ausf. A 204 831	64.—*	D
---	--	-------------------------------	--------------	---

Additional pick-up heads for 1019, 1016, 1015/F, 1009 SK/SK2/F see page 12/13/14/15

HiFi Plattenspieler Dual 1019, 1016, 1015/F, 1009 SK/SK2/F









Tonabnehmerköpfe komplett Pick-Up Heads Complete Têtes de lecture complètes	Verwendungszweck Kenndaten Application Data Utilisation Données caractéristiques	B.-No.	Preis je Stück ohne MwSt. DM	Köpfe ohne System Heads without Cartridges Têtes sans cellule B.-No.	Preis je Stück ohne MwSt. DM
 TK 111	Mikrorillen- und Stereo-Schallplatten Auflagekraft 1,5 p Micro-groove and stereo records Tracking weight 1.5 p Disques micro et stéréo . Force d'appui 1,5 p	14 L - U 102 202 589	131.— E	TK 12 12 K - U 280 213 836	5.50 E
 TK 132	Mikrorillen- und Stereo-Schallplatten Auflagekraft 1,5 p Micro-groove and stereo records Tracking weight 1.5 p Disques micro et stéréo . Force d'appui 1,5 p	14 L - U 109 202 594	131.80 E	TK 12 12 K - U 280 213 836	5.50 E
 TK 131	Mikrorillen- und Stereo-Schallplatten Auflagekraft 2,5-3 p Micro-groove and stereo records Tracking weight 2,5-3 p Disques micro et stéréo . Force d'appui 2,5-3 p	14 L - U 108 202 593	89.— E	TK 12 12 K - U 280 213 836	5.50 E

Spezial-Abtastnadeln / Special styl
für / for / pour Shure M 44 M-G
für / for / pour Pickering

 DN 306 N-Diamant = 65 µ N-Diamond = 2.7 mil	für Normalrillen-Schallplatten Auflagekraft 3 p für normal groove (78 rpm) records . Tracking weight 3 p pour disques normaux . Force d'appui 3 p	14 G - U 122 202 429 grün green vert	51.— G	DN 314  N-Diamant = 65 µ N-Diamond = 2.7 mil
---	---	--	---------------	---

Entzerrer-Vorverstärker TVV 46 siehe Seite 11 / Equalizer preamplifier see page 11

HiFi Turntable Dual 1019, 1016, 1015/F, 1009 SK/SK2/F
HiFi Tourne-disques Dual 1019, 1016, 1015/F, 1009 SK/SK2/F



Tonabnehmersysteme mit Abtastnadeln Pick-Up Cartridges with Styl Cellules de pick-up avec pointes de lecture	B.-No.	Preis je Stück ohne MwSt. DM	Diamant-Abtastnadeln Diamond Styl Pointes de lecture diamant	B.-No.	Preis je Stück ohne MwSt. DM
 Shure M 44 M-G  Stereo-Magnetsystem Magnetic stereo cartridge Cellule magnétique stéréo	14 G - U 49 202 423	125.50 E	DN 305  M-Diamant = 16 µ M-Diamond = 0.7 mil	14 G - U 120 202 427 grau grey gris	63.60 G
 Pickering V 15/PD 1  Stereo-Magnetsystem Magnetic stereo cartridge Cellule magnétique stéréo	14 G - U 305 202 432	126.30 E	DN 315  M-Diamant = 15 µ M-Diamond = 0.6 mil	14 G - U 505 202 439 schwarz black noir	65.50 G
 Pickering V 15/DAC  Stereo-Magnetsystem Magnetic stereo cartridge Cellule magnétique stéréo	14 G - U 301 202 431	83.50 E	DN 311  M-Diamant = 17 µ M-Diamond = 0.7 mil	14 G - U 501 202 437 grau grey gris	41.80 G

Pointes de lecture spéciales

für Normalrillen-Schallplatten Auflagekraft 3 p for normal groove (78 rpm) records . Tracking weight 3 p pour disques normaux . Force d'appui 3 p	14 G - U 502 202 438 blau blue bleu	38.20 G	Weitere Tonabnehmerköpfe für 1019, 1016, 1015/F, 1009 SK/SK2/F siehe Seite 10/11/14/15 Additional pick-up heads for 1019, 1016, 1015/F, 1009 SK/SK2/F see page 10/11/14/15 Autre têtes de lecture pour 1019, 1016, 1015/F, 1009 SK/SK2/F voir page 10/11/14/15
---	---	----------------	---

Préamplificateur de correction voir page 11

HiFi Plattenspieler Dual 1019, 1016, 1015/F, 1009 SK/SK2/F

Tonabnehmerköpfe komplett Pick-Up Heads Complete Têtes de lecture complètes	Verwendungszweck Kenndaten Application Data Utilisation Données caractéristiques	B.-No.	Preis Je Stück ohne MwSt. DM	Köpfe ohne System Heads without Cartridges Têtes sans cellule B.-No.	Preis je Stück ohne MwSt. DM
	Mikrorillen- und Stereo-Schallplatten Auflagekraft 2-3 p Micro-groove and stereo records Tracking weight 2-3 p Disques micro et stéréo. Force d'appui 2-3 p	14 L - U 104 202 591	77.30 E	TK 12 12 K - U 280 213 836	5.50 E
	Mikrorillen- und Stereo-Schallplatten Auflagekraft 3,5-4,5 p Micro-groove and stereo records Tracking weight 3,5-4,5 p Disques micro et stéréo. Force d'appui 3,5-4,5 p	14 L - U 103 202 590	26.50 E	TK 12 12 K - U 280 213 836	5.50 E

Spezial-Abtastnadeln / Special styli

für / for / pour Sp 1

	für Normalrillen-Schallplatten Auflagekraft 3 p for normal groove (78 rpm) records . Tracking weight 3 p pour disques normaux Force d'appui 3 p	14 G - U 69 207 568	25.50 grün green vert	25.50 G
--	--	------------------------	------------------------------------	----------------





Weitere Tonabnehmerköpfe für 1019, 1016, 1015/F, 1009 SK/SK2/F siehe Seite 10/11/12/13

Additional pick-up heads for 1019, 1016, 1015/F, 1009 SK/SK2/F see page 10/11/12/13



Autre têtes de lecture pour 1019, 1016, 1015/F, 1009 SK/SK2/F voir page 10/11/12/13

Entzerrer-Vorverstärker TVV 46 siehe Seite 11 / Equalizer preamplifier see page 11

HiFi Turntable Dual 1019, 1016, 1015/F, 1009 SK/SK2/F
HiFi Tourne-disques Dual 1019, 1016, 1015/F, 1009 SK/SK2/F



Tonabnehmersysteme mit Abtastnadeln Pick-Up Cartridges with Styli Cellules de pick-up avec pointes de lecture	B.-No.	Preis Je Stück ohne MwSt. DM	Saphir- und Diamant-Abtastnadeln Sapphire and Diamond Styli Pointes de lecture saphir et diamant	B.-No.	Preis je Stück ohne MwSt. DM
B & O Sp 1 	14 G - U 47 202 422	71.80 E	DN 301 	14 G - U 67 207 569	32.80 G
Stereo-Magnetsystem Magnetic stereo cartridge Cellule magnétique stéréo			M-Diamant = 16 µ M-Diamond = 0.7 mil	blau blue bleu	
CDS 630/5 	14 K - U 342 202 521	21.— E	DN 5 	14 K - U 502 202 529	7.30 G
Stereo-Kristallsystem Crystal stereo cartridge Cellule piezo stéréo			M-Saphir = 17 µ M-Sapphire = 0.7 mil N-Saphir = 60 µ N-Sapphire = 2.4 mil		

Pointes de lecture spéciales
für / for / pour CDS 630

DN 54 	für Normal-, Mikrorillen- und Stereo-Schallplatten for normal (78 rpm)-, micro-groove and stereo records pour disques normaux, micro et stéréo	14 K - U 506 202 531	24.50 G
DN 52 	für Mikrorillen- und Stereo-Schallplatten for micro-groove and stereo records pour disques micro et stéréo	14 K - U 504 202 530	7.30 G
M 1 - Saphir = 17 µ M 1 - Sapphire = 0.7 mil M 2 - Saphir = 23 µ M 2 - Sapphire = 1 mil			

Préamplificateur de correction voir page 11



HiFi Plattenspieler Dual 1009 / HiFi Turntable Dual 1009

Tonabnehmerköpfe komplett Pick-Up Heads Complete Têtes de lecture complètes	Verwendungszweck Kenndaten Application Data Utilisation Données caractéristiques	B.-No.	Preis je Stück ohne MwSt. DM	Köpfe ohne System Heads without Cartridges Têtes sans cellule B.-No.	Preis je Stück ohne MwSt. DM
	O 96 Mikrorillen- und Stereo-Schallplatten Auflagekraft 1,5 p Micro- groove and stereo records Tracking weight 1.5 p Disques micro et stéréo. Force d'appui 1,5 p	14 J - U 138 207 588	129.20 E	O 12 b 15 L - U 29 207 793	3.70 E
	O 95 Mikrorillen- und Stereo-Schallplatten Auflagekraft 2-3 p Micro- groove and stereo records Tracking weight 2-3 p Disques micro et stéréo. Force d'appui 2-3 p	14 J - U 137 207 589	75.50 E	O 12 b 15 L - U 29 207 793	3.70 E
	O 212 Normal-, Mikrorillen- und Stereo-Schallplatten Auflagekraft 3,5-4,5 p Normal (78 rpm)-, micro-groove and stereo records Tracking weight 3,5-4,5 p Disques normaux, micro et stéréo Force d'appui 3,5-4,5 p	14 K - U 102 207 600	24.70 E	O 12 b 15 L - U 29 207 793	3.70 E

Spezial-Abtastnadeln / Special styli









für / for / pour Shure M 44 M-G

für / for / pour Sp 1

	DN 306 für Normalrillen- Schallplatten Auflagekraft 3 p for normal groove (78 rpm) records Tracking weight 3 p pour disques normaux Force d'appui 3 p	14 G - U 122 202 429	51.— G	DN 302  N-Diamant = 70 µ N-Diamond = 3 mil
--	--	-------------------------	---------------	---

Entzerrer-Vorverstärker TVV 46 siehe Seite 11 / Equalizer preamplifier see page 11

HiFi Tourne-disques Dual 1009

Tonabnehmersysteme mit Abtastnadeln Pick-Up Cartridges with Styli Cellules de pick-up avec pointes de lecture	B.-No.	Preis je Stück ohne MwSt. DM	Saphir- und Diamant- Abtastnadeln Sapphire and Diamond Styli Pointes de lecture saphir et diamant	B.-No.	Preis je Stück ohne MwSt. DM
	Shure M 44 M-G 	14 G - U 49 202 423	125.50 E	DN 305  M-Diamant = 16 µ M-Diamond = 0.7 mil	14 G - U 120 202 427 grau grey gris G
	B & O Sp 1 	14 G - U 47 202 422	71.80 E	DN 301  M-Diamant = 16 µ M-Diamond = 0.7 mil	14 G - U 67 207 569 blau blue bleu G
	CDS 630/5 	14 K - U 342 202 521	21.— E	DN 5  M-Saphir = 17 µ M-Sapphire = 0.7 mil N-Saphir = 80 µ N-Sapphire = 2.4 mil	14 K - U 502 202 529 G



Pointes de lectures spéciales

für / for / pour CDS 630

	DN 506 für Normalrillen- Schallplatten Auflagekraft 3 p for normal groove (78 rpm) records. Tracking weight 3 p pour disques normaux. Force d'appui 3 p	14 G - U 69 207 568	25.50 G	DN 54  M-Diamant = 17 µ M-Diamond = 0.7 mil N-Saphir = 60 µ N-Sapphire = 2.4 mil	14 K - U 506 202 531 für Normal-, Mikrorillen- und Stereo-Schallplatten for normal (78 rpm) micro-groove and stereo records pour disques normaux, micro et stéréo	24.50 G
---	--	------------------------	-----------------------	---	--	-----------------------

Préamplificateur de correction voir page 11



Plattenwechsler Dual 1010 F, 1010 S, 1010 A / Record Changer

Tonabnehmerköpfe komplett Pick-Up Heads Complete Têtes de lecture complètes	Verwendungszweck Kenndaten Application Data Utilisation Données caractéristiques	B.-No.	Preis je Stück ohne MwSt. DM	Köpfe ohne System Heads without Cartridges Têtes sans cellule B.-No.	Preis je Stück ohne MwSt. DM
TK 151 	Normal-, Mikrorillen- und Stereo-Schallplatten Auflagekraft 3,5-4,5 p Normal (78 rpm)-, micro-groove and stereo records Tracking weight 3.5-4.5 p Disques normaux, micro et stéréo Force d'appui 3,5-4,5 p	14 L - U 103 202 590	26.50 E	TK 12 12 K - U 280 213 836	5.50 E
TK 152 	Normal-, Mikrorillen- und Stereo-Schallplatten Auflagekraft 3,5-4,5 p Normal (78 rpm)-, micro-groove and stereo records Tracking weight 3.5-4.5 p Disques normaux, micro et stéréo Force d'appui 3,5-4,5 p	14 L - U 105 202 592	43.70 E	TK 12 12 K - U 280 213 836	5.50 E

Spezial-Abtastnadeln für TA-System CDS 630 / Special styli for pick-up cartridge CDS 630

DN 54 	für Normal-, Mikrorillen- und Stereo-Schallplatten for normal (78 rpm)-, micro- groove and stereo records pour disques normaux, micro et stéréo	14 K - U 506 202 531	24.50 G
---	--	-----------------------------	------------------------



Dual 1010 F, 1010 S, 1010 A / Changeur de disques Dual 1010 F, 1010 S, 1010 A

Kristallsysteme mit Abtastnadeln Crystal Pick-Up Cartridges with Stylil Cellules piezo avec pointes de lecture	B.-No.	Preis je Stück ohne MwSt. DM	Saphir- und Diamant- Abtastnadeln Sapphire and Diamond Styli Pointes de lecture saphir et diamant	B.-No. Kennfarbe Color Code Couleur	Preis je Stück ohne MwSt. DM
CDS 630/5 	14 K - U 342 202 521	21.— E	DN 5  M-Saphir = 17 µ M-Sapphire = 0.7 mil N-Saphir = 60 µ N-Sapphire = 2.4 mil	14 K - U 502 202 529	7.30 G
CDS 630/54 	14 K - U 346 202 524	38.20 E	DN 54  M-Diamant = 17 µ M-Diamond = 0.7 mil N-Saphir = 60 µ N-Sapphire = 2.4 mil	14 K - U 506 202 531	24.50 G

Pointes spéciales pour cellule CDS 630



DN 52 	für Mikrorillen- und Stereo- Schallplatten for micro- groove and stereo records pour disques micro et stéréo	14 K - U 504 202 530	7.30 G
--	---	-----------------------------	-----------------------

Plattenwechsler Dual 1011, 1010, 1008 A, 1007 A / Record Changer Dual 1011,





Tonabnehmerköpfe komplett Pick-Up Heads Complete Têtes de lecture complètes	Verwendungszweck Kenndaten Application Data Utilisation Données caractéristiques	B.-No.	Preis je Stück ohne MwSt. DM	Köpfe ohne System Heads without Cartridges Têtes sans cellule B.-No.	Preis je Stück ohne MwSt. DM
O 1 b 	Nicht mehr lieferbar / Ersetzt durch: TA-Kopf O 212 No longer available / Replaced by: Pick-up head O 212 Epuisé / Remplacée par tête O 212				
O 212 	Normal-, Mikrorillen- und Stereo-Schallplatten Auflagekraft 5,5-6,5 p Normal (78 rpm)- micro-groove and stereo records Tracking weight 5.5-6.5 p Disques normaux, micro et stéréo Force d'appui 5,5-6,5 p	14 K - U 102 207 600	24.70 E	O 12 b 15 L - U 29 207 793	3.70 E

Spezial-Abtastnadeln / Special styli

für / for / pour CDS 620



DN 42  M-Saphir = 23 µ M-Sapphire = 1 mil	für Mikrorillen- Schallplatten for micro-groove records pour disques micro	14 E - U 65 207 552	4.20 G	grün/blau green/blue vert/bleu
DN 43  M-Diamant = 17 µ M-Diamond = 0.7 mil	für Mikrorillen- und Stereo- Schallplatten for micro- groove and stereo records pour disques micro et stéréo	14 E - U 63 207 555	21.80 G	grün/gold green/gold vert/or

1010, 1008 A, 1007 A / Changeur de disques Dual 1011, 1010, 1008 A, 1007 A

Kristallsysteme mit Abtastnadeln Crystal Pick-Up Cartridges with Stylil Cellules piezo avec pointes de lecture	B.-No.	Preis je Stück ohne MwSt. DM	Saphir-Abtastnadeln Sapphire Styli Pointes de lecture saphir	B.-No.	Preis je Stück ohne MwSt. DM
CDS 620/4/45 	Nicht mehr lieferbar No longer available Epuisé		DN 4  M-Saphir = 17 µ M-Sapphire = 0.7 mil	14 E - U 62 207 553 grün green vert	4.20 G
CDS 630/5 	14 K - U 342 202 521	21.— E	DN 45 N-Saphir = 60 µ N-Sapphire = 2.4 mil	14 E - U 64 207 554 grün/rot green/red vert/rouge	4.20 G
			DN 5  M-Saphir = 17 µ M-Sapphire = 0.7 mil N-Saphir = 60 µ N-Sapphire = 2.4 mil	14 K - U 502 202 529	7.30 G

Pointes de lecture spéciales



für / for / pour CDS 630

DN 52  M-Saphir = 17 µ M-Sapphire = 0.7 mil M-Saphir = 23 µ M-Sapphire = 1 mil	für Mikrorillen- und Stereo- Schallplatten for micro- groove and stereo records pour disques micro et stéréo	14 K - U 504 202 530	7.30 G
DN 54  M-Diamant = 17 µ M-Diamond = 0.7 mil N-Saphir = 60 µ N-Sapphire = 2.4 mil	für Normal-, Mikrorillen- und Stereo-Schallplatten for normal (78 rpm)-, micro- groove and stereo records pour disques normaux, micro et stéréo	14 K - U 506 202 531	24.50 G





Plattenwechsler Dual 1008, 1007 / Record Changer Dual 1008, 1007

	Verwendungszweck Kenndaten Application Data Utilisation Données caractéristiques	
	Normal-, Mikrorillen- und Stereo-Schallplatten Auflagekraft 5,5 p	Tonabnehmerkopf ist vom Gerät nicht abnehmbar
	Normal (78 rpm)-, micro-groove and stereo records Tracking weight 5.5 p	The pick-up head is not removable from the unit
	Disques normaux- micro et stéréo Force d'appui 5,5 p	La tête de lecture ne peut pas être séparée de l'appareil



Spezial-Abtastnadeln für TA-System CDS 520 / Special styli for pick-up cartridge CDS 520

DN 23  M-Diamant = 17 µ M-Diamond = 0.7 mil	für Mikrorillen- und Stereo-Schallplatten for micro-groove and stereo records pour disques micro et stéréo	14 A - U 43 207 513 gold gold or	21.80 G
DN 26  M-Saphir = 17 µ M-Sapphire = 0.7 mil	für Mikrorillen- und Stereo- Schallplatten for micro-groove and stereo records pour disques micro et stéréo	14 A - U 48 207 512 rot red rouge	4.20 G

Changeur de disques Dual 1008, 1007

Kristallsysteme mit Abtastnadeln Crystal Pick-up Cartridges with Styli Cellules piezo avec pointes de lecture	B.-No. Kennfarbe Color Code Couleur	Preis je Stück ohne MwSt. DM	Saphir- und Diamant- Abtastnadeln Sapphire and Diamond Styli Pointes de lecture saphir et diamant	B.-No. Kennfarbe Color Code Couleur	Preis je Stück ohne MwSt. DM
CDS 520/3 	14 F - U 42 207 562 weiß white blanc	18.20 E	DN 3  N M N-Saphir = 60 µ N-Sapphire = 2.4 mil M-Saphir = 17 µ M-Sapphire = 0.7 mil	14 D - U 62 207 542 braun brown brun	5.40 G
CDS 520/34 	14 F - U 44 207 563 weiß white blanc	36.— E	DN 34  N M N-Saphir = 60 µ N-Sapphire = 2.4 mil M-Diamant = 17 µ M-Diamond = 0.7 mil	14 D - U 66 207 541 silber/braun silver/brown argent/brun	23.20 G

Pointes spéciales pour cellule CDS 520

DN 32  M2 M1 M 1 - Saphir = 17 µ M 1 - Sapphire = 0.7 mil M 2 - Saphir = 23 µ M 2 - Sapphire = 1 mil	für Mikrorillen- (M 2) und Stereo-Schallplatten (M 1) for micro- groove (M 2) and stereo records (M 1) pour disques micro (M 2) et stéréo (M 1)	14 D - U 64 207 540 rot red rouge	5.40 G
DN 34  N M N-Saphir = 60 µ N-Sapphire = 2.4 mil M-Diamant = 17 µ M-Diamond = 0.7 mil	für Normal-, Mikrorillen- und Stereo-Schallplatten for normal (78 rpm)-, micro- groove and stereo records pour disques normaux, micro et stéréo	14 D - U 66 207 541 silber/braun silver/brown argent/brun	23.20 G

Plattenwechsler Dual 1006 A, 1006 / Record Changer Dual 1006 A,



Tonabnehmereinsätze komplett Pick-Up Cartridge Inserts complete Ensembles de lecture complets	Verwendungszweck Kenndaten Application Data Utilisation Données caractéristiques	B.-No.	Preis je Stück ohne MwSt. DM	Halterung ohne System Mounting Plate without Cartridge Monture sans cellule B.-No.	Preis je Stück ohne MwSt. DM
	Mikrorillen- und Stereo-Schallplatten Auflagekraft 5,5 p Micro-groove and stereo records Tracking weight 5.5 p Disques micro et stéréo . Force d'appui 5,5 p	14 E - U 1 207 557	17.70	15 E - U 86 207 683	—,90 E

Plattenwechsler Dual 1006 AM, 1006 M / Record Changer Dual

	Nicht mehr lieferbar / Ersetzt durch: Tonabnehmereinsatz LM33/Sp 1 No longer available / Replaced by: Pick-Up Cartridge Insert LM33/Sp 1 Epuisé / Remplacée par ensemble de lecture LM 33 / Sp 1				
LM 33 / Sp 1	Mikrorillen- und Stereo-Schallplatten Auflagekraft 4,5 p Micro-groove and stereo records Tracking weight 4.5 p Disques micro et stéréo Force d'appui 4,5 p	14 G - U 17 202 496	72.70	15 E - U 87 207 684	—,90 E



Spezial-Abtastnadeln / Special styli

für / for / pour DMS 900



	14 G - U 64 207 576	9.10			14 G - U 65 207 575	9.10
für Mikrorillen-Schallplatten for micro-groove records pour disques micro M-Saphir = 23 µ M-Sapphire = 1 mil	rot red rouge	G		für Normalrillen-Schallplatten for normal groove (78 rpm) records pour disques normaux N-Saphir = 60 µ N-Sapphire = 2.4 mil	blau blue bleu	G

Entzerrer-Vorverstärker TVV 46 siehe Seite 11 / Equalizer preamplifier see page 11

1006 / Changeur de disques 1006 A, 1006



Tonabnehmersysteme mit Abtastnadeln Pick-Up Cartridges with Stylil Cellules avec pointes de lecture	B.-No.	Preis je Stück ohne MwSt. DM	Saphir- und Diamant-Abtastnadeln Sapphire and Diamond Styli Pointes de lecture saphir et diamant	B.-No. Kennfarbe Color Code Couleur	Preis je Stück ohne MwSt. DM	
	CDS 420/4	14 E - U 42 207 556	16.80	DN 4  M-Saphir = 17 µ M-Sapphire = 0.7 mil	14 E - U 62 207 553 grün green vert	4.20 G

1006 AM, 1006 M / Changeur de disques Dual 1006 AM, 1006 M

	DMS 900/96			DN 96 M-Diamant = 17 µ M-Diamond = 0.7 mil	14 G - U 68 207 573 rot red rouge	27.30 G
B & O Sp 1		14 G - U 47 202 422	71.80	DN 301 M-Diamant = 16 µ M-Diamond = 0.7 mil	14 G - U 67 207 569 blau blue bleu	32.80 G



Pointes de lecture spéciales

für / for / pour CDS 420

	14 E - U 63 207 555	21.80			14 E - U 64 207 554	4.20
für Mikrorillen- und Stereo-Schallplatten for micro-groove and stereo records pour disques micro et stéréo M-Diamant = 17 µ M-Diamond = 0.7 mil	grün/gold green/gold vert/or	G		für Normalrillen-Schallplatten for normal groove (78 rpm) records pour disques normaux N-Saphir = 60 µ N-Sapphire = 2.4 mil	grün/rot green/red vert/rouge	G

Préamplifier de correction voir page 11

Plattenwechsler Dual 1004 S, 1004 D / Record Changer Dual 1004 S,

Tonabnehmerköpfe komplett Pick-Up Heads Complete Têtes de lecture complètes	Verwendungszweck Kenndaten Application Data Utilisation Données caractéristiques	B.-No.	Preis je Stück ohne MwSt. DM	Köpfe ohne System Heads without Cartridges Têtes sans cellule B.-No.	Preis je Stück ohne MwSt. DM
KS 2 	Normal-, Mikrorillen- und Stereo-Schallplatten Auflagekraft 5,5 p Normal (78 rpm)-, micro-groove and stereo records Tracking weight 5.5 p Disques normaux micro et stéréo Force d'appui 5,5 p	14 D - U 2 207 543	24.— E	14 D - U 22 207 547	5.80 E
K 	Normal- und Mikrorillen- Schallplatten Auflagekraft 9 p Normal (78 rpm)-, and micro- groove records Tracking weight 9 p Disques normaux et micro. Force d'appui 9 p	14 C - U 70 207 530	19.— E	14 C - U 80 207 531	5.80 E

Spezial-Abtastnadeln / Special styli

für / for / pour CDS 320



DN 32  M 2 M 1 M 1 - Saphir = 17 µ M 1 - Sapphire = 0.7 mil M 2 - Saphir = 23 µ M 2 - Sapphire = 1 mil	für Mikrorillen- und Stereo- Schallplatten for micro-groove and stereo records pour disques micro et stéréo	14 D - U 64 207 540	5.40 rot red rouge	5.40 G
DN 34  N M N-Saphir = 60 µ N-Sapphire = 2.4 mil M-Diamant = 17 µ M-Diamond = 0.7 mil	für Normal-, Mikrorillen- und Stereo-Schallplatten for normal (78 rpm)-, micro- groove and stereo records pour disques normaux, micro et stéréo	14 D - U 66 207 541	silber/braun silver/brown argent/brun	23.20 G

1004 D / Changeur de disques Dual 1004 S, 1004 D

Kristallsysteme mit Abtastnadeln Crystal Pick-Up Cartridges with Styli Cellules piezo avec pointes de lecture	B.-No.	Preis je Stück ohne MwSt. DM	Saphir-Abtastnadeln Sapphire Styli Pointes de lecture saphir	B.-No.	Preis je Stück ohne MwSt. DM
CDS 320/3 	Kennfarbe Color Code Couleur 14 D - U 42 207 545 rot red rouge	18.20 E	DN 3  N M N-Saphir = 60 µ N-Sapphire = 2.4 mil M-Saphir = 17 µ M-Sapphire = 0.7 mil	14 D - U 62 207 542 braun brown brun	5.40 G
CDS 3 	Kennfarbe Color Code Couleur 14 A - U 50 207 515 weiß white blanc	13.20 E	DN 2  M N N-Saphir = 60 µ N-Sapphire = 2.4 mil M-Saphir = 23 µ M-Sapphire = 1 mil	14 A - U 40 207 514 blau blue bleu	5.40 G

Pointes de lecture spéciales

für / for / pour CDS 3

DN 23  M-Diamant = 17 µ M-Diamond = 0.7 mil	für Mikrorillen- und Stereo- Schallplatten for micro- groove and stereo records pour disques micro et stéréo	14 A - U 43 207 513 gold gold or	21.80 G
DN 26  M-Saphir = 17 µ M-Sapphire = 0.7 mil	für Mikrorillen- und Stereo-Schallplatten for micro-groove and stereo records pour disques micro et stéréo	14 A - U 48 207 512 rot red rouge	4.20 G



Plattenwechsler Dual 1005, 1003 / Record Changer Dual 1005, 1003

Tonabnehmerköpfe komplett Pick-Up Heads Complete Têtes de lecture complètes	Verwendungszweck Kenndaten Application Data Utilisation Données caractéristiques	B.-No.	Preis Je Stück ohne MwSt. DM	Köpfe ohne System Heads without Cartridges Têtes sans cellule B.-No.	Preis je Stück ohne MwSt. DM
	Normal- und Mikrorillen- Schallplatten Auflagekraft 9 p				
	Normal (78 rpm) and micro- groove records Tracking weight 9 p	14 B - U 60 207 523	19.—	14 B - U 62 207 525	5.80
	Disques normaux et micro. Force d'appui 9 p		E		E



Plattenwechsler Dual 1004 / Record Changer Dual 1004

	Normal- und Mikrorillen- Schallplatten Auflagekraft 9 p				
	Normal (78 rpm) and micro- groove records Tracking weight 9 p	14 C - U 70 207 530	19.—	14 C - U 80 207 531	5.80
	Disques normaux et micro. Force d'appui 9 p		E		E



Spezial-Abtastnadeln für TA System CDS 3 / Special styli for pick-up cartridge

DN 22  M 1 - Saphir = 23 µ M 1 - Sapphire = 1 mil M 2 - Saphir = 23 µ M 2 - Sapphire = 1 mil	für Mikrorillen- Schallplatten for micro-groove records pour disques micro	14 A - U 42 207 518	5.40		
		rot red rouge		G	
DN 23  M-Diamant = 17 µ M-Diamond = 0.7 mil	für Mikrorillen- Schallplatten for micro-groove records pour disques micro	14 A - U 43 207 513	21.80		
		gold gold or		G	



Changeur de disques Dual 1005, 1003

Kristallsysteme mit Abtastnadeln Crystal Pick-Up Cartridges with Styli Cellules piezo avec pointes de lecture	B.-No.	Preis je Stück ohne MwSt. DM	Saphir-Abtastnadeln Sapphire Styli Pointes de lecture saphir	B.-No.	Preis je Stück ohne MwSt. DM
	14 A - U 50 207 515	13.20	DN 2  M N	14 A - U 40 207 514	5.40
	weiß white blanc	E	N-Saphir = 60 µ N-Sapphire = 2.4 mil M-Saphir = 23 µ M-Sapphire = 1 mil	blau blue bleu	G

Changeur de disques Dual 1004

	14 A - U 50 207 515	13.20	DN 2  M N	14 A - U 40 207 514	5.40
	weiß white blanc	E	N-Saphir = 60 µ N-Sapphire = 2.4 mil M-Saphir = 23 µ M-Sapphire = 1 mil	blau blue bleu	G

CDS 3 / Pointes spéciales pour cellule CDS 3

DN 24  N-Saphir = 60 µ N-Sapphire = 2.4 mil M-Diamant = 17 µ M-Diamond = 0.7 mil	für Normal-, Mikrorillen- und Stereo-Schallplatten for normal (78 rpm)-, micro- groove and stereo records pour disques normaux, micro et stéréo	14 A - U 44 207 517	23.20		
		silber silver argent		G	
DN 26  M-Saphir = 17 µ M-Sapphire = 0.7 mil	für Mikrorillen- Schallplatten for micro- groove records pour disques micro	14 A - U 48 207 512	4.20		
		rot red rouge		G	



Plattenwechsler Dual 1002 F, 1002 E / Record Changer Dual 1002 F, 1002 E
Plattenspieler Dual 270, 275 / Record Player Dual 270, 275

Tonabnehmerköpfe komplett Pick-Up Heads Complete Têtes de lecture complètes	Verwendungszweck Kenndaten Application Data Utilisation Données caractéristiques	B.-No.	Preis je Stück ohne MwSt. DM	Köpfe ohne System Heads without Cartridges Têtes sans cellule B.-No.	Preis je Stück ohne MwSt. DM
	Normal- und Mikrorillen- Schallplatten Auflagekraft 9 p Normal groove (78 rpm) and micro- groove records Tracking weight 9 p Disques normaux et micro . Force d'appui 9 p	7500 - U 2 209 294	18.— E	7500 - U 19 209 295	4.80 E
TA-Kopf E Pick-up head E Tête de lecture E	Nicht mehr lieferbar / Ersetzt durch: TA-Kopf F No longer available / Replaced by: Pick-up head F Épuisé / Remplacée par tête F				



Plattenwechsler Dual 1002, 1002 D / Record Changer Dual 1002, 1002 D

	Normal- und Mikrorillen- Schallplatten Auflagekraft 9 p Normal groove (78 rpm) and micro- groove records Tracking weight 9 p Disques normaux et micro . Force d'appui 9 p	7500 - U 16 209 296	18.— E	7500 - U 18 209 297	4.80 E
---	--	------------------------	---------------	------------------------	---------------



Spezial-Abtastnadeln für TA Systeme CDS 2 und CDS 3 / Special styli for pick-up cartridges

	14 A - U 42 207 518 rot red rouge	5.40		14 A - U 43 207 513 gold gold or	21.80
für Mikrorillen- Schallplatten for micro -groove records pour disques micro M 1 - Saphir = 23 µ M 1 - Sapphire = 1 mil M 2 - Saphir = 23 µ M 2 - Sapphire = 1 mil		G	für Mikrorillen- Schallplatten for micro -groove records pour disques micro M-Diamant = 17 µ M-Diamond = 0,7 mil		G



Changeur de disques Dual 1002 F, 1002 E
Tourne-disques 270, 275

Kristallsysteme mit Abtastnadeln Crystal Pick-Up Cartridges with Styli Cellules piezo avec pointes de lecture	B.-No.	Preis je Stück ohne MwSt. DM	Saphir-Abtastnadeln Sapphire Styli Pointes de lecture saphir	B.-No.	Preis je Stück ohne MwSt. DM
CDS 2 	7533 - U 4 209 299 weiß white blanc	13.20 E	DN 2  M N N-Saphir = 60 µ N-Sapphire = 2,4 mil M-Saphir = 23 µ M-Sapphire = 1 mil	14 A - U 40 207 514 blau blue bleu	5.40 G
KST 5 CDS 1	Nicht mehr lieferbar No longer available Épuisé		DN 1  M N	7531 - U 1 214 787	5.40 G

Changeur de disques Dual 1002, 1002 D

	7533 - U 4 209 299 weiß white blanc	13.20 E	DN 2  M N N-Saphir = 60 µ N-Sapphire = 2,4 mil M-Saphir = 23 µ M-Sapphire = 1 mil	14 A - U 40 207 514 blau blue bleu	5.40 G
--	---	----------------	---	--	---------------

CDS 2 and CDS 3 / Pointes spéciales pour cellules CDS 2 et CDS 3

	14 A - U 44 207 517 silber silver argent	23.20		14 A - U 48 207 512 rot red rouge	4.20
N-Saphir = 60 µ N-Sapphire = 2,4 mil M-Diamant = 17 µ M-Diamond = 0,7 mil		G	für Mikrorillen- Schallplatten for micro - groove records pour disques micro M-Saphir = 17 µ M-Sapphire = 0,7 mil		G

Plattenspieler Dual 412, 410, 410 B / Record Player Dual 412, 410, 410 B

	Verwendungszweck Kenndaten Application Data Utilisation Données caractéristiques		Preis je Stück ohne MwSt. DM
	<p>Normal-, Mikrorillen- und Stereo-Schallplatten Auflagekraft 3,5-4,5 p</p> <p>Normal (78 rpm), micro-groove and stereo records Tracking weight 3,5-4,5 p</p> <p>Disques normaux, micro et stéréo Force d'appui 3,5-4,5 p</p>	<p>Tonabnehmerkopf ist vom Gerät nicht abnehmbar</p> <p>The pick-up head is not removable from the unit</p> <p>La tête de lecture ne peut pas être séparée de l'appareil</p>	

Spezial-Abtastnadeln / Special styli

DN 54	 <p>M-Diamant = 17 µ M-Diamond = 0.7 mil N-Saphir = 60 µ N-Sapphire = 2.4 mil</p>	<p>für Normal-, Mikrorillen- und Stereo-Schallplatten</p> <p>for normal (78 rpm) micro-groove and stereo records</p> <p>pour disques normaux, micro et stéréo</p>	<p>14 K - U 506</p> <p>202 531</p>	<p>24.50</p> <p>G</p>
-------	---	---	------------------------------------	-----------------------

Plattenspieler Dual 400 / Record Player Dual 400



	<p>Normal-, Mikrorillen- und Stereo-Schallplatten Auflagekraft 5,5 p</p> <p>Normal (78 rpm), micro-groove and stereo records Tracking weight 5,5 p</p> <p>Disques normaux, micro et stéréo Force d'appui 5,5 p</p>	<p>Tonabnehmerkopf ist vom Gerät nicht abnehmbar</p> <p>The pick-up head is not removable from the unit</p> <p>La tête de lecture ne peut pas être séparée de l'appareil</p>	
--	---	--	--

Plattenspieler Dual 400 B / Record Player Dual 400 B

	<p>Normal-, Mikrorillen- und Stereo-Schallplatten Auflagekraft 5,5 p</p> <p>Normal (78 rpm), micro-groove and stereo records Tracking weight 5,5 p</p> <p>Disques normaux, micro et stéréo Force d'appui 5,5 p</p>	<p>Tonabnehmerkopf ist vom Gerät nicht abnehmbar</p> <p>The pick-up head is not removable from the unit</p> <p>La tête de lecture ne peut pas être séparée de l'appareil</p>	
--	---	--	--

Spezial-Abtastnadeln für CDS 520 / 521 Seite 34 und 35 / Special styli for CDS 520 / 521



Tourne-disques Dual 412, 410, 410 B

Kristallsysteme mit Abtastnadeln Crystal Pick-Up Cartridges with Styli Cellules piezo avec pointes de lecture	B.-No. Kennfarbe Color Code Couleur	Preis je Stück ohne MwSt. DM	Saphir- und Diamant- Abtastnadeln Sapphire and Diamond Styli Pointes de lecture saphir et diamant	B.-No. Kennfarbe Color Code Couleur	Preis je Stück ohne MwSt. DM
CDS 630/5 			DN 5 		
	14 K - U 342	21.—	M-Saphir = 17 µ M-Sapphire = 0.7 mil N-Saphir = 60 µ N-Sapphire = 2.4 mil	14 K - U 502	7.30
	202 521	E		202 529	G



Pointes de lecture spéciales

DN 52	 <p>M-Saphir = 17 µ M-Sapphire = 0.7 mil M-Saphir = 23 µ M-Sapphire = 1 mil</p>	<p>für Mikrorillen- und Stereo- Schallplatten</p> <p>for micro- groove and stereo records</p> <p>pour disques micro et stéréo</p>	<p>14 K - U 504</p> <p>202 530</p>	<p>7.30</p> <p>G</p>
-------	--	---	------------------------------------	----------------------

Tourne-disques Dual 400

CDS 520/3 	14 F - U 42	18.20	DN 3 	14 D - U 62	5.40
	207 562	E	N-Saphir = 60 µ N-Sapphire = 2.4 mil M-Saphir = 17 µ M-Sapphire = 0.7 mil	207 542	G
	weiß white blanc			braun brown brun	
CDS 520/34 	14 F - U 44	36.—	DN 34 Saphir-Diamant Sapphire-Diamond	14 D - U 66	23.20
	207 563	E		207 541	G

Tourne-disques Dual 400 B

CDS 521/3 	14 F - U 47	18.20	DN 3 	14 D - U 62	5.40
	207 564	E	N-Saphir = 60 µ N-Sapphire = 2.4 mil M-Saphir = 17 µ M-Sapphire = 0.7 mil	207 542	G
	weiß white blanc			braun brown brun	

page 34 and 35 / Pointes de lecture spéciales pour CDS 520 / 521 page 34 et 35



Plattenspieler Dual 300 A / Record Player Dual 300 A

Verwendungszweck Kenndaten Application Data Utilisation Données caractéristiques		
	<p>Normal-, Mikrorillen- und Stereo-Schallplatten Auffagekraft 5,5 p</p> <p>Normal (78 rpm), micro-groove and stereo records Tracking weight 5.5 p</p> <p>Disques normaux, micro et stéréo Force d'appui 5,5 p</p>	<p>Tonabnehmerkopf ist vom Gerät nicht abnehmbar</p> <p>The pick-up head is not removable from the unit</p> <p>La tête de lecture ne peut pas être séparée de l'appareil</p>





Plattenspieler Dual 300 B / Record Player Dual 300 B

	<p>Normal-, Mikrorillen- und Stereo-Schallplatten Auffagekraft 5,5 p</p> <p>Normal (78 rpm), micro-groove and stereo records Tracking weight 5.5 p</p> <p>Disques normaux, micro et stéréo Force d'appui 5,5 p</p>	<p>Tonabnehmerkopf ist vom Gerät nicht abnehmbar</p> <p>The pick-up head is not removable from the unit</p> <p>La tête de lecture ne peut pas être séparée de l'appareil</p>
---	---	--

Spezial-Abtastnadeln für TA-Systeme CDS 520, CDS 521 / Special styli for pick-up cartridges

DN 23  M-Diamant = 17 µ M-Diamond = 0.7 mil	für Mikrorillen- und Stereo-Schallplatten for micro-groove and stereo records pour disques micro et stéréo	14 A - U 43 207 513 gold gold or	21.80 G	DN 26  M-Saphir = 17 µ M-Sapphire = 0,7 mil
--	--	--	----------------	--

Tourne-disques Dual 300 A

Kristallsysteme mit Abtastnadeln Crystal Pick-Up Cartridges with Styli Cellules piezo avec pointes de lecture	B.-No. Kennfarbe Color Code Couleur	Preis je Stück ohne MwSt. DM	Saphir- und Diamant-Abtastnadeln Sapphire and Diamond Styli Pointes de lecture saphir et diamant	B.-No. Kennfarbe Color Code Couleur	Preis je Stück ohne MwSt. DM
CDS 520/3 	14 F - U 42 207 562 weiß white blanc	18.20 E	DN 3 N M  N-Saphir = 60 µ N-Sapphire = 2,4 mil M-Saphir = 17 µ M-Sapphire = 0.7 mil	14 D - U 62 207 542 braun brown brun	5.40 G
CDS 520/34 	14 F - U 44 207 563 weiß white blanc	36.— E	DN 34 N M  N-Saphir = 60 µ N-Sapphire = 2,4 mil M-Diamant = 17 µ M-Diamond = 0,7 mil	14 D - U 66 207 541 silber/braun silver/brown argent/brun	23.20 G

Tourne-disques Dual 300 B

CDS 521/3 	14 F - U 47 207 564 weiß white blanc	18.20 E	DN 3 N M  N-Saphir = 60 µ N-Sapphire = 2,4 mil M-Saphir = 17 µ M-Sapphire = 0.7 mil	14 D - U 62 207 542 braun brown brun	5.40 G
---	--	----------------	---	--	---------------

CDS 520, CDS 521 / Pointes de lecture spéciales pour cellules CDS 520, CDS 521

für Mikrorillen- und Stereo-Schallplatten for micro-groove and stereo records pour disques micro et stéréo	14 A - U 48 207 512 rot red rouge	4.20 G	DN 32 M2 M1  M 1 - Saphir = 17 µ M 1 - Sapphire = 0.7 mil M 2 - Saphir = 23 µ M 2 - Sapphire = 1 mil	für Mikrorillen- und Stereo-Schallplatten for micro-groove and stereo records pour disques micro et stéréo	14 D - U 64 207 540 rot red rouge	5.40 G
--	---	---------------	---	--	---	---------------

Plattenspieler Dual 300 / Record Player Dual 300

	Verwendungszweck Kenndaten Application Data Utilisation Données caractéristiques	
	<p>Normal-, Mikrorillen- und Stereo-Schallplatten Auflagekraft 5,5 p</p> <p>Normal (78 rpm), micro-groove and stereo records Tracking weight 5.5 p</p> <p>Disques normaux, micro et stéréo Force d'appui 5,5 p</p>	<p>Tonabnehmerkopf ist vom Gerät nicht abnehmbar</p> <p>The pick-up head is not removable from the unit</p> <p>La tête de lecture ne peut pas être séparée de l'appareil</p>



Der Plattenspieler 300 wurde auch „stereovorbereitet“, bestückt mit monauralem TA-System CDS 310/3, geliefert. Bei Ersatzbedarf ist das Stereo-TA-System CDS 320/3 zu verwenden.

The Record Player 300 with pick-up cartridge CDS 310/3 was also supplied already wired for stereo. If replacement is required the stereo pick-up cartridge CDS 320/3 should be used.



Plattenspieler Dual 295 / Record Player Dual 295

	Normal- und Mikrorillen Schallplatten Auflagekraft 9 p Normal (78 rpm) and micro-groove records Tracking weight 9 p Disques normaux et micro Force d'appui 9 p	
		<p>Tonabnehmerkopf ist vom Gerät nicht abnehmbar</p> <p>The pick-up head is not removable from the unit</p> <p>La tête de lecture ne peut pas être séparée de l'appareil</p>

Spezial-Abtastnadeln für CDS 2, CDS 310 / Special styli for CDS 2, CDS 310
Pointes spéciales pour CDS 2, CDS 310

DN 22			DN 24		
					
für Mikrorillen-Schallplatten for micro-groove records pour disques micro	14 A - U 42	5.40	für Normal- und Mikrorillen-Schallplatten for normal (78 rpm) and micro-groove records pour disques normaux et micro	14 A - U 44	23.20
M 1 - Saphir = 23 µ M 1 - Sapphire = 1 mil M 2 - Saphir = 23 µ M 2 - Sapphire = 1 mil	207 518		M-Diamant = 17 µ N-Saphir = 60 µ	207 517	
	rot red rouge		silber silver argent		
		G			G

Tourne-disques Dual 300



Kristallsysteme mit Abtastnadeln Crystal Pick-Up Cartridges with Styli Cellules piezo avec pointes de lecture	B.-No. Kennfarbe Color Code Couleur	Preis je Stück ohne MwSt. DM	Saphir- und Diamant- Abtastnadeln Sapphire and Diamond Styli Pointes de lecture saphir et diamant	B.-No. Kennfarbe Color Code Couleur	Preis je Stück ohne MwSt. DM
CDS 320/3 	14 D - U 42 207 545 rot red rouge	18.20	DN 3  N-Saphir = 60 µ N-Sapphire = 2.4 mil M-Saphir = 17 µ M-Sapphire = 0.7 mil	14 D - U 62 207 542 braun brown brun	5.40
		E			G





Le Tourne-disques 300 a été fourni en son temps en une version préparée à la stéréophonie, mais était équipé de la cellule monaurale CDS 310/3. En cas de remplacement utilisez la cellule CDS 320/3.



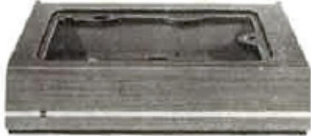

Tourne-disques Dual 295

CDS 2 	7533 - U 4 209 299 weiß white blanc	13.20	DN 2  N-Saphir = 60 µ N-Sapphire = 2.4 mil M-Saphir = 23 µ M-Sapphire = 1 mil	14 A - U 40 207 514 blau blue bleu	5.40
		E			G

Spezial-Abtastnadeln für CDS 320 / Special styli for CDS 320
Pointes spéciales pour CDS 320

DN 32			DN 34		
					
für Mikrorillen- und Stereo-Schallplatten for micro-groove and stereo records pour disques micro et stéréo	14 D - U 64	5.40	für Normal-, Mikrorillen- und Stereo-Schallplatten for normal (78 rpm)-, micro-groove and stereo records pour disques normaux, micro et stéréo	14 D - U 66	23.20
M 1 - Saphir = 17 µ M 1 - Sapphire = 0.7 mil M 2 - Saphir = 23 µ M 2 - Sapphire = 1 mil	207 540		N-Saphir = 60 µ N-Sapphire = 2.4 mil M-Diamant = 17 µ M-Diamond = 0.7 mil	207 541	
	rot red rouge		silber/braun silver/brown argent/brun		
		G			G

für Geräte-Type for model pour appareil	Type und Abbildung Type and Illustration Type et Figure	B.-No.	Preis je Stück ohne MwSt. DM
1009/SK/SK2/F 1010/A/S/F 1011 1015/F 1019	CK 5  Konsole / Mounting base / Console	70 A - Ausf. A 203 148	44.—* C
CK 2 CK 5	CH 5  Abdeckhaube / Cover / Couvercle	24 R - Ausf. A 203 211	34.—* C
HS 20 HS 21	GF 1  Gerätefuß Equipment stand Support	29 H - Ausf. A 208 170	47.—* B
CL 16 CL 18 CL 20	LF 1  Lautsprecherfuß (2 Stück) Stand for Loudspeaker (2 pieces) Support pour haut-parleur (2 pièces)	215 453	89.—* /Paar C

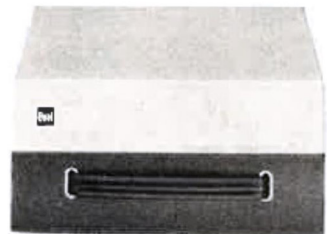
für Geräte-Type for model pour appareil	Type und Abbildung Type and Illustration Type et Figure	B.-No.	Preis je Stück ohne MwSt. DM
400 410	CK 8 	24 F - Ausf. A 213 070	23.—*
1010/A/S/F 1011 1015 F 1009 1008 SK 1009 SK 2 1009 F 1019	CK 9  Aufstellungssockel / Mounting base / Socle	24 G - Ausf. A 313 046	26.50* C
HR 1 CK 8 H 400 V H 410 V H 410 V 1	CH 8 	24 U - Ausf. A 213 043	15.50* C
HR 2 CK 9 H 1010 V H 1010 AV H 1010 SV HS 10 HS 11	CH 9  Klarsichthaube / Cover / Couvercle	24 V - Ausf. A 213 041	26.50* C
Die Klarsichthaube CH 9 kann für die Geräte 1009/SK / SK2 / F und 1019 nicht verwendet werden. The cover CH 9 is not to be used with the units 1009/SK / SK2 / F and 1019. Le couvercle CH 9 ne peut être appliqué aux appareils 1009/SK / SK2 / F et 1019.			
1010 1010 A 1010 S 1010 F 1011 1015 1015 F	L 2  Leerkoffer / Empty case / Valise vide	22 H - U 2 202 959	Preis auf Anfrage K

Zur Anpassung der Geräte an unterschiedliche Netzfrequenzen.
For adapting units to various line frequencies.
Pour entrainement des appareils à différentes périodes.



Geräte-Type Model Appareil	Netzfrequenz Line Frequency Périodes Hz (cps)	Bestell-Nr. Part Number No. de Cde.	Preis je Stück ohne MwSt. DM	
1019	50	31 N - U 20	204 503	1.40
1009	60	31 N - U 28	204 511	E
1016	50	31 R - U 44	204 638	—,90
1015	60	31 R - U 54	204 648	E
1015 F	50	12 V - U 16	212 115	1.10
	60	12 V - U 22	212 116	
1009 F	50	12 X - U 14	212 145	E
	60	12 X - U 20	212 146	
1010 F } 2 Pol-Motor	50	12 W - U 14	212 135	—,90
	60	12 W - U 20	212 136	
1009 SK	50	31 N - U 45	204 526	—,90
1009 SK 2	60	31 N - U 54	204 535	
1011 1010 A } 2 Pol-Motor 1010 S 1010	50	12 G - U 45	200 764	E
	60	12 G - U 55	207 353	
1006 A 1006 AM	50	31 E - 64	208 305	—,45
1006 1006 M	60	31 E - 74	208 307	E
1008 A 1008	50	31 B - 50	208 200	—,27
1007 A 1007	60	31 B - 63	208 213	
1005 1004 S 1004 SD 1004 D 1004	50	31 B - 52	208 202	—,27
	60	31 B - 59	208 209	
1003	50	11 A - 238	206 385	E
	60	11 A - 331	206 393	
410	50	11 M - U 114	200 240	—,90
	60	11 M - U 135	200 251	
400	50	11 K - U 184	206 561	E
	60	11 K - U 204	206 562	
300 A 300 295	50	31 B - 49	208 197	—,27
	60	31 B - 64	208 214	E



Zur Ausübung eines guten Service liefern wir:

- Nadelmikroskope (Abbildung)
- Stroboskopscheiben
- Reparaturböcke
- Federwaagen
- Schmierstoffkästen
- Abziehvorrichtungen

For providing an excellent service we have available:

- Stylus microscopes (illustration)
- Stroboscope discs
- Repair stands
- Spring scales
- Lubrication kits
- Pulley extractors

Pour l'exécution d'un bon "Service après-vente", nous fournissons:

- Loupe pour pointes de lecture (figure)
- Disques stroboscopiques
- Support pour réparation des changeurs
- Pèse-bras
- Étuis contenant des produits de lubrification
- Extracteur de gaiets

Dual-Werksvertretungen

Dual-Kundendienststellen

Platz	Firma	Straße	Telefon-Vorwahl-Nr.	Telefon-Nr. FS-Nr.
1000 Berlin 41	H. F. Rohde	Schmargendorfer Str. 17	0311	837137/38 FS 0183460
2800 Bremen	Rolf Kern	Langenstraße 58	0421	310881/83 FS 0244305
4600 Dortmund	Hubert Kampschulte	Ruhrallee 55	0231	26057/58
4000 Düsseldorf	H. W. Kleemann	Lindenstraße 47	0211	684541/42
6000 Frankfurt-Eschborn	Werner Hopf KG	Frankfurter Straße 5—7	0611	41441 FS 0412087
7800 Freiburg	Friedrich Seibel	Kartäuserstraße 35	0761	33934
2000 Hamburg 50	Georg Himstedt	Bernstorffstraße 76	0411	437012/13 FS 0212866
3000 Hannover	Gerhard Bartel	Haltenhoffstraße 50	0511	714041 FS 0923771
5860 Iserlohn	Wilhelm Völker	Ohlstraße 41	02371	24256
3500 Kassel	Bruno Herz	Grüner Weg 19	0561	12098
2300 Kiel	Erich Hesse	Westring 333 a	0431	44623/24
5400 Koblenz	Alfons Michels	Rizzastraße 28	0261	34983
5000 Köln	Alfons Michels	Neue Maastrichter Straße 12/14	0221	522071
6800 Mannheim	Hans Hettergott KG	H 7/28	0621	25561 FS 0462579
8000 München 19	Heinz Seibt	Andréestraße 5	0811	5164251 und 5167469 FS 0524853
8500 Nürnberg	Werner Weidner	Heideloffstraße 21—23	0911	445651/53 FS 0622848
4500 Osnabrück	Walter Diekhöner	Martinistraße 63	0541	45071/72
7980 Ravensburg	Wilhelm Michels	Hindenburgstraße 36	0751	4722/23
6600 Saarbrücken 3	Josef Bucker	Heinrich-Böcking-Str. 7	0681	67071/72
7012 Stuttgart/Fellb.	Helmut Braun	Schorndorfer Straße 40	0711	587585/86 FS 0723419

Platz	Firma	Straße	Telefon-Vorwahl-Nr.	Telefon-Nr. FS-Nr.
5100 Aachen	H. Marschik	Lothringer Straße 37	0241	37181
8900 Augsburg	O. Cieslicke	Dominikanergasse 20	0821	20639
1000 Berlin 41	H. F. Rohde	Schmargendorfer Str. 17	0311	837137/38 FS 0183460
4800 Bielefeld	Walter Diekhöner	Hauptstraße 247	0521	23071
4800 Bielefeld	A. Rothgänger	Ernst-Rein-Straße 48	0521	65940
3300 Braunschweig	Ing. Karl Bösche	Bültenweg 93	0531	31405 und 31269
2800 Bremen	Rolf Kern	Langenstraße 58	0421	310881—83 FS 0244305
4600 Dortmund	Hubert Kampschulte	Ruhrallee 55	0231	26057/58
4000 Düsseldorf	H. W. Kleemann	Lindenstraße 47	0211	684541/42
4300 Essen	Gerstner & Marquardt	Münchener Straße 48	02141	239745/46
2390 Flensburg	Peter Jepsen	Bahnhofstraße 23	0461	22272
6000 Frankfurt-Eschborn	Werner Hopf KG	Frankfurter Straße 5—7	0611	41441 FS 0412087
7800 Freiburg	Friedrich Seibel	Kartäuserstraße 35	0761	33934
2000 Hamburg 50	Georg Himstedt	Bernstorffstraße 76	0411	437012/13 FS 0212866
3000 Hannover-M	Fritz Kotte	Blumenstraße 1	0511	21291
5860 Iserlohn	Wilhelm Völker	Ohlstraße 41	02371	24256
7500 Karlsruhe	E. Dzierzawa	Lessingstraße 74	0721	27089
3500 Kassel	Bruno Herz	Grüner Weg 19	0561	12098
2300 Kiel	H. W. Föh	Langer Segen 8—10	0431	41457
5400 Koblenz	Alfons Michels	Rizzastraße 28	0261	34983
5000 Köln	Alfons Michels	Neue Maastrichter Straße 12/14	0221	522071
6800 Mannheim	W. Streicher	U 6/6	0621	21157
8000 München 19	Heinz Seibt	Andréestraße 5	0811	5164251 und 5167469 FS 0524853
4400 Münster	Emil Neher	Hammer Straße 230	0251	41143/44
8500 Nürnberg	Werner Weidner	Heideloffstraße 21—23	0911	445651/53 FS 0622848
4500 Osnabrück	Walter Diekhöner	Martinistraße 63	0541	45071/72
7980 Ravensburg	Wilhelm Michels	Hindenburgstraße 36	0751	4722/23
8400 Regensburg	Heinrich Lederer	Am Vitusbach 19	0941	30809
6600 Saarbrücken 3	Josef Bucker	Heinrich-Böcking-Str. 7	0681	67071/72
5900 Siegen	Prümeß, Inh. G. Kill	Adolfstraße 9	0271	62595
7012 Stuttgart/Fellb.	Helmut Braun	Schorndorfer Straße 40	0711	587585/86 FS 0723419
5500 Trier	Elektro-Goebel	Petrusstraße 4	0651	73422
8700 Würzburg	K. Rückert	Herzogenstraße 11	0931	54387



Service

Dual Gebrüder Steidinger · 7742 St. Georgen / Schwarzwald