

AKAI

AUDIO
EQUIPMENT
1975/76

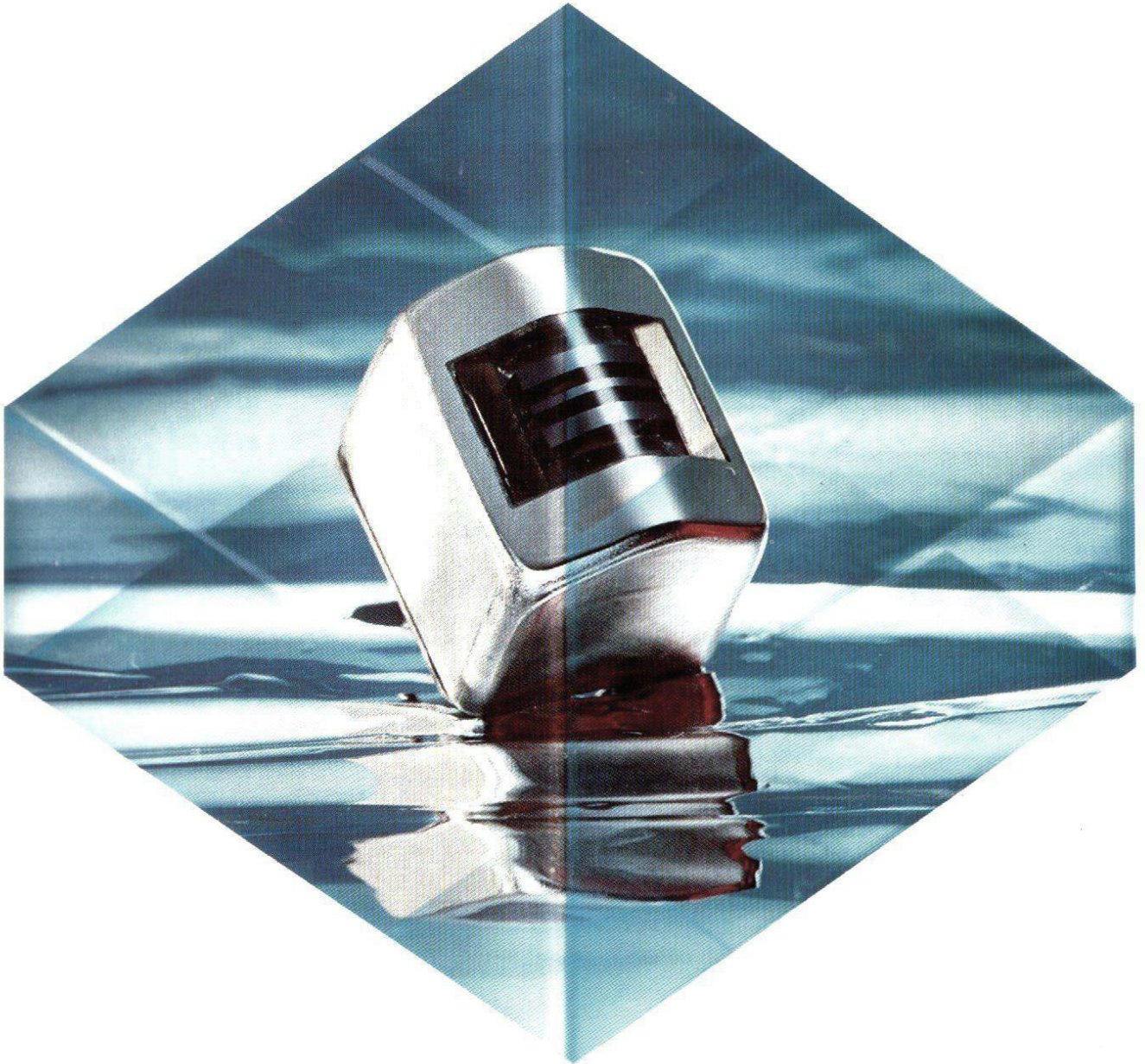

GX-265D

FORWARD AND REVERSE RECORDING
AND PLAYBACK STEREO TAPE DECK



AC SERVO MOTOR DIRECT CENTER CAPSTAN DRIVE SYSTEM

One each GX forward recording, GX reverse recording, GX forward playback, GX reverse playback, forward erase, and reverse erase head make up the reverse recording and playback system of this model. The quality and special process of the GX Head materials

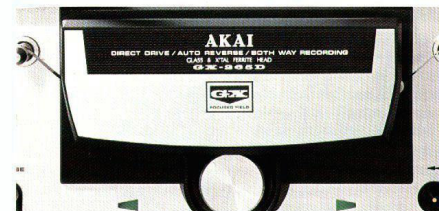

result in a wider dynamic range, better high frequency characteristics and tone quality and longer lasting performance.

Further, the arrangement of the head block is completely symmetrical in relation to the center capstan. The short and equi-distant tape path within the head block and between heads and reel tables on both sides assure identical performance in both directions.

The GX-265D employs a 3 motor drive system with a new C.P.G. (center pole frequency generated) AC Servo Motor for direct capstan drive. A magnetic pole is established in the center for equal radiation to the outer circumference of the motor and rubber belts, flywheels, etc. are eliminated for reduced interference. This

coupled with the center capstan system of this model reduces wow and flutter to an amazing 0.06%.RMS.

- Automatic and Manual Forward and Reverse Recording and Playback
- 6-Head 3-Motor System
- AC Servo-Control Motor for Direct Center Capstan Drive
- Symmetrical Head Block Layout for Identical Recording and Playback Performance in Both Directions
- Amazingly Low 0.06% RMS Wow and Flutter
- Microphone and Line Mixing
- Extended +5 VU Meter Scales for Precise Level Indication
- Quick Pause Control
- Automatic Stop Function
- Individual Track Selectors for Monaural or Stereo Performance
- Output Level Control
- Tape Selector Switch
- Feather Touch Controls for Easy and Smooth Mode Selection
- Dual Monitoring

Tape Speed 7-1/2 and 3-3/4 ips (±0.7%)
Wow/Flutter Less than 0.06% RMS at 7-1/2 ips
Frequency Response 30—25,000 Hz (±3dB) at 7-1/2 ips 30—19,000 Hz (±3dB) at 3-3/4 ips (using Akai LN-150-7 Tape)
Distortion Less than 0.5% (1 KHz, 0VU)
Signal-To-Noise Ratio Better than 56 dB (+6VU, peak level recording)
Dimensions 17.4"(W) x 15.9"(H) x 8.2"(D) (441 x 404 x 207mm)
Weight 36.5 lbs (16.6 kg)



Platinum crucible during ferrite melting process

REVOLUTIONARY GX HEAD



Better signal-to-noise ratio, extended high frequency and a more dynamic range. These features are contributable to the characteristics of Akai's amazing GX Head focused field recording system. The core of the

GX Head is made of crystal ferrite which is mounted and set in glass of the same hardness. The superior characteristics of the head material and special processing enabled the forming of a perfectly lineal shallow head gap and head contour wherein the tape is exposed only to the part of the head's sharply focused magnetic field. This system assures optimum head-to-tape con-

tact, eliminates sound drop out, and improves head sensitivity. And GX Head sound is fully maintained for lasting new machine performance.

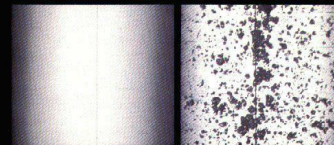

Gap environs of Crystal Ferrite Head. Gap environs of poly-ferrite head.

After equal use, Enlarged to 800 times actual size.

■2-CHANNEL OPEN REEL TAPE DECK

GX-210D

THREE MOTOR AUTOMATIC REVERSE
STEREO TAPE DECK



3-MOTOR DRIVE MECHANISM INCLUDES SELF-LUBRICATING HYSTERESIS SYNCHRONOUS MOTOR

Felt
Oil bearing metal
Cellulose fiber
Oil circulating path

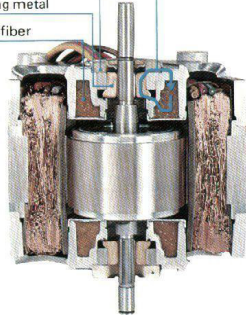

To match the lasting performance of the GX Head, the GX-210D is equipped with Akai's unique self-lubricating capstan motor. The installation of two oil circulating mechanisms with cellulose fibers within the interior of the motor provides long lasting, trouble-free operation. Oil circulating speed is adjusted naturally according to motor revolutions and temperature, and because shaft rotation is always smooth and stable, various mechanical troubles resulting from oil circulation suspension do not occur. Further, these unique cellulose fibers also function as filters to keep the oil clean during the circulating

process, adding to the motor's epoch-making longevity. Two highly efficient outer-rotor motors for supply and take-up reel drive assure consistent and smooth tape travel and ideal starting torque.

- Automatic and Manual Reverse Playback
- Akai's Exclusive Glass & X'tal Ferrite Heads
- Self-Lubricating Hysteresis Synchronous Capstan Drive Motor
- Reel Drive Outer-Rotor Motors
- Sturdy 2-Lever Control System
- Instant Tape/Source Monitoring
- Tape Selector for High Performance Low Noise Tape
- Automatic Stop
- Pause Control
- 4-Digit Index Counter for Easy Indexing
- Built-In Reel Retainers.

Tape Speed 7-1/2 and 3-3/4 ips (±0.8%)
Wow/Flutter Less than 0.08% RMS at 7-1/2 ips
Frequency Response 30–25,000 Hz (±3dB) at 7-1/2 ips
40–20,000 Hz (±3dB) at 3-3/4 ips (using Low Noise Tape)
Distortion Less than 1.5% (1 KHz, 0VU)
Signal-To-Noise Ratio Better than 50 dB
Dimensions 14.5"(W) x 14.6"(H) x 8.9"(D)
(368 x 371 x 227mm)
Weight 33.9 lbs (15.4 kg)

■4-CHANNEL OPEN REEL TAPE DECK

GX-280D-SS

THREE MOTOR FOUR HEAD
4/2-CHANNEL
STEREO TAPE DECK



4-CHANNEL SURROUND STEREO

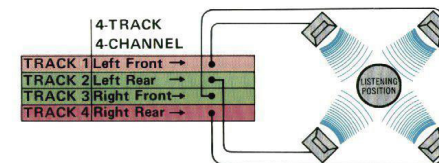

4-CH GX-Head

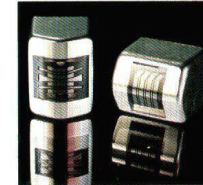

Akai's surround stereo supplements conventional stereo's two front speakers with two additional rear speakers to form the "2-2 system". The listener is surrounded by two sets of speakers (left & right front and left & right rear). This arrangement does not mean, however, that simply adding two speakers to a 2-channel stereo system is all that is necessary for 4-channel stereo playback. Four separate recordings are made using four individual channels (four tracks in one direction) of the magnetic recording tape. This 4-channel stereo tape feeds into four pre and main amplifiers to activate a

4-speaker system. Thus, at playback time, sounds from separate channels are emitted from each speaker providing the listener with a feeling that he is listening to concert hall sound from the best seat in the auditorium. Model GX-280D-SS is a compatible 4-channel/2-channel stereo model. For 2-channel stereo operation, only the front channels are utilized. For exciting 4-channel surround stereo, a 4-channel stereo external amplifier or two 2-channel stereo amplifiers can be used to activate a 4-speaker system.

- Akai's Exclusive Glass & X'tal Ferrite Heads
- Direct Capstan Drive Servo Motor
- 4-Channel Automatic Repeat
- 2-Channel Automatic Continuous Reverse Playback
- Dual Monitoring for Professional Level Setting
- Feather Touch Push Button Direct Function Change Control
- Automatic Stop/Shut-Off
- Built-In Sound Mixer
- Sound-On-Sound Recording
- Pause Control with Lock
- Built-In Reel Retainers
- Jumbo VU Meters
- Remote Control Jack
- Tape Selector Switch

Tape Speed 7-1/2 and 3-3/4 ips (±0.5%)
Wow/Flutter Less than 0.10% RMS at 7-1/2 ips
Frequency Response 20–25,000 Hz (±3dB) at 7-1/2 ips
30–20,000 Hz (±3dB) at 3-3/4 ips (using Low Noise Tape)
Distortion Less than 0.8% (1 KHz, 0VU)
Signal-To-Noise Ratio Better than 55 dB
Dimensions 17.4"(W) x 20.2"(H) x 10"(D)
(435 x 505 x 250mm)
Weight 49.5 lbs (22.4 kg)

1730D-SS

4/2-CHANNEL STEREO TAPE DECK



DEPENDABLE 2-LEVER CONTROL SYSTEM

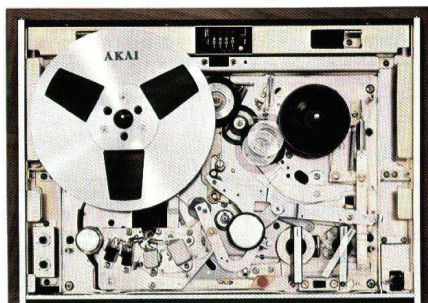

AKAI's dependable 2-lever system complements the high grade parts and robust construction of this rugged 4-channel/2-channel stereo model.

It is regular practice to employ mechanical control in one-motor tape decks. Akai has long since employed this 2-lever system in our one-motor decks. When compared to an ordinary 1-lever system, because the Play/Rec and F. Fwd/Rew Levers are independent, the movable range of the levers are shorter, and operation is lighter. Also, because the F. Fwd/Rew Lever is separate, mis-operation is minimized. Further, because of the mechanical structure of this control system, other parts are not unfavorably influenced and mechanism endurance is extended. Rectangular shaped Control Panel with proportionately balanced controls.

●4-Head System ●Durable 2-Lever Controls for Extra Dependability ●Instant Tape/Source Monitoring ●Newly Designed Slanted Control Panel for Easy Operation ●Front and Rear Channel Headphone Jacks for Easy Monitoring or Private Headphone Listening ●Automatic Stop and Shut-Off ●4-Digit Index Counter ●Built-In Reel Retainers ●Pause Control.

Tape Speed	7-1/2 and 3-3/4 ips (±1%)
Wow/Flutter	Less than 0.12% RMS at 7-1/2 ips
Frequency Response	30-22,000 Hz (±3dB) at 7-1/2 ips 30-15,000 Hz (±3dB) at 3-3/4 ips
Distortion	Less than 1.5% (1 KHz, 0VU)
Signal-To-Noise Ratio	Better than 50 dB
Dimensions	16.5"(W) x 18"(H) x 9.5"(D) (420 x 450 x 240mm)
Weight	33 lbs (15 kg)

GXC-325D

DUAL MONITORING CASSETTE STEREO TAPE DECK

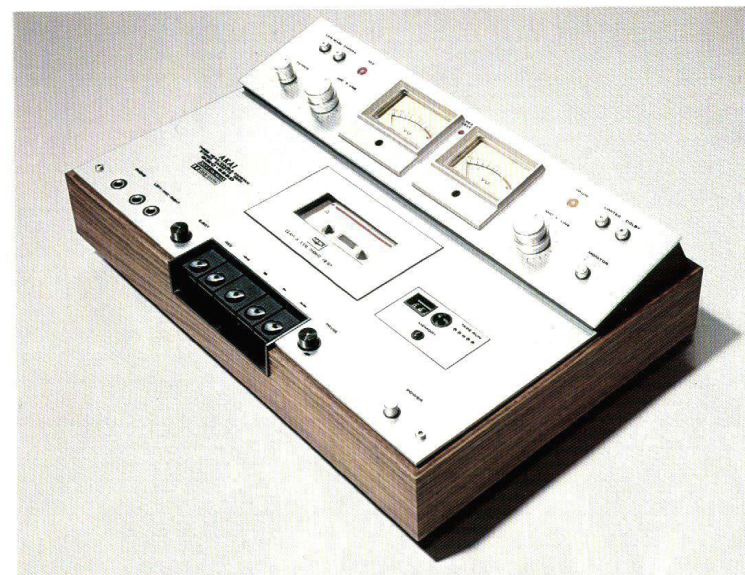

THREE-HEAD CLOSED LOOP DOUBLE CAPSTAN AC SERVO MOTOR DRIVE SYSTEM

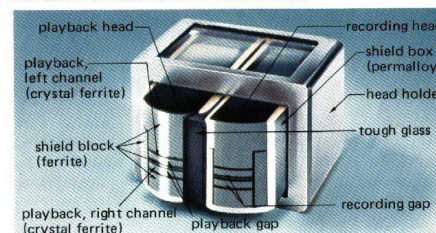

The recording and playback heads of this new 3-head system are Akai's revolutionary GX Heads and are joined for perfect parallelism of recording and playback head gaps. This combined with the Closed Loop Double Capstan system and AC Servo Motor of this model clearly makes it the leader in the field of cassette recording.

Two each capstans and pinch rollers are used, one each of which is positioned in parallel at either side of the head block for stable tape speed and tape tension. This shuts out the adverse influence from outside the "closed" area between capstans so that there is no tape vibration and head-to-tape contact is perfect. Some of the other merits of this system include:

- *Perfect tracking and the elimination of azimuth alignment adjustment mechanisms, beacons, etc.
- *Better S/N ratio and a wider dynamic range.
- *Wow and Flutter reduced to 0.055% WRMS and sound drop-out minimized.
- *3-head system facilitates DUAL MONITORING and because of head portioning, there is no time lag between recording and playback signals during monitoring.
- *Intermodulation suppressed for clearer playback.



*C.P.G. (center pole frequency generated) system of AC Servo Motor results in greater inertia and increased output for extremely quiet operation and accurate motor revolutions.

*Performance not influenced by cassette unevenness.

*Completely stable operation and incomparably clear recording and playback tone quality.

*Lasting new machine performance.

●New 3-Head Cassette System ●Individual Recording/Playback Glass & X'tal Ferrite Heads ●Closed-Loop Double Capstan Drive Mechanism ●Amazingly Low 0.055% WRMS Wow and Flutter ●Newly Designed C.P.G. (center pole frequency generated) AC Servo Motor ●AKAI's exclusive A.D.R. Plus Double Process Dolby Noise Reduction System ●Memory Rewind ●Peak Level Indicator ●Limiter Circuit Prevents Over-Level Recording ●Instantaneous Full Release Automatic Stop ●Output Level Control ●Mic/Line Mixing ●Tape Run Indicator ●Self-Lock Pause Control ●Direct Function Change Control

Tape Speed	1-7/8 ips
Wow/Flutter	Less than 0.055% WRMS
Frequency Response	30-19,000 Hz (±3dB) (using Fe-Cr Tape)
Distortion	Less than 1% (1 KHz, 0VU)
Signal-To-Noise Ratio	Better than 51 dB Dolby Switch ON; Improves up to 10 dB above 5 KHz
Dimensions	17.4"(W) x 5.6"(H) x 11.9"(D) (442 x 142 x 301mm)
Weight	18.9 lbs (8.6 kg)

GXC-75D

REVERSE RECORDING AND PLAYBACK
STEREO TAPE DECK

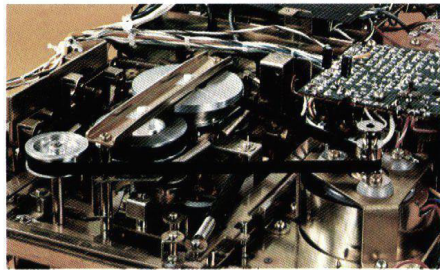
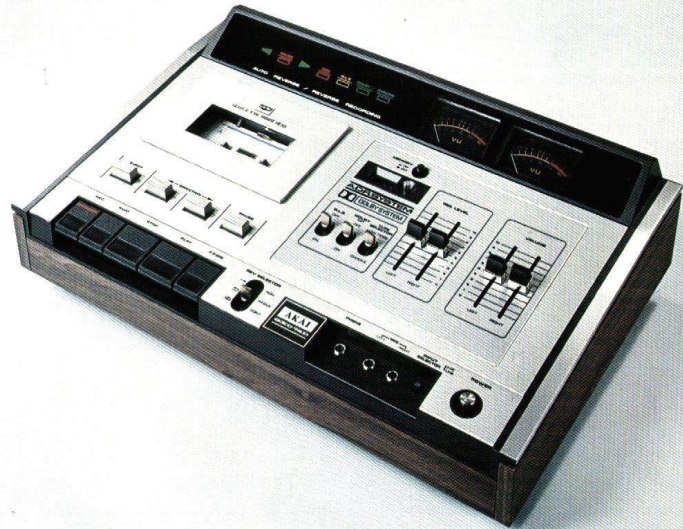

AUTOMATIC & MANUAL REVERSE RECORDING AND PLAYBACK

The GXC-75D employs a new type drive mechanism with drive belt travel in one direction only, providing a unique forward and reverse recording and playback system of which revolutions are perfectly stable for both modes. By utilizing two flywheels and two capstans and positioning the counterclockwise running belt to run under one flywheel for counterclockwise rotation (forward capstan drive) and to run over the top of the other for clockwise rotation (reverse capstan drive), unstable revolutions at the beginning of recording or playback in either direction or when changing from one mode to another is completely eliminated. Automatic or manual reverse operation can easily be effected by operating the Reverse Mode Selector or Manual Reverse Buttons.

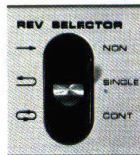

INDIVIDUAL COLOR INDICATOR LAMPS FOR QUICK CONFIRMATION OF CONTROL SETTINGS

Individual color indicator lamps are mounted on the easy-to-see slanted VU Meter panel. Each indicator lights according to the position of the various control switches.

●3-Head Automatic and Manual Reverse Recording and Playback ●Akai's Exclusive Glass & X'tal Ferrite Head ●Unique A.D.R. plus Dolby Noise Reduction System ●Automatic/Manual Reverse Mode Selector ●Attractive Individual Color Indicator Lamps ●Memory Fast Forward and Rewind ●Built-In Over-Level Suppressor ●Automatic Stop Function ●Pause Control for Easy Tape Editing ●Mic/Line Input Selector

Tape Speed 1-7/8 ips
Wow/Flutter Less than 0.1% WRMS
Frequency Response 30-16,000 Hz (±3dB)
(using Chromium Dioxide Tape)
Distortion Less than 1.0% (1 KHz, 0VU)
Signal-To-Noise Ratio Better than 50 dB
Dolby Switch ON; Improves up to 10 dB above 5 KHz
Dimensions 18.1"(W) x 5.8"(H) x 11.9"(D)
(460 x 146 x 302mm)
Weight 17.6 lbs (8.0 kg)

GXC-710D

AMP STYLE CASSETTE
STEREO TAPE DECK

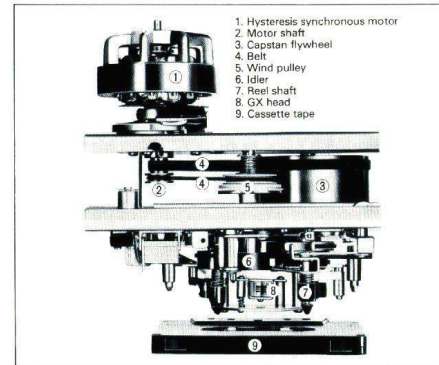

NEW DRIVE SYSTEM AND HEAD PLATE DESIGN COMPLEMENTS GX HEAD PERFORMANCE

The application of Akai's GX (glass and crystal ferrite) Head alone to our quality cassette units brings cassette performance up to average reel-to-reel tape deck standards. However, with this model, Akai has gone even further in designing new mechanisms to complement this superior performance.

As is well known, some of the merits of the GX Head include the elimination of sound drop-out and minimization of high range frequency loss for a wider dynamic range, and improved signal-to-noise ratio. With the new drive system in this Amp Style model, the reel drive belt is completely independent of the flywheel so that unfavorable influence from this part does not exist. This feature results in an amazingly low 0.08% WRMS wow and flutter factor and completely stabilized tape speed. Further, a specially designed head plate which employs a

linear motion ball bearing mechanism provides stable head plate movement and ideal head pressure for perfect and constant head-to-tape contact.

- Akai's Exclusive Glass & X'tal Ferrite Head
- Hysteresis Synchronous Outer-Rotor Motor ●A.D.R. plus Dolby Noise Reduction System, ●New Tape Drive System for Better Stability ●Memory Rewind ●Peak Level Indicator ●One-Touch 3-Position Tape Selector (Fe-Cr/CrO₂/Low Noise) ●MPX Filter circuit for better FM broadcast recording results with the Dolby System ●Tape Loading Safety Mechanism ●Tape Run Indicator ●Full Release Automatic Stop ●Mic/Line Input Selector ●Direct Function Change Control

Tape Speed 1-7/8 ips
Wow/Flutter Less than 0.08% WRMS
Frequency Response 30-17,000 Hz (±3dB)
(using Fe-Cr Tape)
Distortion Less than 1.5% (1 KHz, 0VU)
Signal-To-Noise Ratio Better than 50 dB (+3VU, peak level recording)
Dolby Switch ON; Improves up to 10 dB above 5 KHz
Dimensions 17.3"(W) x 5.6"(H) x 12"(D)
(440 x 142 x 304mm)
Weight 19.4 lbs (8.8 kg)

■ CASSETTE TAPE DECK

GXC-310D

DOUBLE CAPSTAN DRIVE CASSETTE STEREO TAPE DECK

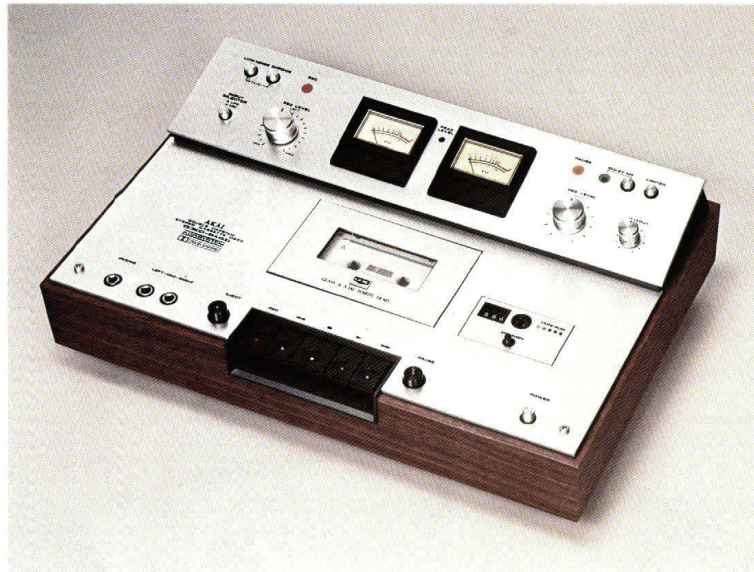

PROFESSIONAL WOW-FLUTTER CHARACTERISTICS WITH CLOSED LOOP DOUBLE CAPSTAN DRIVE SYSTEM

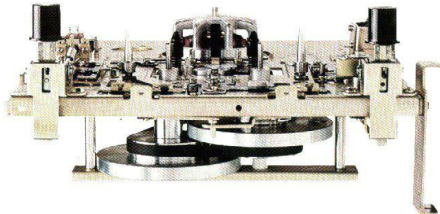

The employment of the refined tape drive system of this model is usually limited to a few professional type open reel models. However, AKAI decided to include this feature in a discriminating number of our cassette models for matchless cassette performance when combined with the other quality mechanisms incorporated in these models.

With this system, the recording/playback head is positioned in the center between two capstans and pinch rollers. This not only results in better head-to-tape contact, but also provides constant tape tension and the section of the tape between capstans is kept free of vibrating interference which may occur outside of the closed area during tape travel.

Functioning integrally with this system is an anti-vibration hysteresis synchronous motor for reduced wow and flutter, modulation interference, and tape speed variation as well as two unusually stout flywheels and flat belts for capstan drive. (When compared with the usual flywheel and V belt system, wow and flutter is small, but rotating energy is increased). Further, the revolutions detector for automatic stop is an electro-magnetic system control lead switch so that the load applied to the reel table is small for even better wow and flutter

characteristics.

Thus, these features result in incomparable tape travel stability and constant tape tension and speed with an amazing wow-flutter specification of 0.07% WRMS.

- Akai's Exclusive Glass & X'tal Ferrite Head
- Closed-Loop Double Capstan Drive Mechanism
- Amazingly Low 0.07% WRMS Wow and Flutter
- Hysteresis Synchronous Outer-Rotor Motor
- A.D.R. plus Dolby Noise Reduction System
- Memory Rewind
- Peak Level Indicator
- Limiter Circuit prevents over-level recording
- Full Release Automatic Stop
- Mic/Line Input Selector
- Pause Control
- Direct Function Change Control
- Tape Selector enables use of Three Top Kinds of Tape

- Tape Speed 1-7/8 ips
- Wow/Flutter Less than 0.07% WRMS
- Frequency Response 30-17,000 Hz (± 3 dB) (using Fe-Cr Tape)
- Distortion Less than 1.5% (1 KHz, 0VU)
- Signal-To-Noise Ratio Better than 50 dB (+3VU, peak level recording) Dolby Switch ON; Improves up to 10 dB above 5 KHz
- Dimensions 17.3" (W) x 5.6" (H) x 11.8" (D) (440 x 142 x 300mm)
- Weight 18.9 lbs (8.6 kg)

■ 8 TRACK CARTRIDGE DECK

GXR-82D

CARTRIDGE STEREO TAPE DECK



- Akai's Exclusive Glass & X'tal Ferrite Recording/Playback Head
- Highly Efficient 2/8 pole Induction Motor for Even Tape Travel
- Convenient Pause Control
- Automatic Stop
- Continuous Playback
- Easy-To-Operate Finger-Tip Control
- Program Selector and Indicator Lamps
- Fast Forward Function

- Tape Speed 3-3/4 ips ($\pm 1.5\%$)
- Wow/Flutter Less than 0.25% RMS
- Frequency Response 40-17,000 Hz (± 3 dB)
- Signal-To-Noise Ratio Better than 47 dB
- Dimensions 13.6" (W) x 5.3" (H) x 10.5" (D) (346 x 135 x 266mm)
- Weight 18 lbs (8.2 kg)

ACCESSORIES

ACM-100: Electret condenser microphone Uni-directional type. Frequency response: 40 Hz to 16,000 Hz. Sensitivity: -68 dB ± 2 dB 0 dB=1 V/ μ bar. S/N ratio: better than 50 dB. Max. sound pressure level: 132 dB s.p.l. Impedance: 2k Ω $\pm 30\%$.

DC-250: Dust cover for use with model GX-280D-SS.

DC-1730: Dust cover for use with model 1730D-SS.

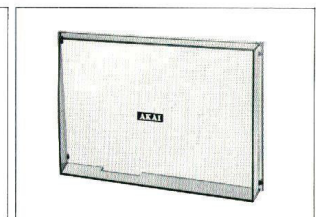
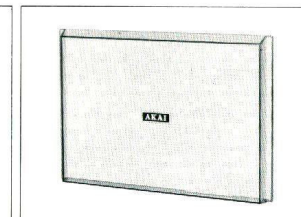
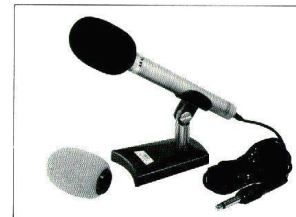



AKAI TRADING CO., LTD.

P.O.Box 12, Tokyo International Air Port
Tokyo, Japan

Tel: (03) 742-5111 Telex: J26261

AKAI INTERNATIONAL GMBH.

6079 Buchschlag bei Frankfurt/Main
Am Siebenstein 4, Tel: 06103/61014-15,
Telex: 4-185332