

Accuphase

STEREO POWER AMPLIFIER

P-350

●4-parallel push-pull output stage delivers quality power of 150 watts \times 2 into 8 ohms●Current feedback circuit topology prevents phase shifts●Bridged mode allows upgrading to true monophonic amplifier●Balanced input circuitry●Two sets of large speaker terminals



Hersteller
Michael Otto

Hersteller
Michael Otto

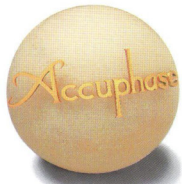

Current feedback circuit topology assures unsurpassed sonic realism and extraordinary detail resolution. 4-parallel push-pull output stage with multi-emitter power transistors delivers 150 watts/channel of quality power into 8 ohms. Bridged mode allows upgrade to a monophonic power amplifier with 420 watts into 8 ohms.

The fundamental requirements of a power amplifier can be summarized into two points. The amplifier must possess the energy resources to deliver a large current to its connected loudspeaker load, and at the same time, it must be capable of reproducing the ambience and true depth of the sound stage with absolute fidelity, even at very low signal levels. In addition to these two basic conditions, the output stage of the amplifier must be designed in such a way that it will not be affected by the considerable fluctuations in loudspeaker impedance, which occur depending on the frequency of the signal.

To fulfill these demands, the P-350 employs multi-emitter type power transistors specially developed for high-power audio applications. These sophisticated devices have excellent frequency response, and outstanding forward-current transfer ratio linearity as well as switching characteristics. With these transistors arranged in a 4-parallel configuration, the P-350 delivers 150 watts of quality power into 8 ohms per channel. By using bridged mode, the P-350 can be turned into a monaural power amplifier with an output of 420 watts into 8 ohms, for even more rich, musical presence and impressive dynamism.

Another design highlight of the P-350 is the "current negative feedback" principle. As opposed to conventional voltage NFB designs, there is virtually no phase shift in the upper frequency range, and frequency response does not change as gain is altered. This circuit topology guarantees ideal amplification characteristics, combining operation stability with excellent frequency response. Phase compensation can be kept at an absolute minimum, since only moderate amounts of NFB are required. This assures outstanding transient response with pulse signals, and the advantages are clearly audible as to superb sonic realism and extraordinary detail resolution.

The basic source of energy for an amplifier is

of course the power transformer and the filtering capacitors. The P-350 features a large 700 VA power transformer and capacitors with ample filtering capacity. This huge power supply block with ample surplus energy greatly contributes to the realization of powerful and dynamic bass reproduction. And to maintain absolute sonic purity, important parts such as input terminals and printed circuit board traces are gold-plated. Externally, the simple and refined design reflects the utterly natural and pure sound of this fine amplifier.

Output stage with 4-parallel push-pull configuration delivers quality power of 210 watts into 4 ohms or 150 watts into 8 ohms per channel
The output stage uses multi-emitter type power transistors specially developed for audio applications and rated for a Power Input to Collector of 100 watts and collector current of 10 ampere. These devices offer extraordinarily wide and flat frequency response, and their forward-current transfer ratio linearity as well as their switching characteristics are excellent. By arranging these transistors in a 4-parallel push-pull configuration, the P-350 achieves ample power output capabilities, providing 210 watts into 4 ohms and 150 watts into 8 ohms per channel. Figure 1 shows the output circuit configuration of the P-350.

Current feedback circuit topology prevents phase shifts
When the gain of an amplifying circuit increases, frequency response, i.e. the bandwidth that can be handled by the amplifier, becomes more narrow. To counter this effect, a commonly employed technique called negative feedback (NFB) routes part of the output signal

back to the input. If phase shift is disregarded, a circuit designed to have high open-loop-gain can apply a high amount of NFB, resulting in the wide frequency response of a closed-loop circuit, as shown in Figure 2.

Conventional amplifiers employ voltage NFB, whereby the output voltage is used for the feedback loop. In the P-350, however, the signal current rather than the voltage is used for feedback. Figure 3 shows the operating principle of this circuit. At the sensing point

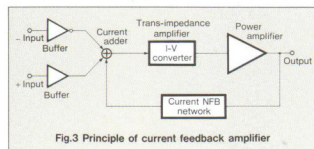

of the feedback loop, the impedance is kept low and current detection is performed. A trans-impedance amplifier then converts the current into a voltage to be used as the feedback signal. Since the impedance at the current feedback point (current adder in Fig. 3) is very low, there is almost no phase shift. Phase compensation therefore can be kept at a minimum, resulting in excellent transient response and superb sonic transparency. With this circuit, there is virtually no change in frequency response when gain is altered.

Figure 4 shows frequency response for different gain settings of the current feedback amplifier. The graphs demonstrate that response remains uniform over a wide range.

Bridged operation mode creates a true monophonic amplifier with 420 watts into 8 ohms
Bridged mode means that the two channels of an amplifier are driven with the same signal voltage but with opposite phase, and their output is combined. The P-350 provides a switch arrangement for bridged operation, which turns the unit into a high-grade monaural amplifier capable of delivering a full 420 watts into 8 ohms. Simply by adding another P-350 to form a stereo amplifier pair, a further improvement in sonic performance can be realized.

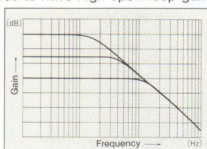

Fig.2 Frequency response with voltage feedback (Response changes when gain is varied)

Balanced connection reliably blocks induced noise

As illustrated by Figure 5, balanced signal transmission means that the output stage of a component supplies two signal lines which have identical voltage but opposite phase. On the input side, these signals are fed to a positive and negative amplifier circuit and then mixed. Since any noise interference that has arisen during transmission will be present in both lines with identical phase, such noise is cancelled out when mixed in the input amplifier leaving only the pure original signal. The longer the cable connections between audio components, the higher is the danger of external noise being introduced into the signal path, which invariably leads to sound quality degradation. The balanced connection principle reliably prevents this danger, by keeping the signal transfer completely free from any kind of interference.

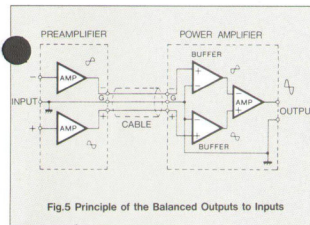

Fig.5 Principle of the Balanced Outputs to Inputs



In the P-350, as shown in Figure 6, the balanced signal is connected directly to inverting (+) and non-inverting (-) input stages, resulting in ideal balanced operation.

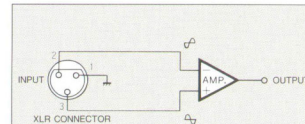

Fig.6 Balanced-Input Circuit of the P-350

Gold-plated PCB traces

High-purity copper is commonly used in audio components for signal path lines. The P-350 goes one step further by providing gold-plating for printed circuit board traces as well as for the input jacks. This approach results in a distinct sonic improvement.

Robust power supply with large power transformer and high filtering capacity

In any amplifier, the power supply plays a vital role as the source of energy for the entire unit.

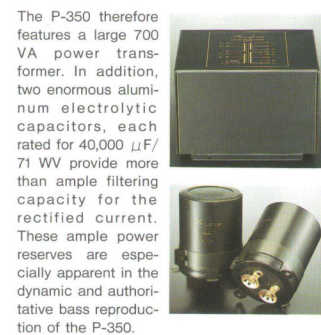

Large speaker terminals compatible with banana plugs

The oversized speaker terminals are made of extruded high-purity brass material. The binding posts accept even very heavy-gauge speaker cable, and it is also possible to insert banana plugs. Two switchable sets of outputs are provided, allowing independent use or bi-wiring (supplying the same signal via dual leads to speakers with separate high-frequency and low-frequency inputs).

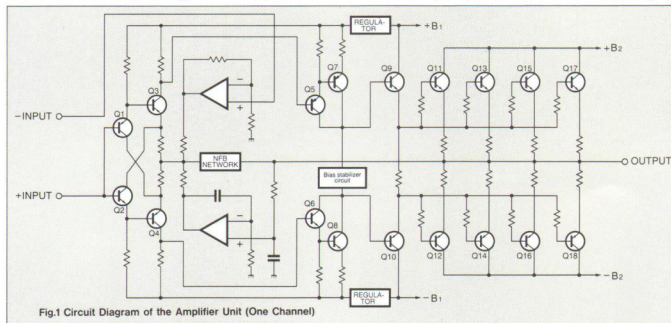
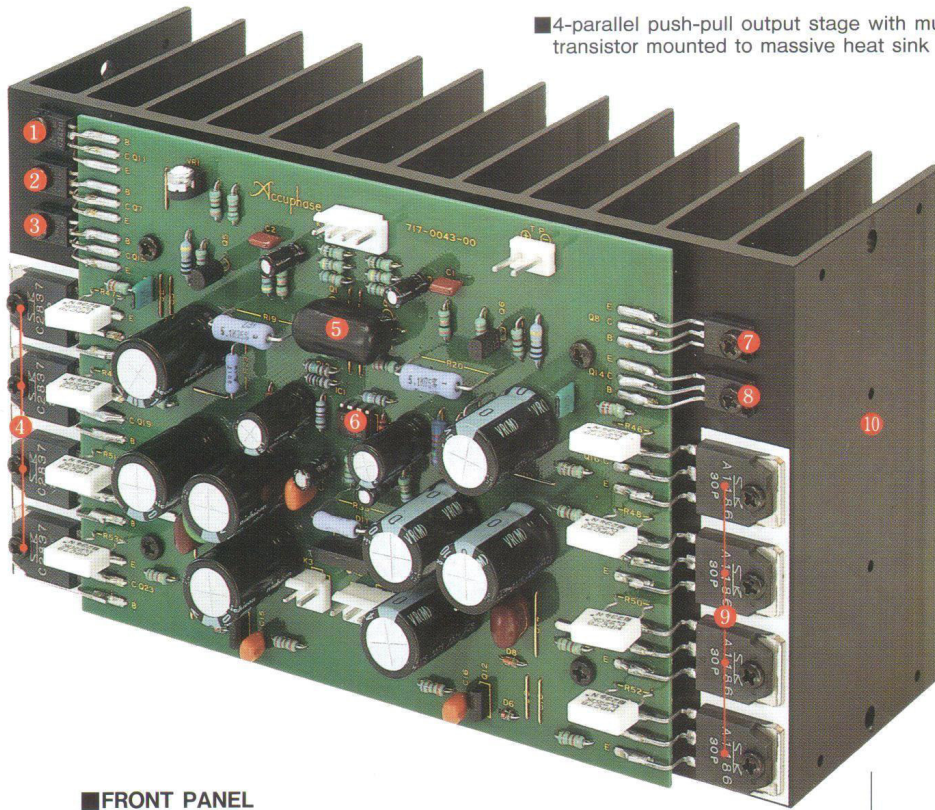

Fig.1 Circuit Diagram of the Amplifier Unit (One Channel)



© beim Hersteller
Armin Michael Otto

■ 4-parallel push-pull output stage with multi-emitter power transistor mounted to massive heat sink (one channel)



- 1 Temperature sensor transistors for bias stabilizer circuit
- 2 Class A PNP transistor predriver
- 3 NPN transistor driver
- 4 4-parallel NPN output transistors
- 5 Current feedback input buffer
- 6 DC servo OP amplifier
- 7 Class A NPN transistor predriver
- 8 PNP transistor driver
- 9 4-parallel PNP output transistors
- 10 Large aluminum heat sink

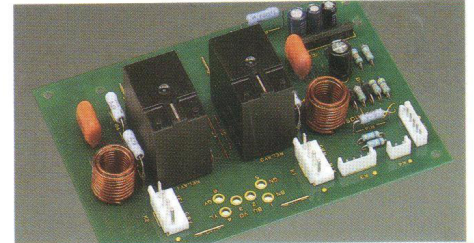

High-current output relay and protection circuit assembly

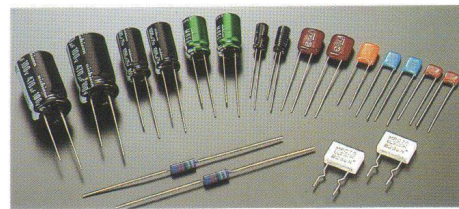

P-350 parts selected for sonic excellence

■ FRONT PANEL

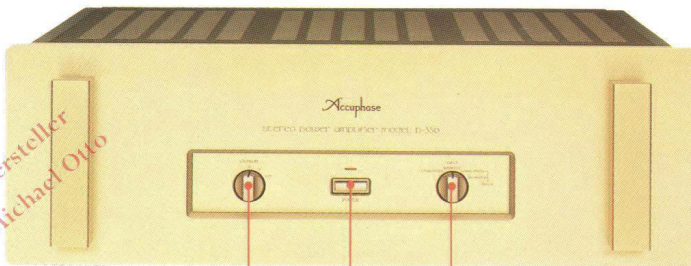

- 1
- 2
- 3

■ REAR PANEL

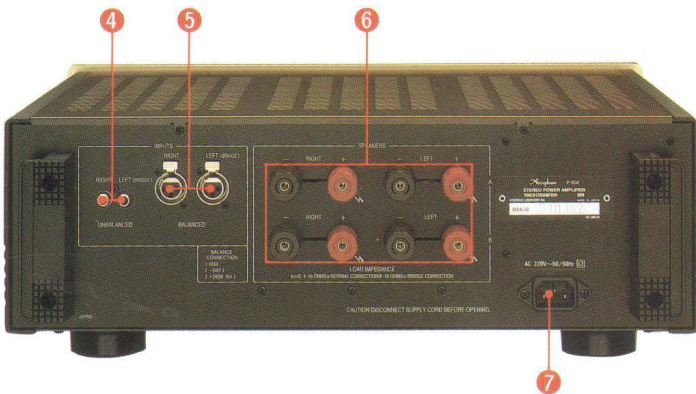

- 1 Speaker selector: A,B,A+B
- 2 Power switch
- 3 Input/bridge selector
Unbalanced, Balanced, Bridge Unbalanced, Bridge Balanced
- 4 Unbalanced input jack
- 5 Balanced input connectors.
(1) Ground
(2) Inverted(-)
(3) Non-inverted(+)
- 6 Left and right channel output terminals for speaker systems A and B
- 7 AC connector (for supplied power cord)

Guaranteed Specifications

*Guaranteed specifications are measured according to EIA standard RS-490

Continuous Average Output Power (20 to 20,000 Hz)	Stereo mode (both channels driven) 210 watts per channel into 4-ohm load 180 watts per channel into 6-ohm load 150 watts per channel into 8-ohm load Monophonic mode (bridging connection) 420 watts into 8-ohm load 300 watts into 16-ohm load
Total Harmonic Distortion	Stereo mode (both channels driven) 0.02%, with 4-to 16-ohm load Monophonic mode (bridging connection) 0.02%, with 8-to 16-ohm load
Intermodulation Distortion	0.02%
Frequency Response	20 to 20,000 Hz, +0 dB, -0.2 dB (for rated continuous average output) 0.5 to 160,000 Hz, +0 dB, -3.0 dB (for 1 watt output)
Gain	28.0 dB (in stereo and monophonic mode)
Output Load Impedance	4 to 16 ohms stereo mode 8 to 16 ohms in monophonic mode (bridging connection)
Damping Factor	360 in stereo mode 180 in monophonic mode (bridging connection)
Input Sensitivity (with 8-ohm load)	Stereo mode 1.38V (for rated continuous average output) 0.11V (for 1 watt output) Monophonic mode (bridging connection) 2.31V (for rated continuous average output) 0.11V (for 1 watt output)
Input Impedance	Balanced: 40 k ohms Unbalanced: 20 k ohms
Signal-to-Noise Ratio (A-weighted)	120 dB (input short circuit, rated continuous average output)
Power Requirements	100V, 120V, 220V, 230V, 240V (Voltage as indicated on rear panel) AC, 50/60 Hz
Power Consumption	65 watts at zero signal input 300 watts in accordance with IEC-65
Maximum Outline Dimensions	475mm (18-23/32") width 170mm (6-7/10") height 435mm (17-1/10") depth
Weight	23.6kg (52 lbs.) net 28.6kg (62.3 lbs.) in shipping carton

*Specifications and design subject to change without notice for improvements.

