

Accuphase

STEREO POWER AMPLIFIER

D-300X

- 150W/ch. realized with Parallel Push-pull Output Stage
- Direct-coupled Amp. with DC Servo Controlled Circuit
- Built-in Bridging Connection Circuit

© beim Hersteller
Archiv Michael Otto
HiFi-Classic.de



Employing the latest bipolar transistors which have superior high frequency characteristics in its parallel push-pull output stages, the Accuphase P-300X is a stereo power amplifier which can deliver ample power of 150W/ch into 8 ohms.

Complementary-symmetry, push-pull circuitry, a consistent practice with Accuphase since the widely successful P-300, is used in all stages, but the P-300X also introduces a newly developed "Cascode Bootstrap Differential Amplifier" at its input, which has further improved performance characteristics.

In its power supply which is the most vital section for any power amplifier, the P-300X employs separated, independent windings of the power transformer secondary for each channel.

The P-300X incorporates other significant functions, such as a built-in Bridging Circuit which, by simple switch action, can transform the P-300X into a powerful 400W monophonic power amplifier that can supply ample power to a dynamic sub woofer system, or effectively contributes to upgrading the system with more power by adding another P-300X.

It also has Input/Output connectors hidden behind the front Sub Panel for convenience in testing various audio equipment.

In designing the P-300X, Accuphase attached the greatest importance to give it the capability to deliver a deeper, more vigorous description of music which contains greater detail and background atmosphere.

1 PARALLEL PUSH-PULL OUTPUT STAGE DRIVEN BY MOS FET DRIVER STAGE

The amplifier circuit diagram below shows that MOS FETs (Metal-Oxide Semiconductor Field Effect Transistors) are used in the driver stage and bipolar transistors, which are the latest wide frequency types, are used in the output stage. The use of MOS FETs in the primary stage stabilizes the bias voltage of the output stage, and eliminates the need for emitter stabilizing resistors. This has prevented switching distortion, since the bias of the output transistor is never cut off even at peak output levels.

Another advantage of using MOS FETs in the driver stage is that because of their very high input impedance, the operation of the pre-driver stage is greatly stabilized, which also contributes to higher overall performance.

2 CASCODE PUSH-PULL PRE-DRIVER GREATLY IMPROVES HIGH FREQUENCY PERFORMANCE

The pre-drive stage which must supply large voltages and high current to the driver stage is most vital as it governs the performance of the entire amplifier. Wide band amplification is achieved in this stage of the P-300X by using transistors in cascode connection.

Q13 to Q16 of the diagram shows the cascode connections of the pre-driver stage. Ample high gain is achieved with common-emitter connection of Q13Q14, and high amplitude voltage with common-base connected transistors Q15Q16 which have resulted in superior high frequency characteristics void of Miller effects. The cascode connection of transistors in which one pair handles large currents, and the other high amplitude voltages, has completely solved the characteristics shortcomings of pre-driver stages.

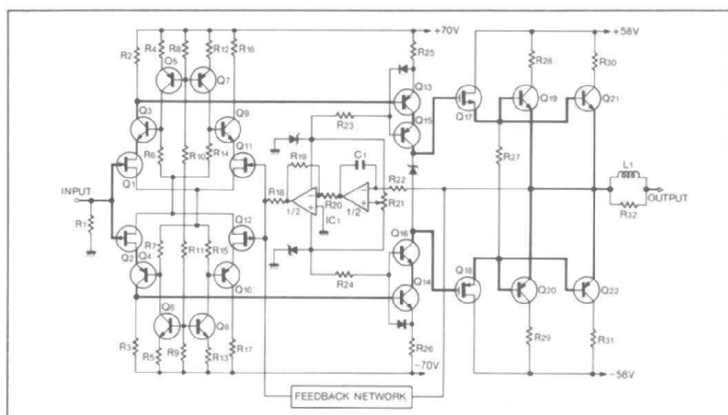

Diagram of Cascode Bootstrap connection Input stage and Parallel Push-pull Output stage

3 CASCODE BOOTSTRAP DIFFERENTIAL PUSH-PULL INPUT STAGE

The differential amplifier circuitry in the input section consists of Q1 to Q11. Its input stage employs P-Channel and N-Channel FETs in push-pull arrangement which is cascode connected to the next stage consisting of Q3 Q4. The source electrode of Q1 is connected to the base electrode of Q4 through R7, and the source electrode of Q2 is connected to the base of Q4 through R6 in a bootstrap pattern.

Very stable wideband amplification was achieved by employing this cascode bootstrap circuitry, which not only contributed to high gain and improved high frequency characteristics, but also practically eliminated any increase in distortion when input impedance is raised (as when volume control is adjusted).

Test data on actual distortion characteristics of the P-300X appear on the next page. It shows that intermodulation distortion and transient intermodulation distortion are completely absent, and confirms that overall distortion characteristics are very close to the ideal.

4 DC SERVO CONTROL CIRCUITRY

Input capacitors were eliminated by employing FETs at the input as can be seen from the circuit diagram. This would mean that DC components in the input signal would also be amplified, so that any DC leakage from an associated preamplifier would pose the risk of damaging the speakers.

Such direct currents must be blocked in order to protect the speakers. The P-300X has a DC Servo Control circuitry which not only effectively blocks such direct current, but it also neutralizes any DC drift that may occur in the power amplifier circuitry itself. The IC in the circuit diagram shows this DC Servo Control circuit.

5 HIGH PERFORMANCE POWER SUPPLY FEATURES SEPARATE POWER SOURCES FOR EACH CHANNEL

The importance of a power amplifier's power supply which must deliver rapidly changing energy to the speakers increases in direct relation to the quality of high grade amplifiers. The power supply must not only have sufficient power supplying capacity, but it must not cause interchannel interference.

The P-300X has a high performance power supply which completely eliminates such possibilities by using separated secondary winding of the power transformer which lead to independent rectifiers and filter capacitors that make up a separate, exclusive power source for each channel.

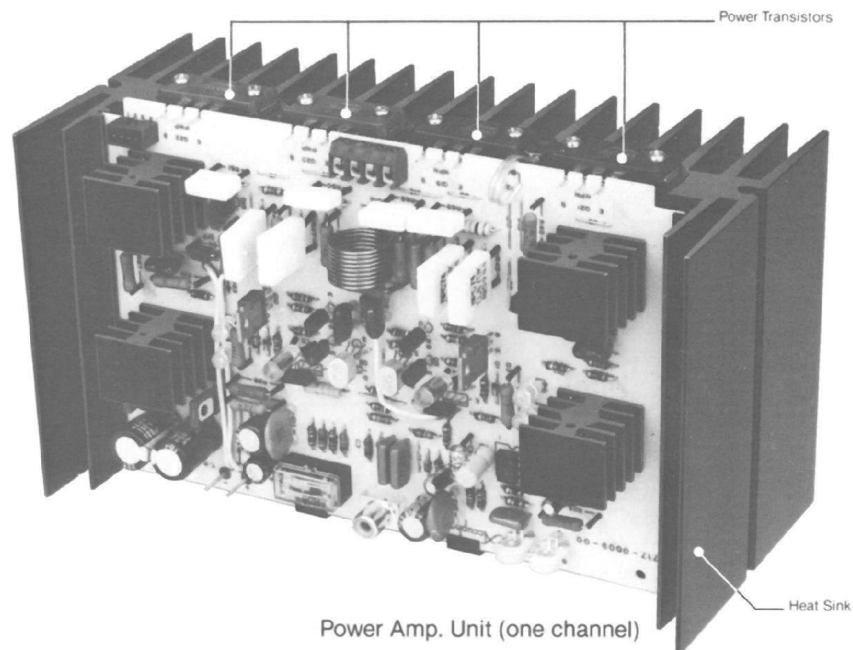

Power Amp. Unit (one channel)

Accuphase P-300X

STEREO POWER AMPLIFIER

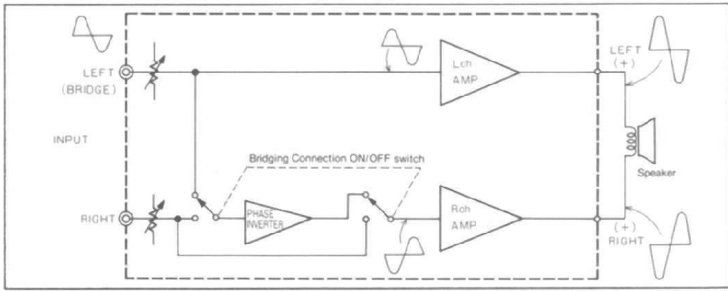

Schematic diagram of Bridging Connection

6 POWER BRIDGING CIRCUITRY TURNS IT INTO A 400W (at 8 ohms) MONOPHONIC AMPLIFIER

The P-300X has a built-in Bridging Connection circuit which can transform its stereo power amplifier system into a powerful 400 watt (at 8 ohms) monophonic amplifier simply by switch operation.

This bridging connection causes amplifiers in both channels to work in unison to double the voltage output to the speakers and increase power output as shown in the diagram above. It also helps to cancel out distortion and improve its characteristics. The additional power upgrades systems with more power or effectively enhance sub woofer system.

7 1dB STEPPING ATTENUATOR

It is necessary to control the input level of a power amplifier that is used in a separate amplifier system in order to accommodate differences in speaker efficiency, and pre-amplifier gain. The P-300X has a 20-step attenuator which provides attenuation up to -20dB in one dB steps. It enables accurate input level adjusts easily for multi-amplification systems as well.

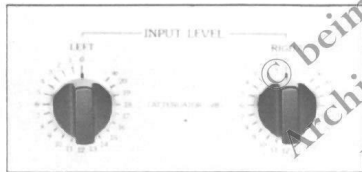

8 PEAK LEVEL METER WITH "PEAK HOLD" FEATURE

A very helpful monitoring aid is provided in the Power Level Meter. it is a logarithmic type peak level meter which permits direct reading of power output (at 8 ohms) on its continuous scale that covers the entire power range. It also has dB indications for direct reading. In addition it has a "Peak Hold" feature which holds the pointer at peak level for a sampling period of three seconds by using the Meter Function switch.

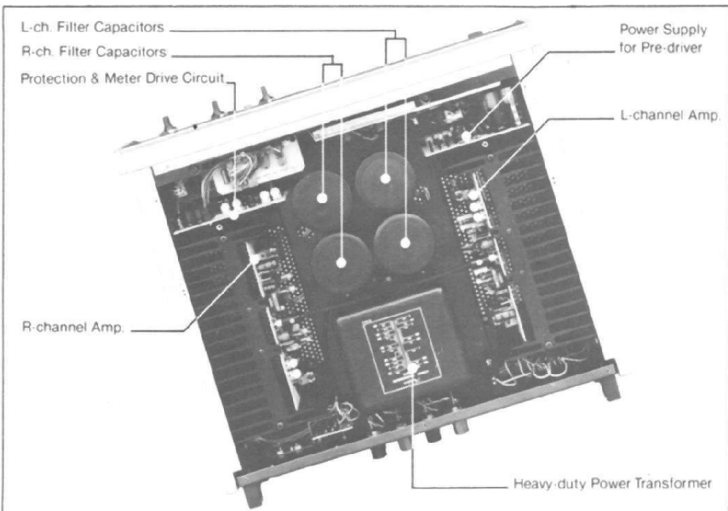
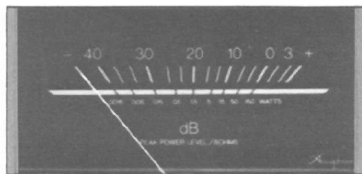

Internal View

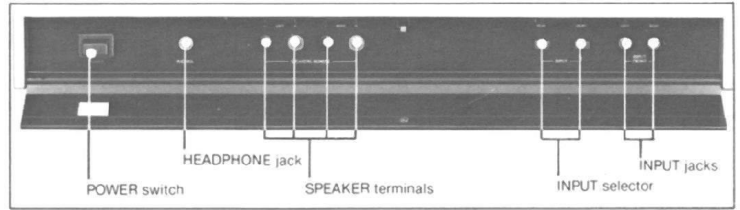

Functions in the Sub Panel

9 INPUT/OUTPUT TERMINALS HIDDEN UNDER THE SUB PANEL

The P-300X allows switch selection of three pairs of outputs and two pairs of inputs. One pair each of the above connectors is hidden under the front Sub Panel, which makes it very convenient for testing audio equipment.

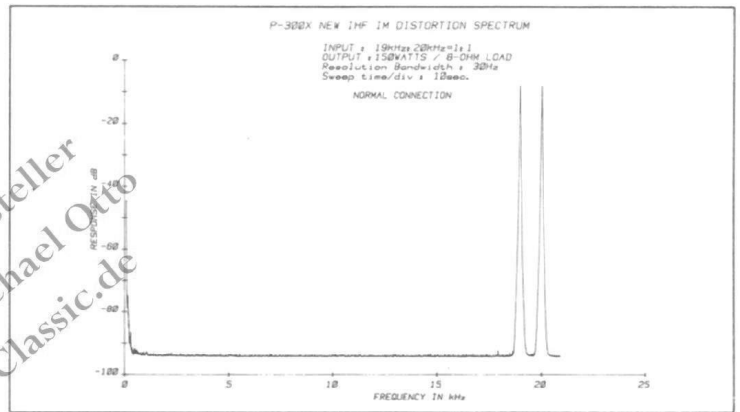

The above data shows the spectrums of intermodulation distortion for the P-300X as measured by the new IHF measurement method. Amplitudes of a 19kHz and 20kHz input signals are shown at the right side. Any intermodulation created by these two signals would appear as spectrum peaks at 1kHz intervals, the frequency difference between the two signals, across the frequency bandwidth. This data shows them to be hardly noticeable, confirming that IM distortion is less than -93dB (0.0022%).

Another form of IM distortion would appear at 39kHz, the sum of the two input signal frequencies (19 + 20 = 39kHz). Such a distortion, even if it existed, would be inconsequential because it is far beyond the audible range. In the P-300X, this form of IM distortion is also less than -93dB.

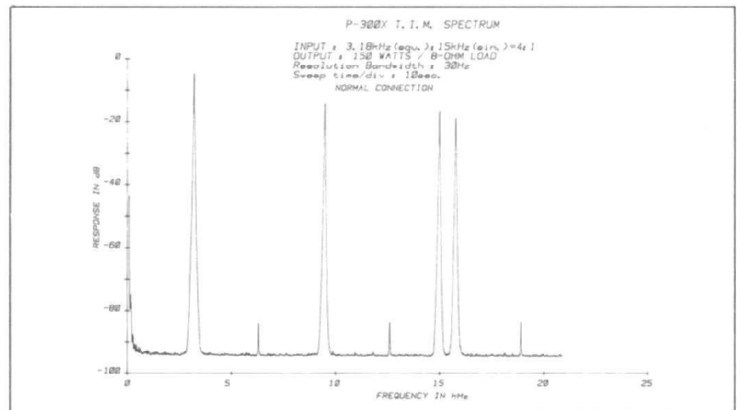

The above data shows the spectrum characteristics of transient intermodulation distortion for the P-300X when two mixed input signals, a 3.18kHz square wave and a 15kHz sine wave, are used. Since harmonics of square waves appear almost infinitely at odd number multiples, for example in this case at 9.54kHz (3rd harmonic) 15.9kHz (5th harmonic), they can create, together with the 15kHz input sine wave, intermodulated spectrums at frequencies where input signals are absent. For example, if the third harmonic of the 3.18kHz square wave (9.54kHz) and the 15kHz input signal intermodulate, a spectrum can appear at the difference of their frequencies or 5.46kHz (15 - 9.54 = 5.46kHz). However, the above data shows no spectrum above -93dB at that frequency which confirms that TIM distortion is less than 0.0022%.

Accuphase P-300X

STEREO POWER AMPLIFIER

GUARANTY SPECIFICATIONS

PERFORMANCE GUARANTY:

All Accuphase product specifications are guaranteed as stated.

CONTINUOUS AVERAGE POWER OUTPUT: (New IHF Standard)

Both channels driven, from 20Hz to 20,000Hz with no more than 0.01% total harmonic distortion;

NORMAL CONNECTION; (both channels driven)

200 watts per channel, min. RMS, at 4 ohms

150 watts per channel, min. RMS, at 8 ohms

75 watts per channel, min. RMS, at 16 ohms

BRIDGE CONNECTION; (monophonic)

400 watts, min. RMS, at 8 ohms

200 watts, min. RMS, at 16 ohms

TOTAL HARMONIC DISTORTION:

Both channels driven, from 20 Hz to 20,000Hz at any power output from 1/4 watt to rated power;

NORMAL CONNECTION; (both channels driven)

0.01 % max., at 4 ohms

0.005% max., at 8 ohms

0.005% max., at 16 ohms

BRIDGE CONNECTION; (monophonic)

0.02% max., at 8 ohms

0.02% max., at 16 ohms

INTERMODULATION DISTORTION: (New IHF Standard)

Will not exceed 0.003% at rated power output

FREQUENCY RESPONSE: (New IHF Standard)

20Hz to 20,000Hz, +0, -0.2dB for rated output at the maximum level control

0.4 Hz to 250,000Hz, +0, -3.0dB for 1 watt output at the maximum level control

0.4 Hz to 120,000Hz, +0, -3.0dB for 1 watt output at -6dB attenuation

VOLTAGE AMPLIFICATION IN DECIBELS: 27.8dB at NORMAL CONNECTION 33.7dB at BRIDGE CONNECTION

INPUT SENSITIVITY AND IMPEDANCE:

NORMAL CONNECTION;

1.4V, 50k ohms, for rated output at the maximum level control

0.11V, 50k ohms, for 1 watt output (New IHF Standard)

BRIDGE CONNECTION;

1.17V, 50k ohms, for rated output at the maximum level control

0.06V, 50k ohms, for 1 watt output (New IHF Standard)

OUTPUT LOAD IMPEDANCE: 4 to 16 ohms at NORMAL CONNECTION 8 to 16 ohms at BRIDGE CONNECTION

DAMPING FACTOR: (New IHF Standard at 50Hz)

150 at NORMAL CONNECTION

75 at BRIDGE CONNECTION

A-WEIGHTED SIGNAL-TO-NOISE RATIO:

NORMAL CONNECTION;

120dB below rated output, inputs shorted

100dB at 1 watt output (New IHF Standard)

BRIDGE CONNECTION;

110dB below rated output, inputs shorted

90dB at 1 watt output (New IHF Standard)

STEREO HEADPHONE: Low Impedance type

SUBSONIC FILTER: 17Hz cutoff, 12dB/oct

POWER LEVEL METER: Logarithmic Scale Peak Level indication of the dynamic range from -40dB to +3dB with Peak-Hold circuit, calibrated to read 0dB at 150 watts into 8 ohms load.

SEMICONDUCTOR COMPLEMENT: 42 Tr's, 12 FET's, 7 IC's and 61 Di's

POWER REQUIREMENT: Voltage Selector for 100V, 117V, 220V and 240V 50/60Hz operation

POWER CONSUMPTION: (NORMAL CONNECTION)

80 watts at zero signal output

550 watts at rated power output into 8 ohms load

DIMENSIONS: 445mm (17-1/2 inches) width, 160mm (6-5/16 inches) max. height, 373mm (14-11/16 inches) depth

WEIGHT: 22.5kg (49.5 lbs) net

27.0kg (59.4 lbs) in shipping carton

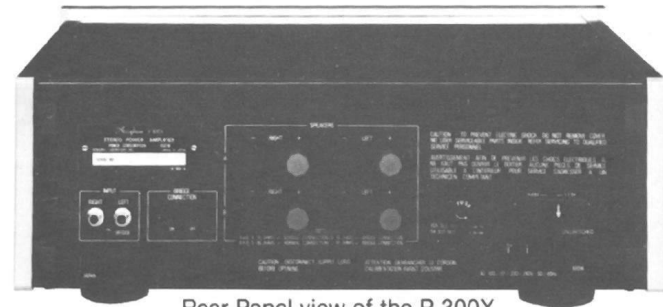

Rear Panel view of the P-300X

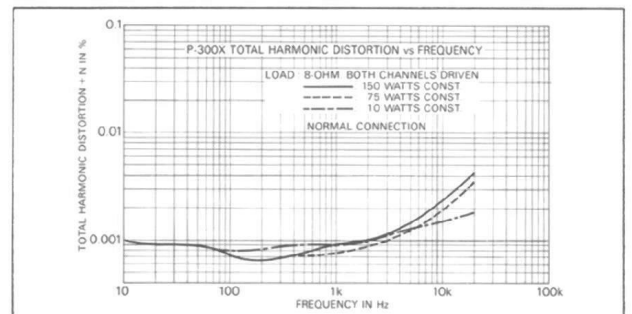
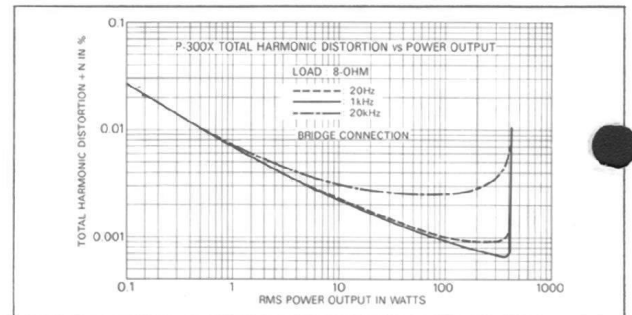
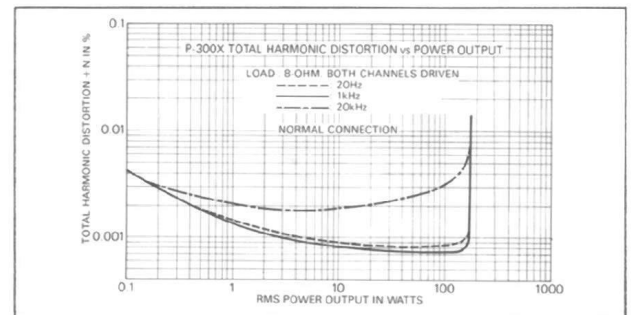
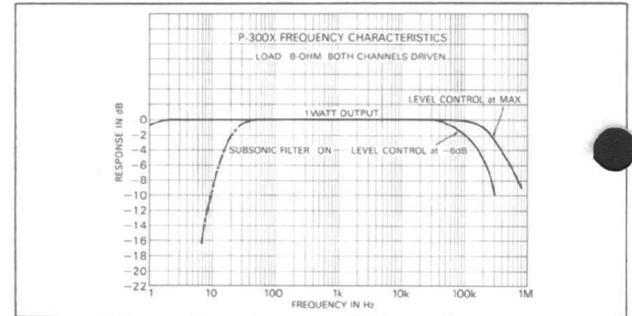

© beim Hersteller
Archiv Michael Otto
HiFi-Classic.de