

# Accuphase

## STEREO POWER AMPLIFIER

# P-300V

- Ten parallel push-pull output stages outputting 180 W for both channels (at 8 ohms)
- Low load-impedance design
- DC servo directly coupled
- Also serve as 560-W (at 8 ohms) monophonic amplifier when bridge-connected
- Balanced input provided

eller  
Michael Otto

© beim Hersteller  
Archiv Michael Otto



# The Long-run Selling Series of Accuphase Stereo Power Amplifiers. Push-pull circuit. Ten parallel push-pull power stages guarantee 180 W/ch as stereo amp, and 560

The first models introduced by Accuphase in August 1973 after the founding of the company were the power amplifier P-300 and the preamplifier C-200. Having undergone three model changes, these components are still being built today. They are regarded as the foremost products in the category of separate amplifiers and have received awards too numerous to mention. For well over ten years, many audiophiles all over the world have made these products their superior choice, a feat that hardly any other amplifier can lay claim to. An important reason for this popularity is the

fact that model changes for Accuphase mean continuity - preserving the essence of a product and its best features - combined with innovation - making latest technology and selected components work towards further improved sound quality and performance. A solid technological foundation and extensive know-how accumulated over the years provide the basis for Accuphase excellence.

The all-stage push-pull configuration developed by Accuphase traditionally forms the base of all our amplifiers. Cascode connection is realized up to the drive

stage, for outstanding high-frequency performance. The overall characteristics of this amplifier assure sound reproduction of the highest order. The drive stage operates in class A, and MOS FETs are used as drivers in the output stage, for impeccable resolution of the musically important low-level signals.

In the age of digital program sources, an amplifier must be able to provide a speaker drive signal that faithfully duplicates even extreme changes in the input waveform. It is a well known fact that a loudspeaker is not just a resistive but also a reactive load,

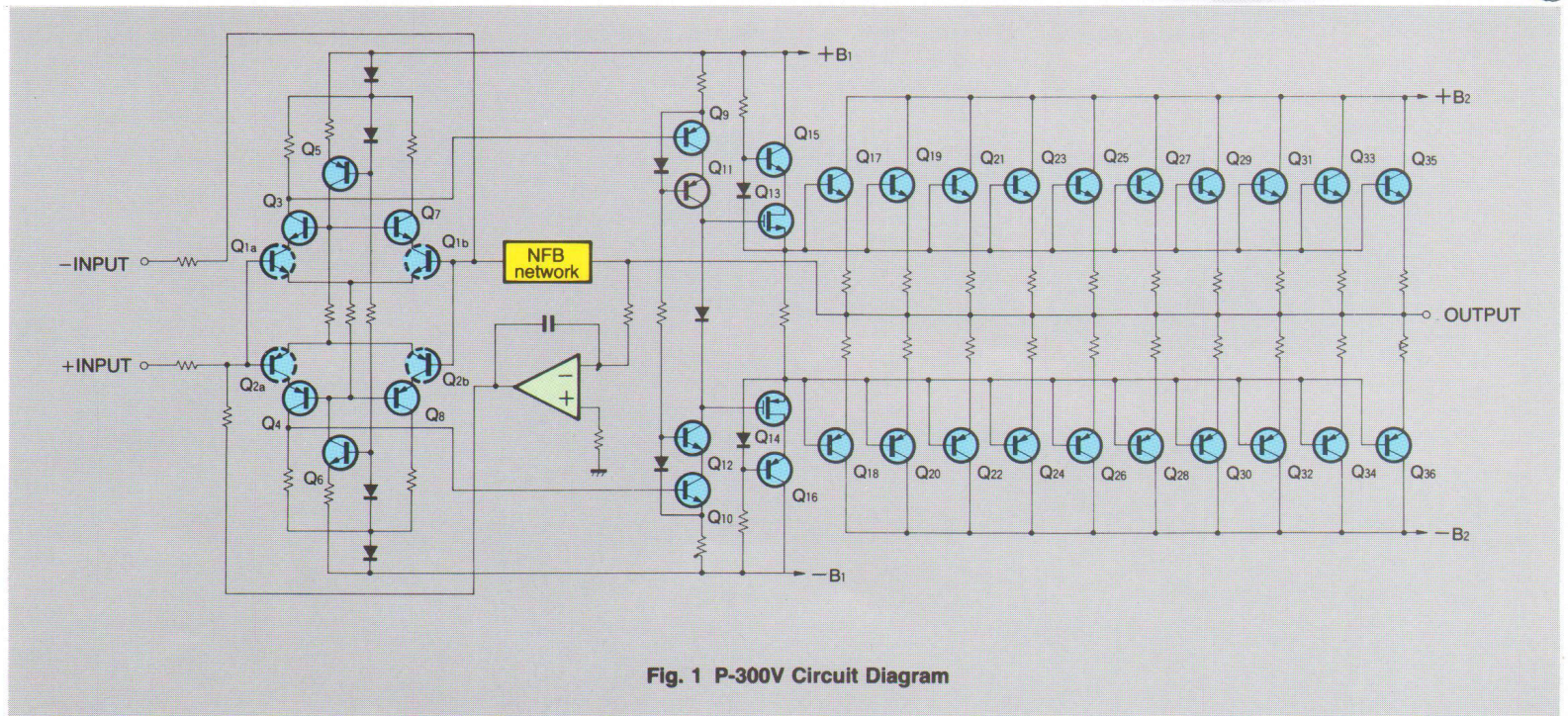
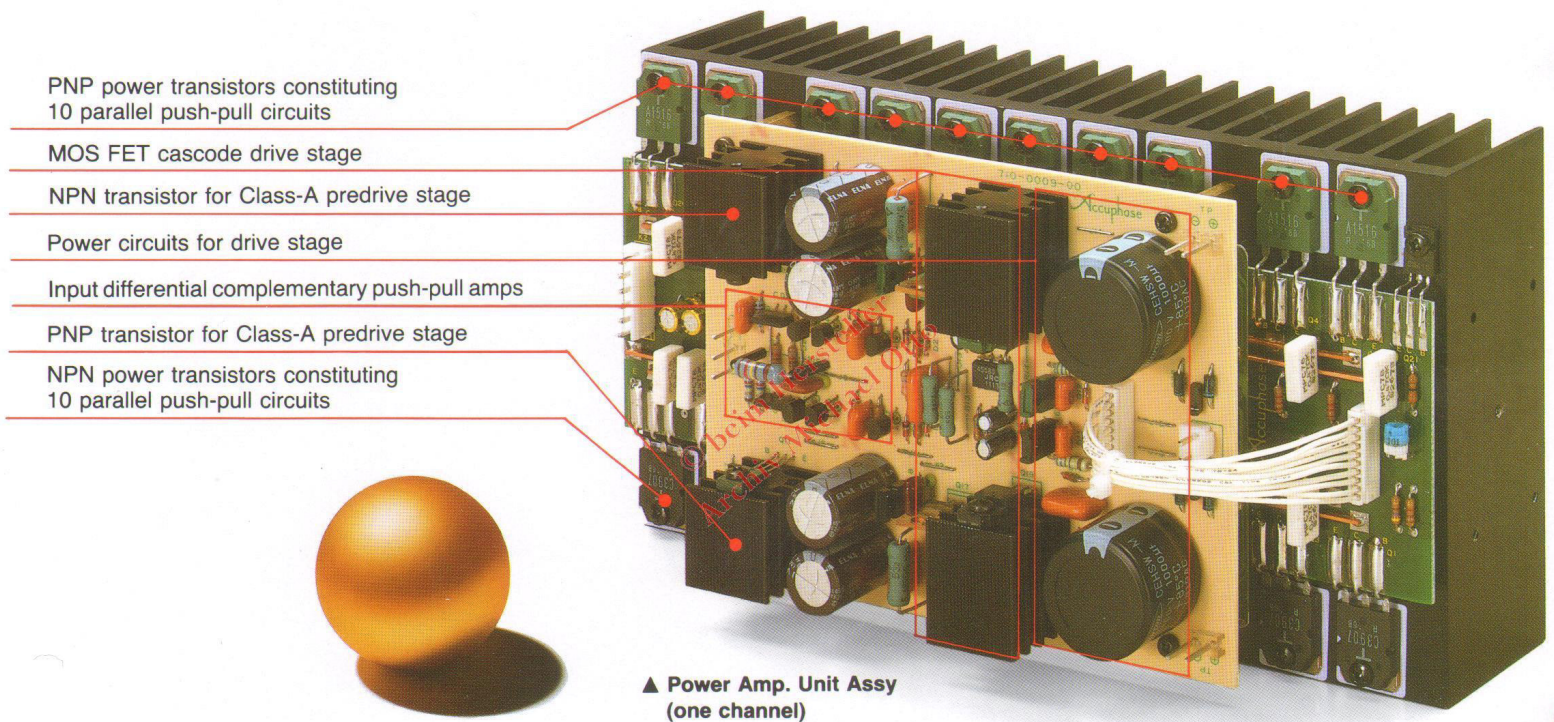

# Circuits on all stages. DC servo directly coupled throughout.

## W (at 8 ohms) as monophonic amp. Even 2-ohms loads can be fully driven.

and its impedance changes considerably with frequency. This poses severe demands on the drive capability of the amplifier, especially in the low-impedance range.

The output stage of the P-300V draws its energy from an extra large toroidal transformer. In each channel, 20 transistors with a maximum power dissipation (Pc) rating of 130 watts each are used in a parallel push-pull configuration. This assures effortless speaker drive even under the most demanding low-impedance conditions. The power rating is 180 watts per channel into 8 ohms and an amazing 350 watts per channel into 2 ohms (20 to 20,000 Hz, THD 0.01%). Even loads as low as 1 ohm can be safely driven by the P-300V, something previously unheard of for an amplifier in this class.

The possibilities of the P-300V also include bridged operation for even higher power. As a monophonic amplifier, it delivers 560 watts into 8 ohms and 700 watts into 4 ohms.

The P-300V offers a balanced input circuit, a principle that is being advocated by Accuphase since several years. A sophisticated switching design of the differential input provides balanced and unbalanced input capability, while keeping circuit topology simple, which is desirable for utmost signal purity.

The external appearance follows the elegant Accuphase tradition. The visual appeal of this amplifier is further enhanced by its side panels of natural wood.

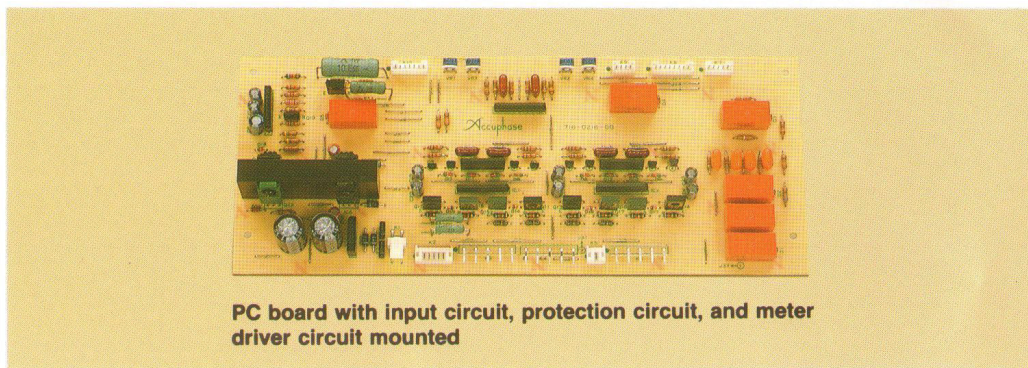

PC board with input circuit, protection circuit, and meter driver circuit mounted

### 1 "10-parallel" push-pull output stage offers ample power reserves: 180 watts per channel into 8 ohms, 350 watts per channel into 2 ohms

The output stage consists of 10 parallel push-pull circuits each of which is made up of a pair of wide-band transistors each having a maximum power dissipation (Pc) of 130 W. This means that a total of 20 transistors are used to form the output stage, and that the total power dissipation is 2,600 watts per channel. Assuming the power efficiency at the output stage to be 70%, the theoretical upper-limit output reaches as high as 3,700 W. This enormous current capacity is called upon to supply the rated output power of 180 watts per channel (20 to 20,000 Hz, THD 0.01%). The ample reserves of this design ensure effortless speaker drive and highly linear operation even with very low load impedances. Under such load conditions, voltage is not critical, but current requirements are considerable, because the current is inversely proportional to the impedance.

To ensure rock-stable current capability, the "10-parallel" configuration with 20 transistors was chosen. The result of this luxurious design is clean power of 180 watts per channel into 8 ohms, and 350 watts per channel into 2 ohms. Even loads as low as 1 ohm can be safely driven by the P-300V, something previously unheard of for an amplifier in this class.

### 2 Bridged operation creates a monophonic power amplifier with awesome power: 560 watts into 8 ohms and 700 watts into 4 ohms

In bridged connection, as Fig. 2 shows, the same signal is supplied to both channels of the amplifier with inverted phase, and the speaker load is connected between the two outputs. This provides twice the power available into 4 ohms in stereo operation.

In conventional designs, a phase inverting circuit is necessary in one channel, which increases circuit complexity. But the approach taken in the P-300V is different. The polarity of the two differential input circuits is used in combination with ingenious connection rerouting as shown in Fig. 3, so that the signal enters the circuits with opposite phase. No additional amplifier circuitry is necessary, and superior signal purity is maintained.

The output power of 560 watts into 8 ohms and 700 watts into 4 ohms in bridged operation provides sound with dramatic impact and dynamic authority under any condition.

### 3 Balanced input offers perfect protection against external noise

In addition to the regular unbalanced 20-kilohm input jacks (phono jacks), a balanced 40-kilohm

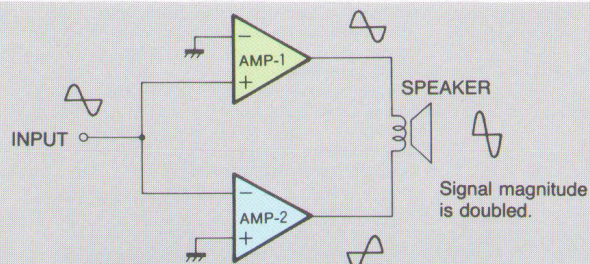

Fig. 2 Operating Principle of Bridge Connection

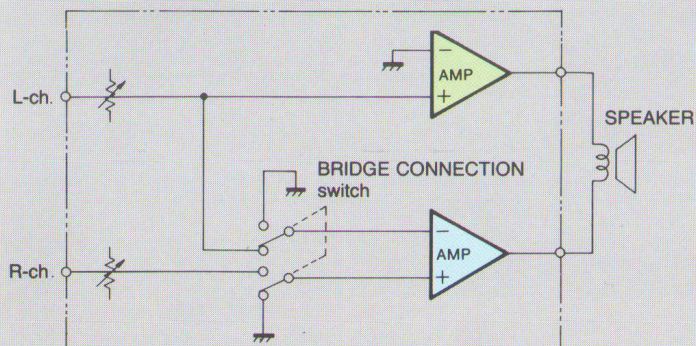

Fig. 3 Bridge Connection (The switch position indicates the bridge connection.)

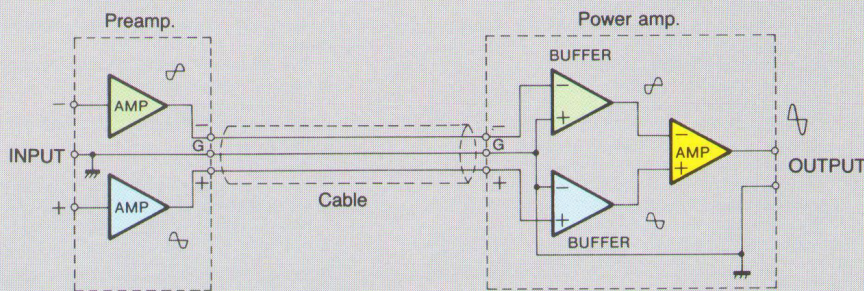

Fig. 4 Operating Principle of Balanced Network

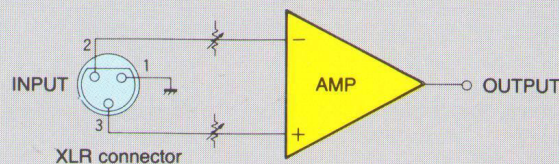
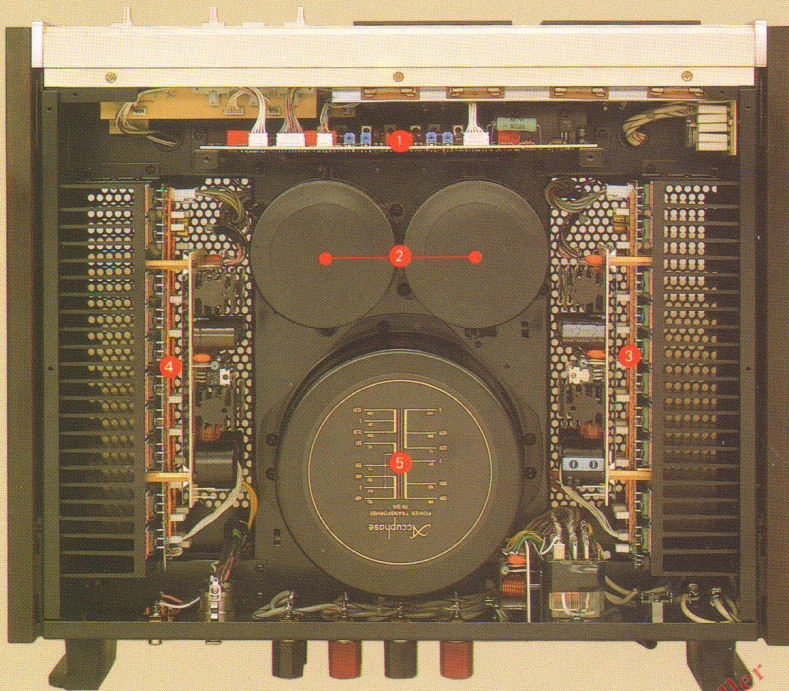

Fig. 5 Balanced Input Circuit

# Accuphase P-300V

STEREO POWER AMPLIFIER



- 1 PC board with input circuit, protection circuit, and meter driver circuit mounted
- 2 Two 40,000- $\mu$ F filter capacitors
- 3 L-channel power amp unit assy
- 4 R-channel power amp unit assy
- 5 Heavy-duty toroidal power transformer

◀ Internal layout

input is also provided, so that a balanced output of any impedance can be connected with 3P-XLR type connectors conforming to the international standard.

The operating principle of a balanced network, which consists of balanced outputs and balanced inputs, is as shown in Fig. 4. A positive and a negative voltage whose phases are completely opposite to each other (i.e., shifted by 180°) are sent out. These voltage signals are respectively received by a positive and a negative amplifier. The important point to be noted is that the noise components of both the signals, which are generated in the cables, are in phase. Consequently, they cancel out and diminish when mixed by the input amplifier.

This is especially useful when long cable runs between components are necessary. The balanced input principle completely shuts out any externally induced noise, for utterly pure and undiluted signal transmission.

In the balanced input section of the P-300V, the signal is directly applied to the positive and negative input of the differential circuit, as Fig. 5 shows, thereby assuring ideal operation characteristics. This configuration requires separate level controls for the positive and negative signal path. High-precision 1-dB step attenuators with superior tracking are used, and the circuit is designed to ensure perfectly flat frequency response, regardless of the position of the level controls.

## 4 Cascade push-pull and MOS FET cascode push-pull circuitry driver stage improves high-frequency characteristics and harmonic distortion of low-level signal

The dynamics of strong sound and the clean details of pianissimo both are indispensable

and inseparable effects to reproduce true-to-life sound for the listener. However, especially for a high-power amplifier, it is difficult to embody these antipodal effects at the same time. Nevertheless, Accuphase's technology has made it possible to realize these effects in a single device. To dispose of the switching distortion at low output which may occur in the output stage, each of the PNP and NPN elements is set strictly to the operating points, avoiding cut off (no current flow) by input signal. The predriver stage that drives the final stage of the amplifier circuit employs an arrangement of MOS FETs equivalent to non-switching class A driver circuit and comprises cascode push-pull circuitry providing the utmost performance available at present. Moreover, the preceding stage that inputs signals to the MOS-FET driver stage forms also a class-A cascode push-pull circuitry. This results in a low distortion output stage that operates stably under any load from the low output signal range (that is affected by noise) to the high output signal range at the rated output.

## 5 Cascode bootstrap differential push-pull configuration dramatically improves characteristics within the NF loop

As the circuit diagram shows, the transistors  $Q_1$  to  $Q_8$  are connected in a cascode bootstrap configuration. The cascode-connection principle provides high gain, and excellent frequency response and phase characteristics are assured, extending into the extreme upper range. An input stage must provide stable operation over a wide range and show no increase in distortion even when the input impedance fluctuates. All of these conditions are perfectly met by the circuit design of the P-300V.

The cascode bootstrap connection is used in a push-pull configuration and in conjunction with the wide-band driver stage. The overall result is dramatically improved performance already within the NF loop, that is even before negative feedback. Another important aspect, the power supply, has been given special attention. A separate winding of the power transformer supplies current for the predriver stage, so that its operation remains unaffected by the condition of the output stage. Separate rectifier and filter circuits for the two channels serve to eliminate interchannel interference.

## 6 Direct-coupled amplifier with DC servo configuration

The signal from the input jacks is supplied directly to the input circuits (INPUT in Fig. 1), without any coupling capacitors in the signal path. If the preamplifier has a large amount of DC drift, this design might lead to the DC voltage being amplified and appearing at the output, which can prove fatal for the speakers. To reliably prevent this possibility, Accuphase uses a proprietary DC servo principle which effectively shuts out DC current. This circuit also contributes to thermal stability and prevents internal DC drift within the amplifier.

## 7 Peak level meters calibrated in dB and watts

The easy-to-read meters permit direct verification of output levels. The meter scale is calibrated in decibels and watts into an 8-ohm load.

## 8 Front-panel input jacks and headphone jack

The P-300V has a total of three inputs (one balanced, two unbalanced), which can be selected by a front-panel switch. One set of unbalanced inputs is located on the front of the amplifier behind a sub panel. This gives easy access, for example for test purposes.

## 9 Two sets of speaker outputs

Two pairs of loudspeakers can be connected to the A and B outputs, which are governed by a front-panel selector. If two sets of speakers are located in the same room and one pair is not used, it may resonate and impair the quality of the reproduced sound. The P-300V is designed to prevent this by automatically short-circuiting the unused speaker pair.

## 10 Persimmon sideboards

In the Accuphase tradition, the front panel of the C-300V is finished in hairline-scratched gold, and the subpanel in hairline-scratched black. The side panels of exquisite persimmon wood further enhance the refined visual appeal for a harmonious blend with your listening room.

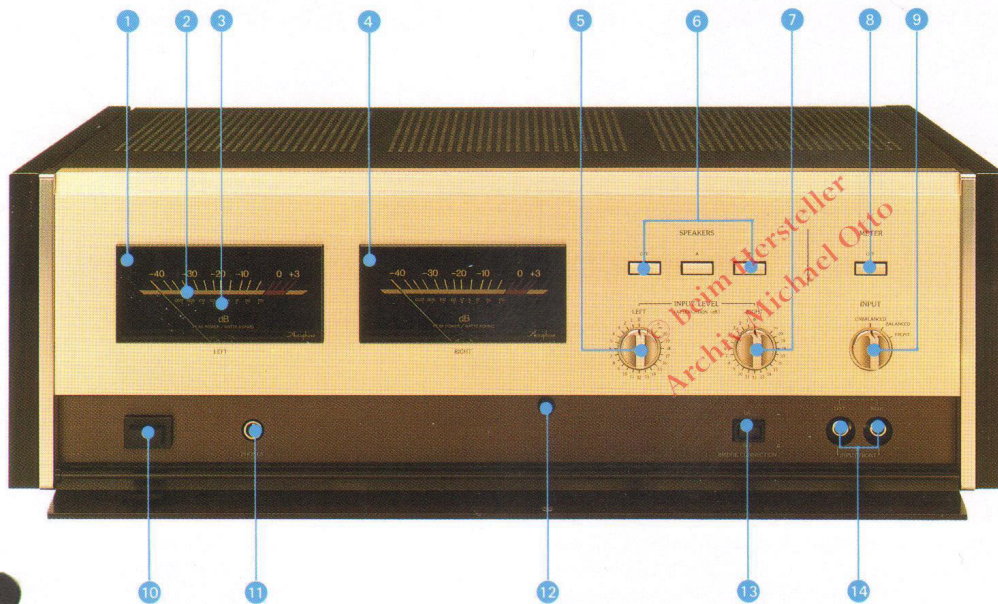

- 1 LEFT-channel power level meter
- 2 dB scale
- 3 Wattage scale for direct reading
- 4 RIGHT-channel power level meter
- 5 LEFT INPUT LEVEL control for bridge connection (monophonic). Adjustable in units of 1 dB
- 6 SPEAKERS selector switches (OFF, A, B)
- 7 RIGHT INPUT LEVEL control. Adjustable in units of 1 dB
- 8 METER ON/OFF switch
- 9 INPUT selector switch (UNBALANCED, BALANCED, FRONT)
- 10 POWER switch
- 11 HeadPHONES jack
- 12 Magnet catch for subpanel
- 13 BRIDGE CONNECTION (monophonic) selector switch
- 14 INPUT FRONT jacks

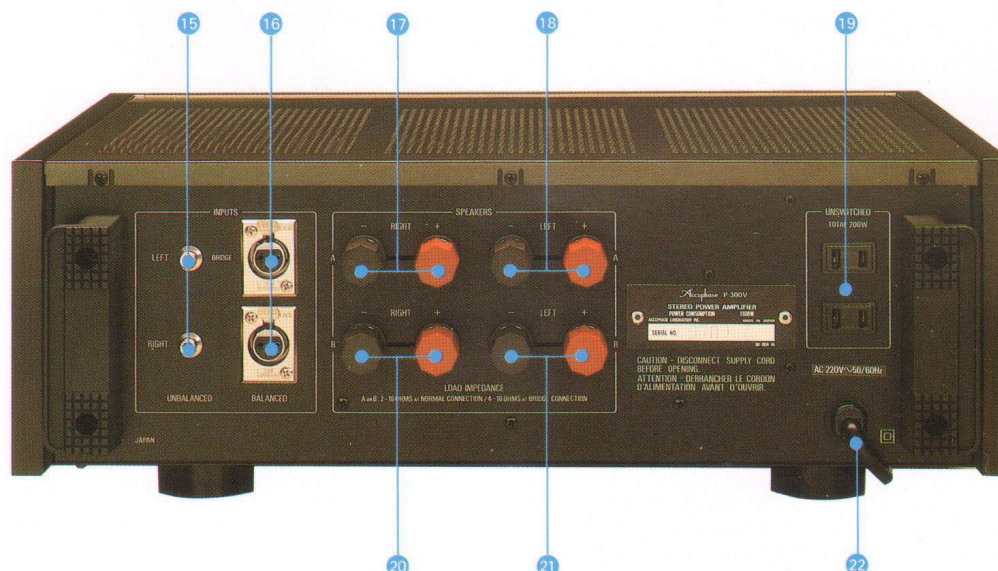

- 15 INPUTS jacks (UNBALANCED, 20k ohms)
- 16 BALANCED INPUTS connectors  
XLR-3-31 or equivalent: ① GND, ② Cold, ③ Hot  
Applicable connector: XLR-3-12C or equivalent
- 17 RIGHT-channel output terminals for speaker A
- 18 LEFT-channel output terminals for speaker A
- 19 AC outlets (UNSWITCHED)
- 20 RIGHT-channel output terminals for speaker B
- 21 LEFT-channel output terminals for speaker B
- 22 AC power cable

# Accuphase P-300V

STEREO POWER AMPLIFIER

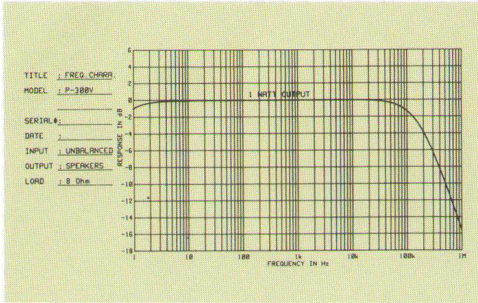

● FREQUENCY CHARACTERISTIC

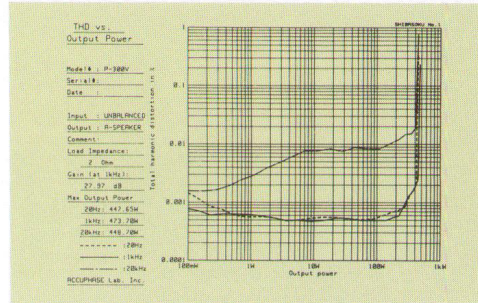

● OUTPUT POWER vs TOTAL HARMONIC DISTORTION CHARACTERISTIC (at 2 ohms load, as stereo amp)

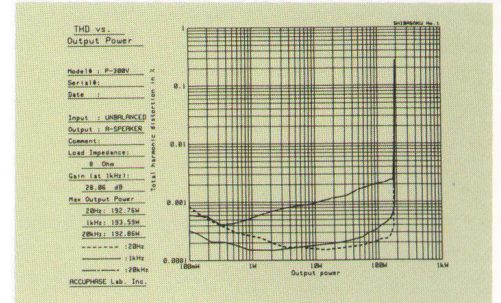

● OUTPUT POWER vs TOTAL HARMONIC DISTORTION CHARACTERISTIC (at 8 ohms load, as stereo amp)

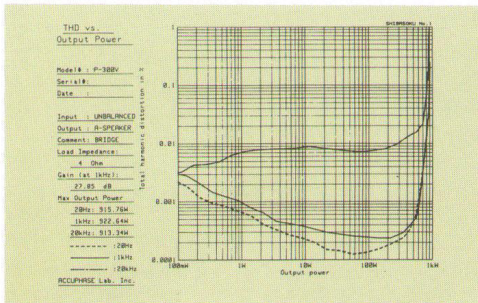

● OUTPUT POWER vs TOTAL HARMONIC DISTORTION CHARACTERISTIC (at 4 ohms load, as monophonic amp)

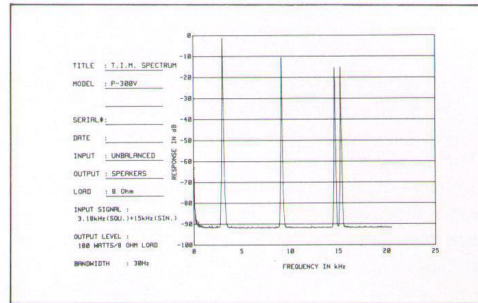

The above graph shows the transient intermodulation distortion (TIM) spectrum. To measure this parameter, a square wave of 3.18 kHz and a sine wave of 15 kHz are mixed and supplied to the input. The square wave signal contains almost infinite odd-number higher harmonics, with components at 9.54 kHz (third harmonic), 15.9 kHz (fifth harmonic), etc. When these components intermodulate with the 15-kHz signal, modulation products show up at frequencies where there is no input signal. For example, if the third harmonic of the 3.18 kHz square wave (9.54 kHz) and the 15 kHz input signal intermodulate, a spectrum can appear at the difference of their frequencies, or at 5.46 kHz (15 kHz - 9.54 kHz). As the graph shows, however, there are no distortion products at all above -93 dB, which means that TIM distortion is less than 0.0022%.

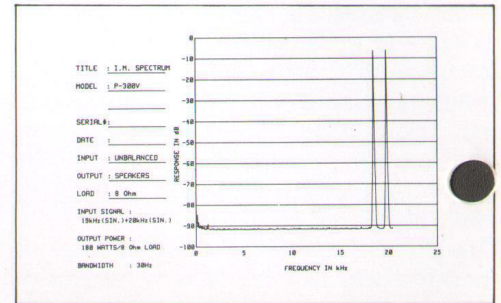

The above graph shows the spectrum of intermodulation distortion characteristic (IHF-IM). Amplitudes of 19 kHz and 20 kHz input signals are shown on the right of the graph. Any intermodulation created by these two signals would appear as spectrum peaks at 1 kHz intervals, the frequency difference between the two signals, across the frequency bandwidth. This data shows them to be hardly noticeable, confirming that IM distortion is less than -93 dB (0.0022%). Another form of IM distortion would appear at 39 kHz, the sum of the two input signal frequencies (19 + 20 = 39 kHz). Such a distortion, even if it existed, would be inconsequential because it is far beyond the audible range. In the P-300V, this form of IM distortion is also less than -93 dB.

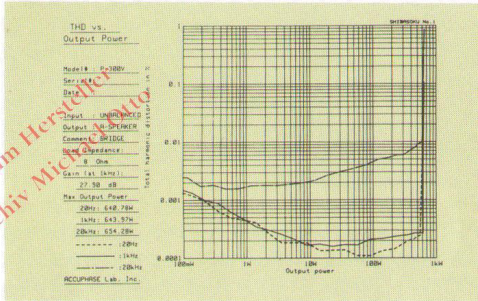

● OUTPUT POWER vs TOTAL HARMONIC DISTORTION CHARACTERISTIC (at 8 ohms load, as monophonic amp)

## GUARANTY SPECIFICATIONS

(Guaranty specifications are measured according to EIA standard RS-490.)

### ● PERFORMANCE GUARANTY

All Accuphase product specifications are guaranteed as stated.

### ● Continuous Average Power Output

From 20 to 20,000 Hz with no more than 0.01% total harmonic distortion.

Stereo mode (Both channels driven)  
350 watts/channel, min. RMS, at 2 ohms  
280 watts/channel, min. RMS, at 4 ohms  
180 watts/channel, min. RMS, at 8 ohms  
90 watts/channel, min. RMS, at 16 ohms

Monophonic mode (Bridged connection)  
700 watts, min. RMS, at 4 ohms  
560 watts, min. RMS, at 8 ohms  
360 watts, min. RMS, at 16 ohms

### ● Total Harmonic Distortion

From 20 to 20,000 Hz at any power output from 1/4 watt to rated power.

Stereo mode (Both channels driven)  
0.01%, at 2 to 16 ohms  
Monophonic mode (Bridged connection)  
0.01%, at 4 to 16 ohms

### ● Intermodulation Distortion

0.003%

### ● Frequency Response

20 to 20,000 Hz: +0, -0.2 dB  
(for rated output, level controls at maximum)  
0.5 to 160,000 Hz: +0, -3 dB  
(for 1 watt output, level controls at maximum or -6 dB)

### ● Gain

28.0 dB (in stereo and monophonic mode)

### ● Output Load impedance

2 to 16 ohms in stereo mode  
4 to 16 ohms in monophonic mode (Bridged connection)

### ● Damping Factor

300 in stereo mode  
150 in monophonic mode (Bridged connection)

### ● Input Sensitivity (with 8 ohm load)

Stereo mode  
1.5 V for rated output  
0.12 V for 1 watt output  
Monophonic mode (Bridged connection)  
2.7 V for rated output  
0.12 V for 1 watt output

### ● Input Impedance

Unbalanced: 20k ohms  
Balanced: 40k ohms

### ● A-weighted Signal-to-Noise Ratio

120 dB with input shorted, at rated output  
100 dB at 1 watt output, terminated with 1k ohms  
(in stereo and monophonic modes)

### ● Headphone Output

Suitable load impedance: 4 to 100 ohms

### ● Output Level Meters

Logarithmic scale, -40 dB to +3 dB range  
Direct watt-reading scale

### ● Semiconductor Complement

90 Tr's 16 FETs 8 IC's 73 diodes

### ● Power Requirements

100 V, 117 V, 220 V, 240 V 50/60 Hz AC

### ● Power Consumption

130 watts at zero signal input  
600 watts at rated power output into 8 ohms

### ● Dimensions

475 mm (18-13/32 inches) width, 170 mm (6-11/16 inches) height (including leg), 408 mm (16-1/16) depth

### ● Weight

24.8 kg (54.6 lb) net, 29.3 kg (64.5 lb) in shipping carton

