

Accuphase

STEREO POWER AMPLIFIER

P-300L

- 5-parallel push-pull circuitry 170W×2 (8 ohms)
- Low impedance speaker can be fully driven
- DC servo controlled throughout
- Built-in bridging connection circuit
- 3P XLR connectors (balanced input) provided

© beim Hersteller
Archiv Michael Otto
FbH-Classic.de



Accuphase P-300L

STEREO POWER AMPLIFIER

The advent of digital recordings (PCM) and compact discs (CD) reveals a growing trend toward digitization of audio equipment, and reproduction of high-fidelity sound that differs from conventional analog recordings is now expected. Parallel to this trend, the reproduction capabilities of conventional analog discs with a history of more than a century have shown a significant amelioration resulting from the improvement of cartridges, record players, amplifiers, and other equipment.

The P-300L adopts the state-of-the-art technologies and the Accuphase circuit design philosophy of "Push-Pull Circuitry in every stage"

Higher-grade power amplifiers must be endowed not only with superior basic characteristics such as frequency characteristics, low distortion ratio, higher signal-to-noise ratio, but with the capability and power to drive speakers correctly with ample energy so that they can respond accurately to instantly changing, wide-ranging signal variations. This necessitates a power supply with an ample reserve margin to provide the full energy that is required by a powerful output circuit driven by a large current capacity driver stage.

As a result of emphasis on the improvement of sound quality, the P-300L incorporates a power supply comprising a large-sized toroidal transformer and two capacitors each of which with a capacitance of 47,000 μF . Moreover, the P-300L is provided with a powerful output stage with a low impedance. This output stage consists of five parallel push-pull circuits each comprising 2 output transistors. The maximum power dissipation (P_c) of each of the 10 transistors is 100 watts. The P-300L can be thus driven at a low impedance providing an outstanding output. For example, the output is 170 watts per channel (20–20,000 Hz, total harmonic distortion of not more than 0.01%) when connected to an 8-ohm load and 300 watts per channel when connected to a 2-ohm load. The P-300L can therefore supply a stable energy to such speakers whose impedance greatly fluctuates and thereby can substantially improve the linearity of audio signals. Now, the dynamism of music can be perfectly reproduced.

Each of the driver stages supplying signals to the output stage constitutes a cascode push-pull circuit realizing a sufficiently wide band and low harmonic distortion within the

loop. The high-quality and stable drive that the P-300L features is thus realized.

The P-300L is provided with 600-ohm Balanced type Input Connectors that exactly matches the 600-ohm balanced type output lines of Accuphase Stereo Preamplifiers C-280 and C-200L. Degradation of sound quality due to noises picked up by the signal cables between the preamplifier and the power amplifier is therefore eliminated.

Moreover, since the P-300L incorporates a bridging connection, the output of the P-300L can be increased to 500 watts (when connected to an 8-ohm load) to serve as a monophonic amplifier thus upgrading the output and satisfying the demands for a wide dynamic range that is essential in the present era.

To obtain a high-quality reproduction, good quality of low-level signals is vital. The P-300L is provided with Class-A driver stages, MOS FET driver circuitry, and output circuitry free from crossover distortion to maintain excellent sound quality of low listening level.

The P-300L can be combined with not only the C-200L Stereo Control Center but also any model of Accuphase preamplifiers.

1 OUTPUT STAGE CONSISTING OF 5-PARALLEL PUSH-PULL CIRCUITRY GUARANTEES 300W/ch AT 2-OHM LOAD, 170 W/ch AT 8-OHM LOAD

Fig. 1 shows the amplifier circuit diagram which is the heart of the P-300L. The output stage is composed of 5-parallel push-pull circuitry that includes 10 transistors (Q_{17} through Q_{26}). Each transistor has maximum power dissipation (P_c) of 100 watts, resulting in a total capacitance of 1 kW. The transistors are mounted to a large-sized aluminum heat sink that adequately dissipate the heat generated so that an output of 170 watts per channel (20–20,000 Hz; total harmonic distortion of no more than 0.01%) is obtained at 8-ohm load.

The impedance of speakers vary greatly according to the input signal frequencies. The impedance of some speakers decreases to half or less of the nominal value. To supply power with proper linearity to such speakers, the speakers must be driven by a power amplifier capable of supplying a sufficient output at low load impedance. The P-300L is able to transmit the exact replica of the input signals to speakers at as low a load impedance as 2 ohms thanks to the high-power output stage and powerful power supply. The P-300L provides the rated output of 300 watts per channel at 2-ohm load.

Distortion of low-level signals at the output stage seriously degrades sound quality. The distortion occurs especially when the crossover

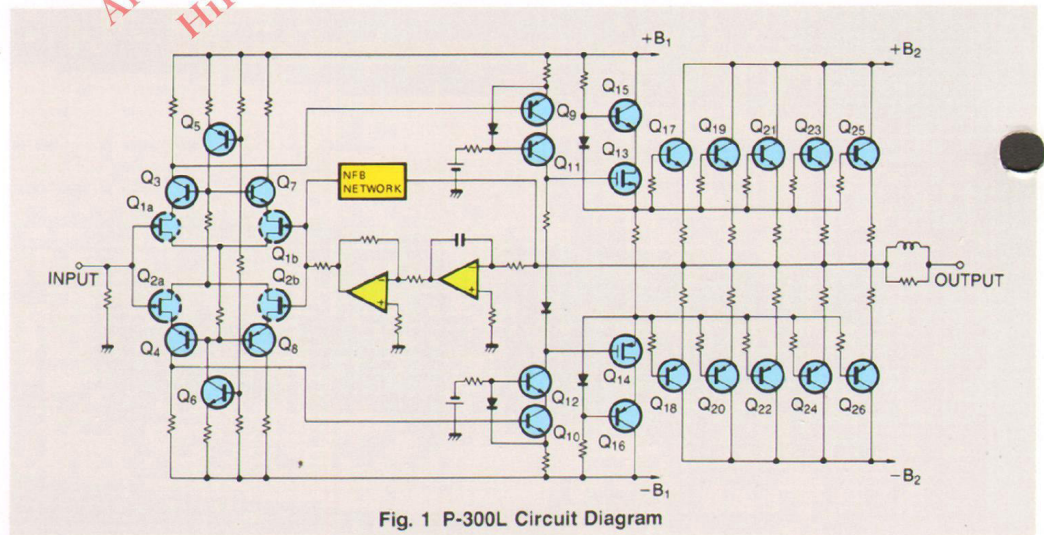

Fig. 1 P-300L Circuit Diagram

point of the operations of the push-pull circuits, each comprising a PNP transistor and an NPN transistor, are not performed successively, or when one of the paired transistors is in the cutoff state. To prevent such distortion, the P-300L is designed for no crossover distortion, which provides a prominently elegant sound of low-level signals despite the fact that the P-300L is designed to produce a high output.

2 CASCODE PUSH-PULL AND MOS FET CASCODE PUSH-PULL CIRCUITRY DRIVER STAGE REALIZES EXCELLENT LINEARITY, HIGH-FREQUENCY CHARACTERISTICS, AND LOW HARMONIC DISTORTION OF LOW-LEVEL SIGNAL

Unlike amplifiers for large auditoriums, amplifiers for noncommercial purposes are used in a situation where the distance between the listener and speakers is short. Therefore, sound

All-stage push-pull circuitry. 5-parallel push-pull power monophonic=500 W (8 ohms). Even an extremely low a powerful output stage specially designed for this p

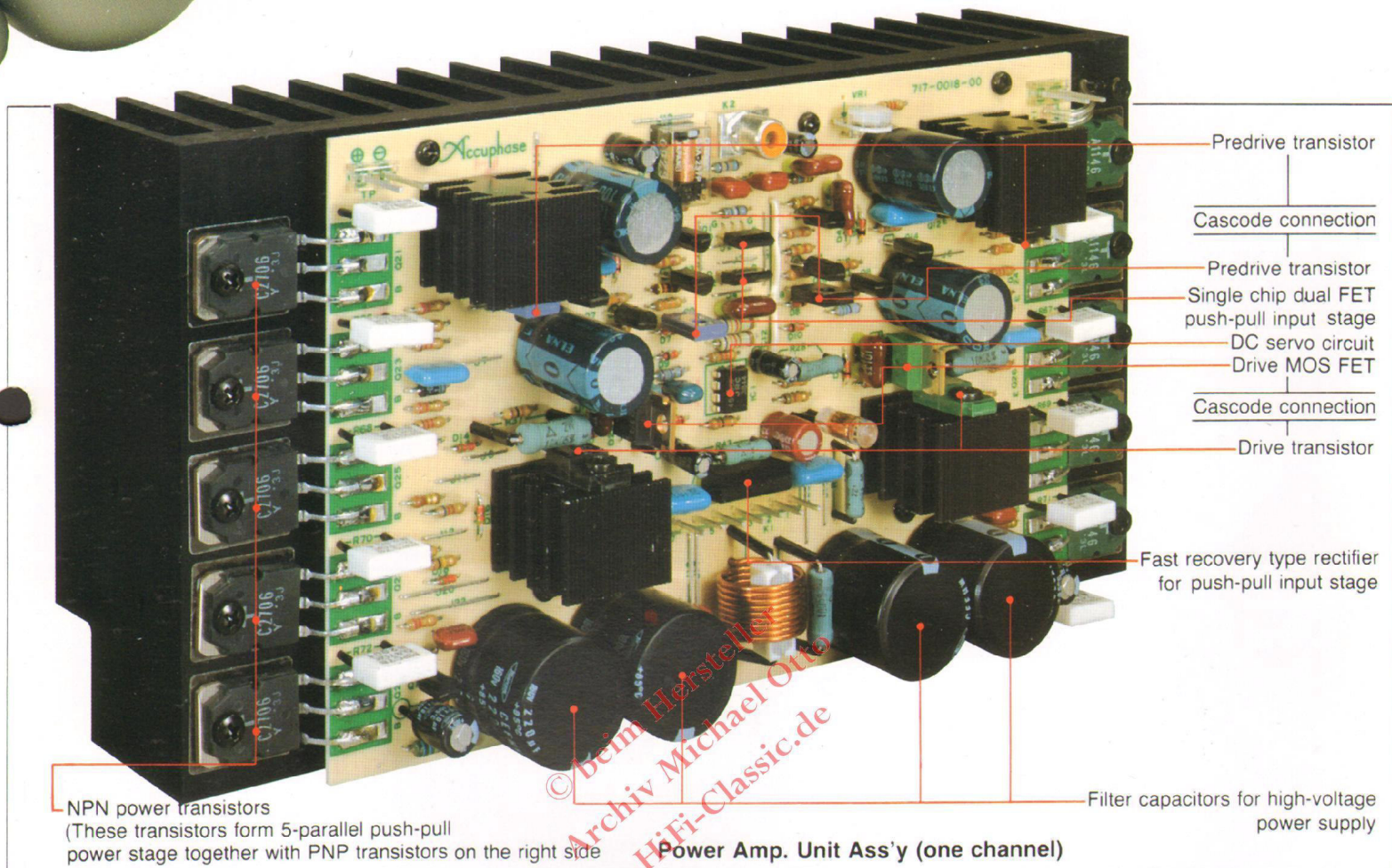

quality of low listening level, below 5 watts is as important a factor of such amplifiers as the signal-to-noise ratio. The same as many other Accuphase power amplifiers, P-300L is designed with special emphasis on the characteristics of low listening level.

As mentioned above, problems concerning the output stage are solved by means of the non-crossover distortion design. However, the design of the preceding stage that drives the output stage becomes a key point for a power amplifier, because it requires a large amplitude and a large current. The driver stage of the P-300L uses MOS FETs, whose excellence has been proven in a number of Accuphase power amplifiers so far developed and introduced to the market. Also this driver stage is made up of cascode push-pull circuits providing upper-limit high-frequency characteristics. Furthermore, the predriver stage which inputs signals to the MOS-FET driver stage is provided with Class-A cascode push-pull circuitry and thereby dramatically improve the basic characteristics.

3 CASCODE BOOTSTRAP PUSH-PULL DIFFERENTIAL AMPLIFIER INPUT STAGE

A cascode bootstrap circuit satisfies all the requirements of an input circuit: high gain excellent high-frequency characteristics, and no deterioration of harmonic distortion even when the input impedance varies. For perfect

tion of the high performance of a cascode bootstrap circuit, that of the P-300L includes a push-pull circuit. Transistors Q_1 through Q_8 in Fig. 1 constitute a cascode bootstrap push-pull circuit. Together with the wide-band driver stage, the basic characteristics within the negative feedback loop is radically improved.

4 DIRECT COUPLED AMPLIFIER EMPLOYING DC SERVO CONTROL CIRCUITRY

The input signals to the P-300L is directly coupled to the INPUT terminal shown in Fig. 1. Therefore, when a preamplifier with a large DC (direct current) drift is connected, the DC components in the input signal is amplified and contained in the output signal. This possibly results in damage to the speakers. The P-300L has a DC Servo Control circuit, an original by Accuphase, to block such DC components and at the same time to stabilize the DC drift of the amplifier caused by temperature fluctuation.

5 600-OHM BALANCED TYPE INPUT CONNECTOR DOES NOT PICK UP INDUCTIVE NOISE EVEN WHEN CABLE EXTENDED

The use of a 600-ohm balanced type cable network has long been a standard practice of broadcasting stations and commercial applications where lengthy cable connections are necessitated, but noise pickup must be pre-

vented. Besides the conventional unbalanced input connector (phono jack) of 20k ohms, this power amplifier is provided with a genuine 600-ohm Balanced Input Connector (3P XLR type).

Its operating principle is shown in Fig. 2. A positive and a negative signal with voltages identical to the ground potential are transmitted by the balanced cable network. Even if unwanted noise disturbances happen to be picked up by the cable, the positive and negative noise signals will appear in the same phase at the input of the differential amplifier where they are cancelled out. This prevents lengthy interconnecting cables from deteriorating sound quality. Since the Accuphase C-280 and C-200L Preamplifier also has an output connector for 600-ohm balanced type connecting cables, the two components can be used very effectively for lengthy interconnections. Phase reversal to cancel out noise pickup is, of course, accomplished in this power amplifier, with a low distortion, wideband differential amplifier circuit instead of a simple transformer.



...er stage guarantees stereo=170 W/ch (8 ohms),
 ...v impedance load of 2 ohms can be fully driven by
 ...urpose.

6 BRIDGING CONNECTION PERMITS PURE MONOPHONIC OPERATION WITH 500 WATTS AT 8 OHMS AND 600 WATTS AT 4 OHMS

If each power amplifier of the P-300L is taken as a single device and used together respectively with a bridge connection as a push-pull monophonic driver, a very large monophonic power output can be obtained. This connection is called bridge connection or BTL connection.

Fig. 3 shows the principle in which an identical waveform is fed to the respective left and right channels in counterphase. Connecting the speakers then to the output of both amplifiers will double the signal input voltage to the speakers which will theoretically quadruple the power of the single amplifier. In actual use, however, the output of amplifiers is affected by loss in the circuit and limitations of the output transistors' current capacity. Therefore, the double of the output at 4-ohm load using only one amplifier will be actually equal to the output at 8-ohm load with bridging connection.

Another advantage of push-pull operation is improved characteristics due to the elimination of harmonic distortion as even-number harmonics are cancelled out. Bridging the two channels provides a monophonic power output of 500 Watts at 8 ohms and 600 Watts at 4 ohms, enabling good music reproduction with an opulent sound. Because the amplifier gain when bridging two channels is the same as that in a separate amplifier system, accurate input level can be easily adjusted for multiple amplification systems as well.

7 LOGARITHMIC SCALED PEAK LEVEL METER WITH PEAK HOLD FEATURE

A convenient Peak Level Monitoring Meter is available. It is logarithmically scaled and indicates continuous direct readings of maximum output, both in terms of dB and watts into 8-ohm impedance loads. It can be switched to indicate and hold the maximum power reading position reached in every three-second sampling period.

8 INPUT/OUTPUT TERMINALS HIDDEN UNDER THE SUBPANEL

The P-300L allows switch selection of three pairs of outputs and three pairs of inputs. One pair each of the above connectors is hidden under the front subpanel, which makes it very convenient for testing audio equipment.

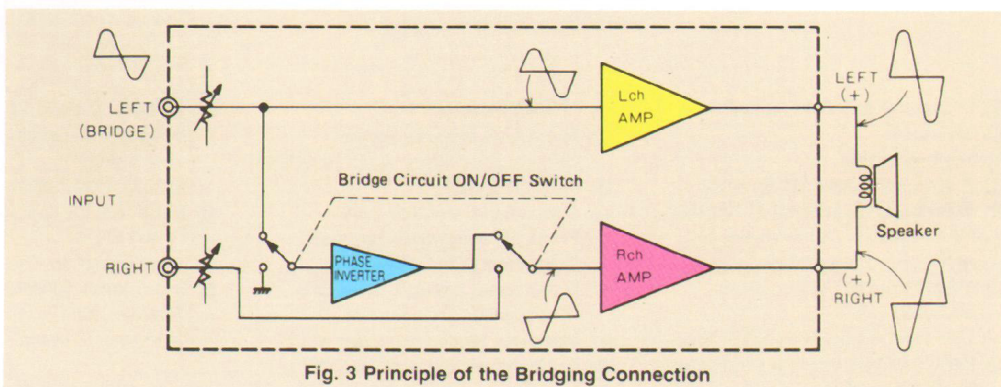
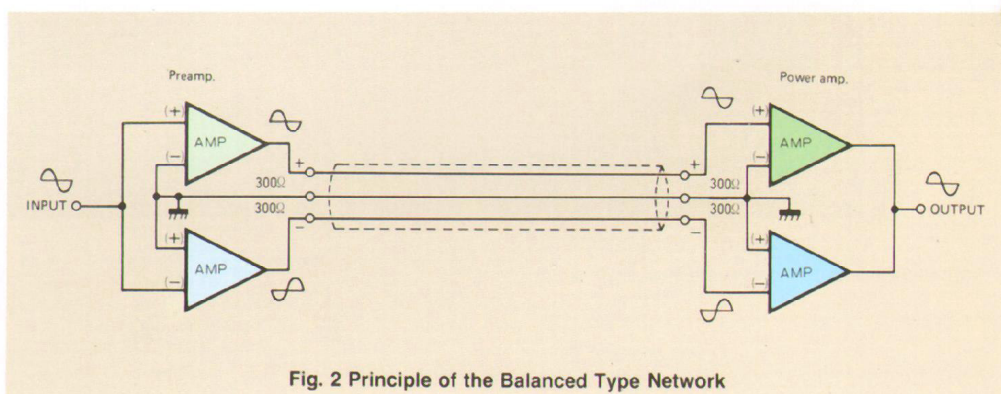
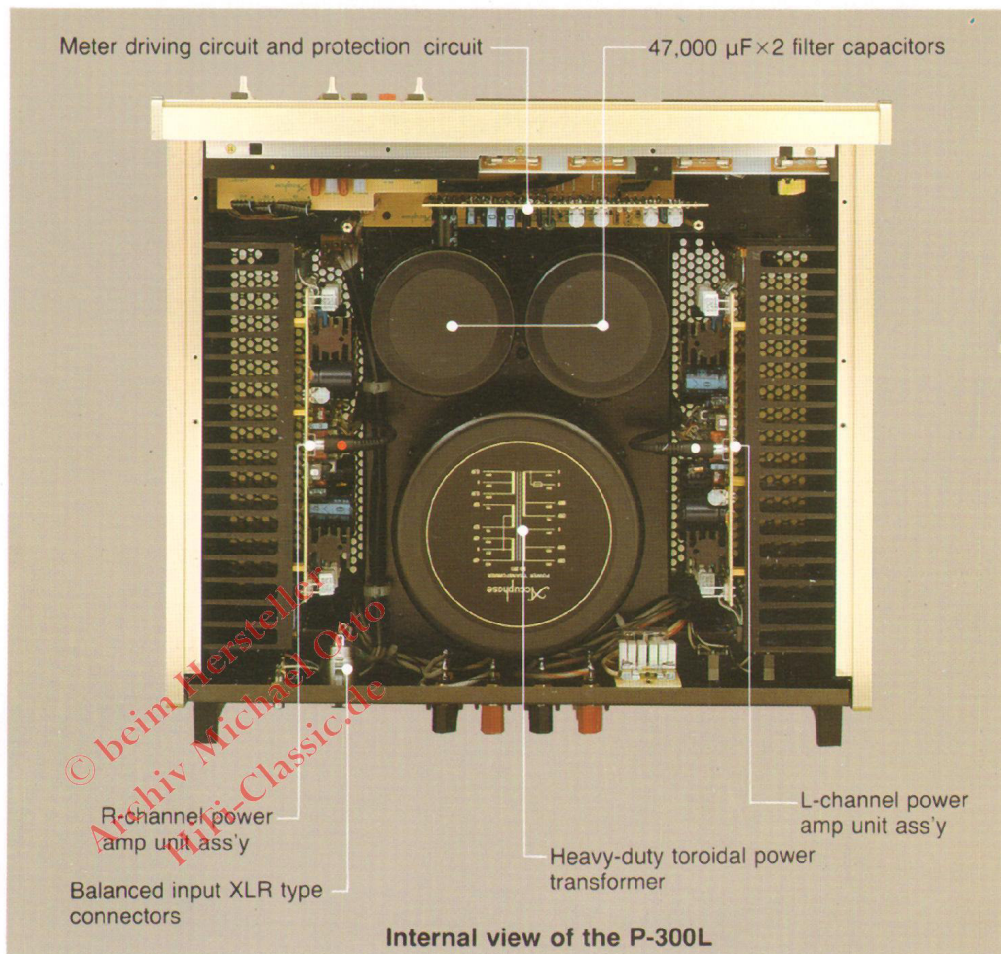

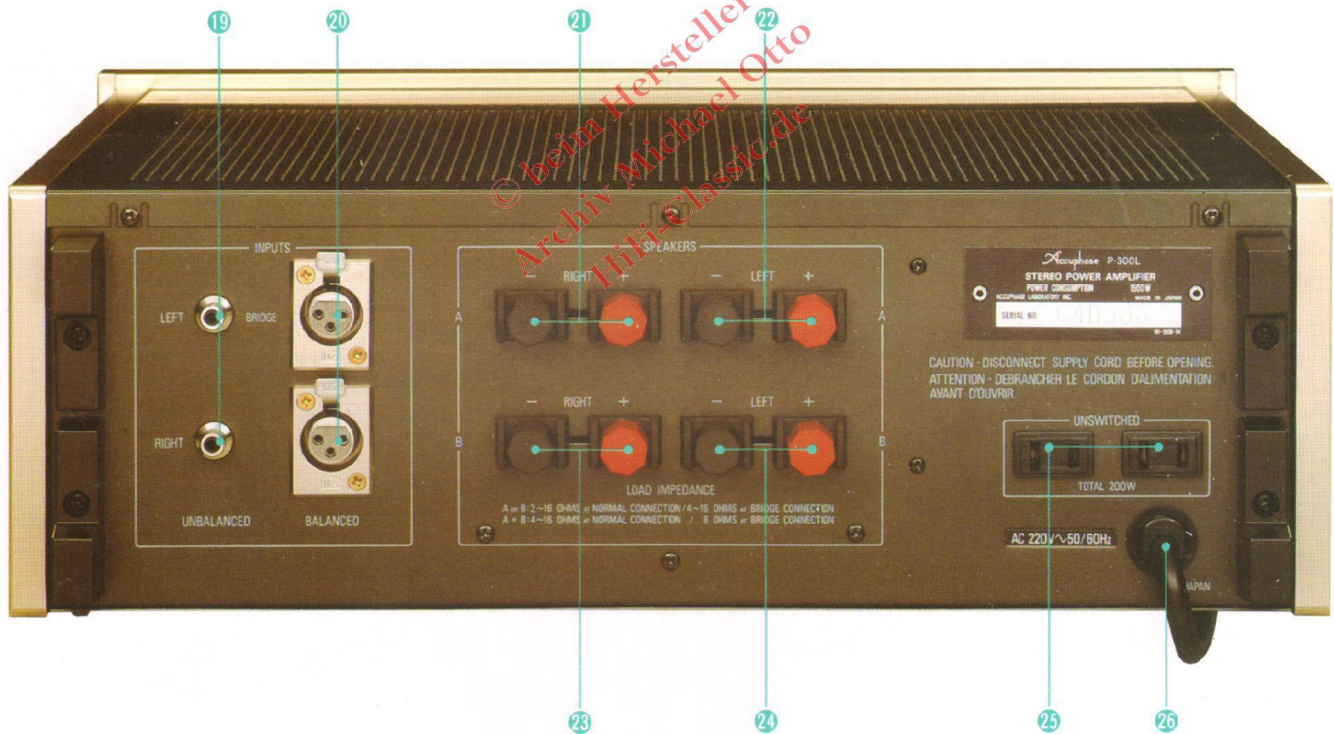
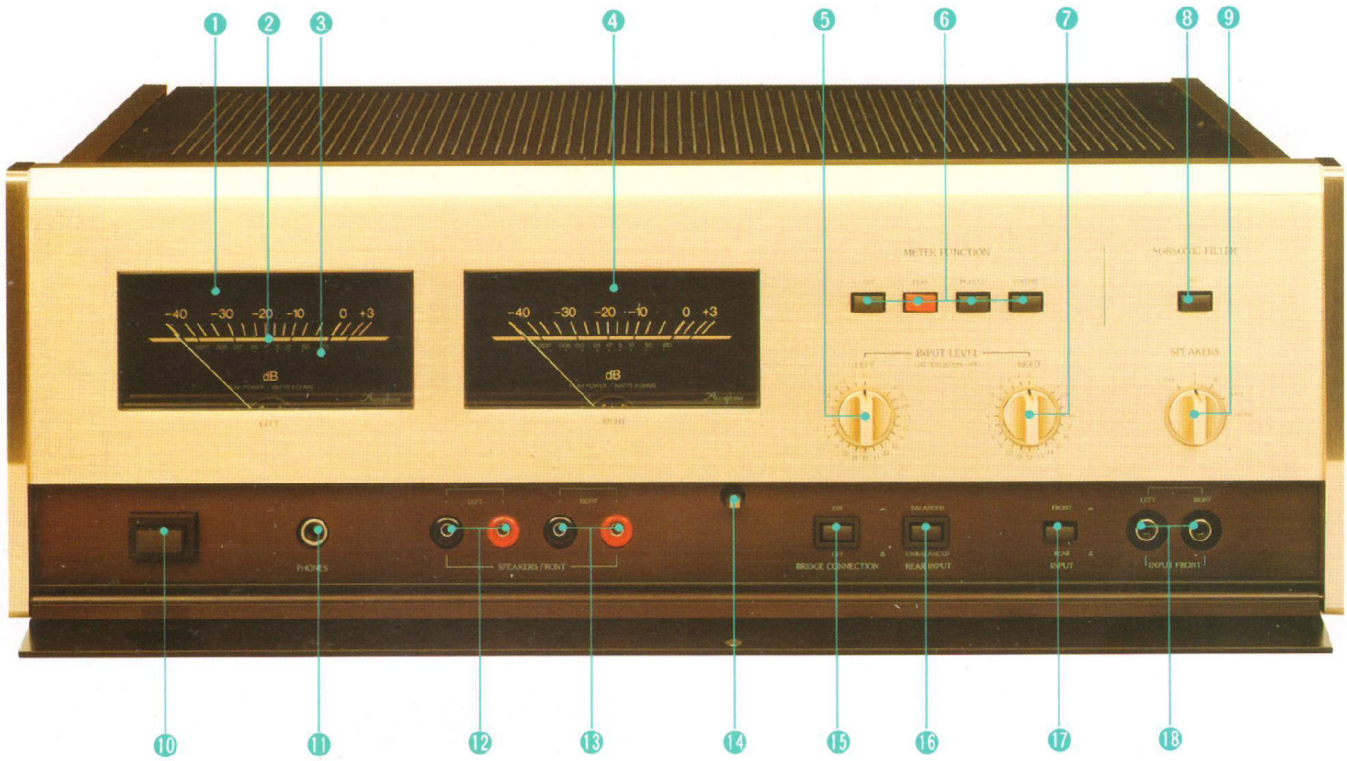

- 1 L-channel power level meter
- 2 dB scale
- 3 Wattage scale
- 4 R-channel power level meter
- 5 INPUT LEVEL control (1 dB step) for L-channel and bridged monophonic operation
- 6 METER FUNCTION selector switches
OFF PEAK PK.HOLD VOLUME
- 7 INPUT LEVEL control (1 dB step) for R-channel

- 8 SUBSONIC filter
- 9 SPEAKER selector switch
OFF A B A+B FRONT
- 10 POWER switch
- 11 Stereo head PHONE jack
- 12 Front panel speaker terminals (L-channel)
- 13 Front panel speaker terminals (R-channel)
- 14 Magnetic catch for subpanel
- 15 Bridging connection ON/OFF switch

- 16 Selector switch for balanced/unbalanced input selection
UNBALANCED/BALANCED
- 17 Input selector switch
REAR/FRONT
- 18 Input jacks on the front panel
Use the LEFT jack for bridged monophonic operation.

- 20 3P XLR type input jacks (BALANCED/600Ω)
Use the LEFT connector for bridged monophonic operation.
- 21 Speaker A R-channel output
- 22 Speaker A L-channel output
- 23 Speaker B R-channel output
- 24 Speaker B L-channel output
- 25 AC outlet (UNSWITCHED)
- 26 AC power cord

Accuphase P-300L

STEREO POWER AMPLIFIER

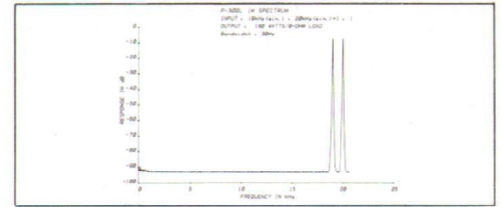
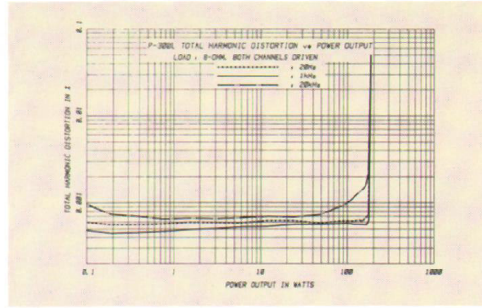
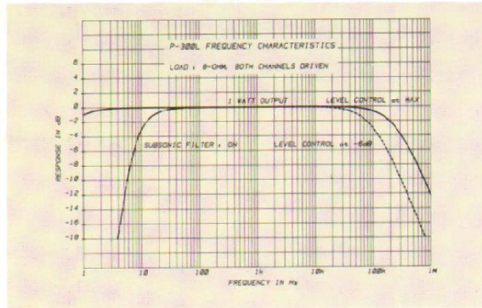

The above data shows the spectrums of intermodulation distortion for the P-300L as measured by the new IHF measurement method. Amplitudes of a 19kHz and 20kHz input signals are shown at the right side. Any intermodulation created by these two signals would appear as spectrum peaks at 1kHz intervals, the frequency difference between the two signals, across the frequency bandwidth. This data shows them to be hardly noticeable, confirming that IM distortion is less than -93 dB (0.0022%).

Another form of IM distortion would appear at 39kHz, the sum of the two input signal frequencies (19+20=39kHz). Such a distortion, even if it existed, would be inconsequential because it is far beyond the audible range. In the P-300L, this form of IM distortion is also less than -93dB.

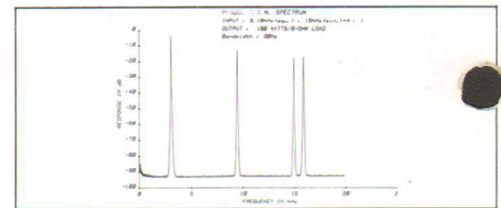
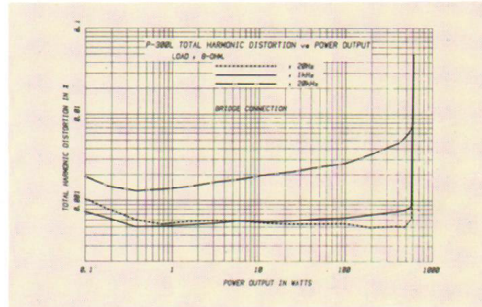
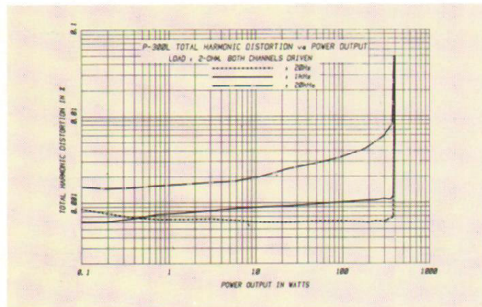

The above data shows the spectrum characteristics of transient intermodulation distortion for the P-300L when two mixed input signals, a 3.18kHz square wave and a 15kHz sine wave, are used. Since harmonics of square waves appear almost infinitely at odd-number multiples, for example in this case at 9.54kHz (3rd harmonic) 15.9kHz (5th harmonic) they can create, together with the 15kHz input sine wave, intermodulated spectrums at frequencies where input signals are absent. For example, if the third harmonic of the 3.18kHz square wave (9.54kHz) and the 15kHz input signal intermodulate, a spectrum can appear at the difference of their frequencies or 5.46kHz (15-9.54=5.46kHz). However, the above data shows no spectrum above -93dB at that frequency which confirms that TIM distortion is less than 0.0022%.

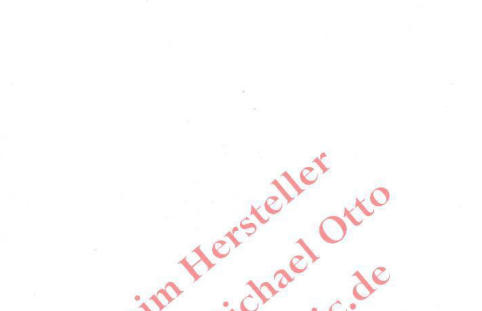
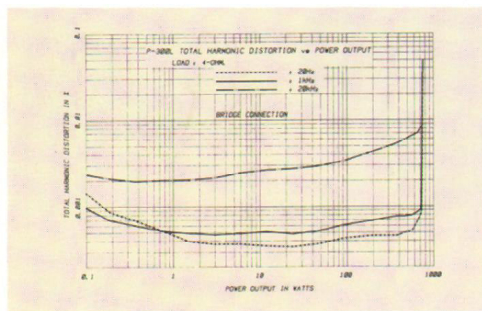

P-300L GUARANTY SPECIFICATIONS

● PERFORMANCE GUARANTY:

All Accuphase product specifications are guaranteed as stated.

● CONTINUOUS AVERAGE POWER OUTPUT (EIA):

STEREOPHONIC MODE:

Both channels driven, from 20 Hz to 20,000 Hz with no more than 0.01% total harmonic distortion:
 300 watts per channel, min. RMS, at 2 ohms
 250 watts per channel, min. RMS, at 4 ohms
 170 watts per channel, min. RMS, at 8 ohms
 85 watts per channel, min. RMS, at 16 ohms

MONOPHONIC MODE (Bridging Connection):

From 20 Hz to 20,000 Hz with no more than 0.01% total harmonic distortion:
 600 watts, min. RMS, at 4 ohms
 500 watts, min. RMS, at 8 ohms
 340 watts, min. RMS, at 16 ohms

● TOTAL HARMONIC DISTORTION:

STEREOPHONIC MODE:

Both channels driven, from 20 Hz to 20,000 Hz at any power output from 1/4 watt to rated power:
 0.01% max., at 2 ohms to 16 ohms

MONOPHONIC MODE (Bridging Connection):

From 20 Hz to 20,000 Hz at any power output from 1/4 watt to rated power:
 0.01% max., at 4 ohms to 16 ohms

● INTERMODULATION DISTORTION (EIA):

Will not exceed 0.003% at rated power output.

● FREQUENCY RESPONSE (EIA):

20 Hz to 20,000 Hz: ± 0.2 dB for rated output at the maximum level control
 0.5 Hz to 250,000 Hz: ± 0.3 dB for 1 watt output at the maximum level control
 0.5 Hz to 100,000 Hz: ± 0.3 dB for 1 watt output at -6 dB attenuation

● VOLTAGE AMPLIFICATION IN DECIBELS:

28.0 dB in STEREOPHONIC and MONOPHONIC MODES (Bridging Connection)

● OUTPUT LOAD IMPEDANCE:

2 ohms to 16 ohms in STEREOPHONIC MODE
 4 ohms to 16 ohms in MONOPHONIC MODE (Bridging Connection)

● DAMPING FACTOR (EIA, at 50 Hz):

300 in STEREOPHONIC MODE
 150 in MONOPHONIC MODE (Bridging Connection)

● INPUT SENSITIVITY (at 8 ohms load):

STEREOPHONIC MODE:
 1.5 V, for rated output at the maximum level control
 0.12 V, for 1 watt output (EIA)
 MONOPHONIC MODE (Bridging Connection):
 2.5 V, for rated output at the maximum level control
 0.12 V, for 1 watt output (EIA)

● INPUT IMPEDANCE:

20k ohms UNBALANCED Input and 600 ohms BALANCED Input selectable by INPUT selector on the front subpanel

● A-WEIGHTED SIGNAL-TO-NOISE RATIO:

STEREOPHONIC AND MONOPHONIC MODES:
 120 dB below rated output, inputs shorted
 100 dB at 1 watt output, terminated with 1k ohm (EIA)

● HEADPHONE JACK:

For listening with low impedance (4-100 ohms) dynamic stereo headphones

● SUBSONIC FILTER: 10 Hz cutoff, -18dB/oct.

● POWER LEVEL METER:

Logarithmic Scale Peak Level indication of the dynamic range from -40 dB to +3 dB with Peak-Hold circuit, calibrated to read 0dB at 170 watts into 8 ohms load.

● SEMICONDUCTOR COMPLEMENT:

56 Tr's, 12 FETs, 8 ICs and 78 Di's

● POWER REQUIREMENT:

Voltage selection by rewiring for 100V, 117V, 220V and 240V, 50/60 Hz operation

● POWER CONSUMPTION (STEREOPHONIC MODE):

78 watts at zero signal output
 560 watts at rated power output into 8 ohms load

● DIMENSIONS:

width 445 mm (17-1/2 inches), max. height 160 mm (6-5/16 inches), depth 373 mm (14-11/16 inches)

● WEIGHT:

23 kg (50.6 lb) net, 27.5 kg (60.5 lb) in shipping carton

Accuphase
 ACCUPHASE LABORATORY INC.