

# Accuphase

## MONOPHONIC POWER AMPLIFIER

# M-1000

- Ultra-powerful output stage delivers 1,000 watts into 8 ohms
- Outstanding low-impedance drive capability
- Digital power meter shows true power levels
- Balanced input

eller  
ael Otto

© beim Hersteller  
Archiv Michael Otto



## Two power units, each containing 14 parallel push-pull transistor pairs When switched to low-impedance drive, guaranteed output power is

The M-1000 is a monophonic power amplifier that delivers power levels only available before in professional equipment. Its performance perfectly matches the requirements of a new age of high-quality audio. It represents another pinnacle of Accuphase engineering.

Naturally, in a normal listening room, even when driving low-impedance speakers to high levels, 1,000 watts of output power are not absolutely mandatory. But the difference between having just enough power to get by and having an ample performance margin with room to spare is clearly evident to discerning ears in demanding music reproduction. It may be compared to the superior driving comfort one experiences in a high-powered limousine.

Of course, the single most important requirement of a power amplifier designed for music enjoyment in the home is sound quality. Merely providing high power is not enough. Musical detail, imaging, depth, ambience all must be reproduced to the finest nuance. The M-1000 was designed to unite high power and sonic excellence. It uses two power units in bridged configuration, forming a totally balanced amplifier. Meticulous attention has been paid to every detail, and original Accuphase technology is used throughout, with the aim to improve quality especially at low signal levels.

The impedance of loudspeakers on the market varies considerably, ranging from about 2 ohms to 16 ohms. With a direct-coupled amplifier, driving such a wide impedance range with equal aplomb is almost impossible. An output stage designed for optimum performance at 2 ohms will deliver less power into 8 to 16 ohms. Conversely, the performance of an amplifier optimized for about 4 to 8 ohms suffers at 2 ohms and it will not be capable of driving 1-ohm loads. The M-1000 incorporates a special design to deal with a wide range of load impedances. The applied voltage of its output devices can be switched to a lower value, to provide the high current capability required by low-impedance

loads. This results in a truly amazing guaranteed rating of 1,600 watts into 1 ohm and 1,100 watts into 2 ohms, with undiminished sound quality. To achieve such stunning performance, the output stage of each power unit employs 14 parallel push-pull pairs of wide-band transistors with a maximum power dissipation ( $P_c$ ) of 150 watts each. This amounts to 28 devices per unit (56 devices in total with a combined maximum power dissipation of 8,400 watts). These truly astounding figures testify to the no-holds-barred design approach of the M-1000.

To let you monitor its performance, the M-1000 incorporates a newly developed digital power meter as well as an analog output level meter. As opposed to conventional indicators, the revolutionary design of the digital meter detects the actual signal voltage and current levels supplied to the speaker and displays actual output power in real time.

The beautiful and simple elegance of this amplifier's external appearance belies its awesome performance. But when turned on, it speaks unmistakably through music.

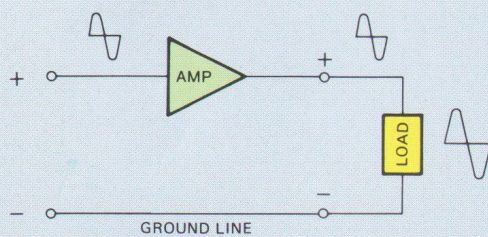
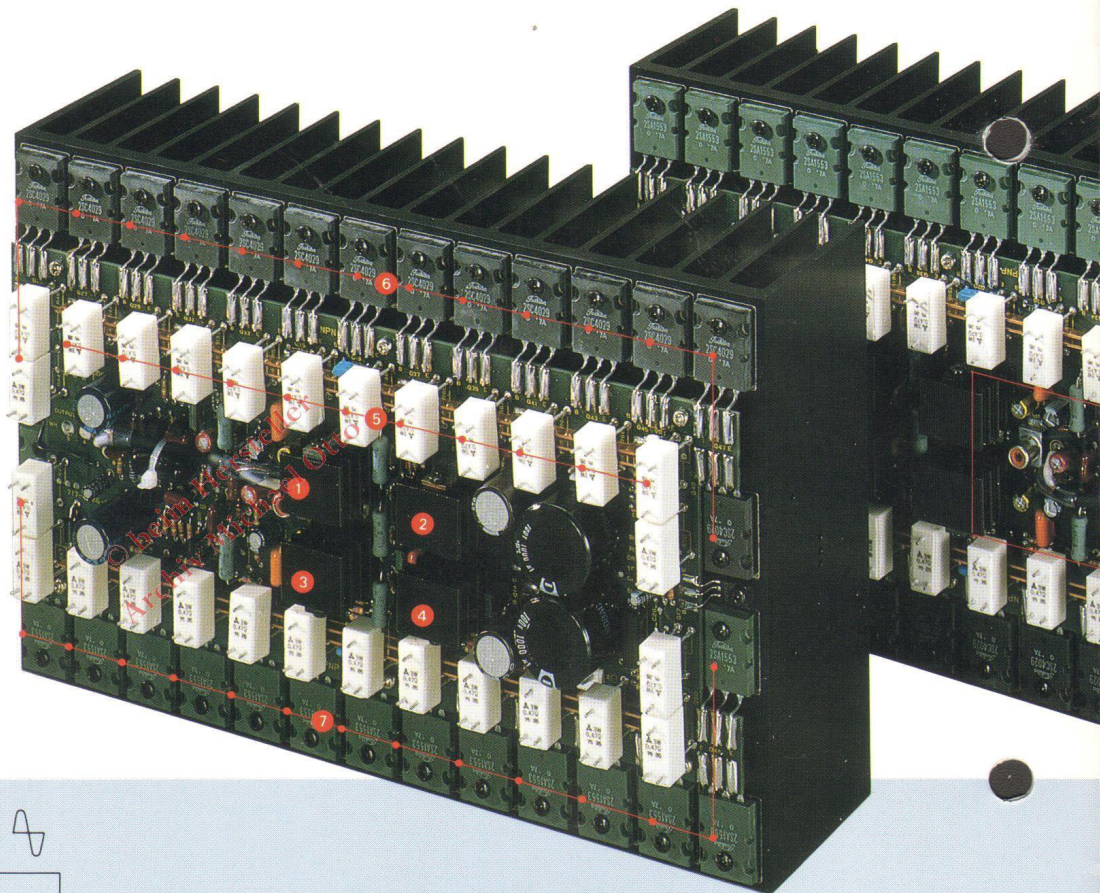

(a) Imbalanced Transfer

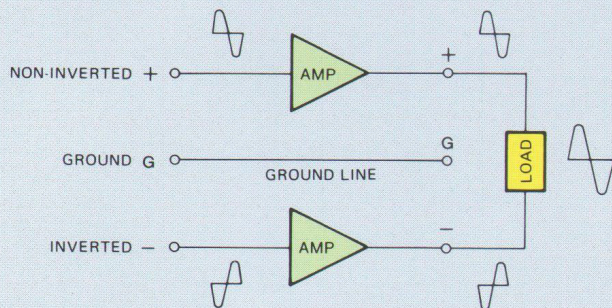

(b) Balanced Transfer

- 1 Class A cascode NPN transistor predriver
- 2 N-ch power MOS FET driver
- 3 Class A cascode PNP transistor predriver
- 4 P-ch power MOS FET driver
- 5 Emitter follower resistors
- 6 15 NPN output transistors including power transistor drivers
- 7 15 PNP output transistors including power transistor drivers
- 8 Class A cascode differential push-pull input stage

Perfectly balanced amp  
bridge-connected power

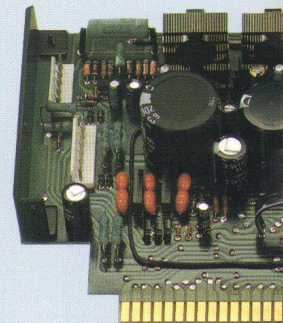

Output relay control ICs and  
supply regulator PCBs.

Fig. 1 Two Signal Transfer Methods

rs, are connected in a balanced configuration to produce 1,000 watts into 8 ohms, and 1,800 watts into 4 ohms, and an amazing 1,100 watts into 2 ohms and 1,600 watts into 1 ohm. True power levels are indicated in real t

### 1 **Totally balanced construction with two separate power units for ultimate sound quality**

The two basic principles shown in Fig. 1 are available to transmit signals in an audio system: (a) unbalanced, and (b) balanced lines. The widely used unbalanced principle permits simpler circuit design, as can be seen from the chart, but this approach involves the possibility of sound quality degradation, because the ground line carries the signal current, DC components to drive the amplifier, and often induced noise from external interference sources. The more elaborate balanced approach requires two separate lines which carry the non-inverted signal and inverted signal. An inherent advantage of this principle is the cancelation not only of noise induced during the transmission process but even of distortion components arising within the amplifier. This cancelation takes place in the output circuits, and the overall effect is a signal of pure and undiluted quality. The Accuphase M-1000 uses two separate power amplifier units with push-pull drive in bridged connection, for the ultimate in performance and sound quality.

power dissipation amounts to an astounding 8.4 kilowatts. Of course, Accuphase never sacrifices quality for quantity. Topnotch design and construction throughout ensure that this awe-inspiring power is delivered with impeccable fidelity. Large heat sinks made of solid aluminum permit operation under normal conditions without cooling fans.

### 3 **Excellent low-impedance drive capability - 1,600 watts into 1 ohm, 1,100 watts into 2 ohms**

As the operating conditions of an amplifier vary considerably depending on load impedance, it is not possible to achieve high current capability for speaker loads ranging from 1 to 16 ohms with exactly the same amplifier configuration. To effectively supply power to speakers with an impedance of 4 ohms and above, the drive voltage of the output stage must be high. However, if a load of 1 or 2 ohms is connected to such an output stage and high current is supplied, the area of safety operation of the output transistors will be exceeded and the devices may be destroyed. To achieve optimum power for low-impedance loads, the applied voltage of the output transistors should be low, while output current capability must be increased.

The M-1000 perfectly fulfills both of these requirements. It can comfortably drive both low and high impedance loads, due to a switching arrangement which matches the applied voltage of the output stage to the respective load condition. This "Low Load Impedance" switch makes it possible to supply a full 1,600 watts into 1 ohm and 1,100 watts into 2 ohms. Thanks to this design, which is also incorporated in the Accuphase amplifier P-600, the M-1000 is fully capable of driving "difficult" flat diaphragm speakers or electrostatic speakers with low efficiency and low impedance ratings.

### 2 **Ultra-powerful output stage consisting of two units with 14 parallel push-pull transistor pairs each.**

Fig. 2 shows the output stage of the M-1000. Two exactly identical amplifier units are used in bridged configuration. The input signal is connected to these units with inverted phase, resulting in a combined output power rating of 1,800 watts into 4 ohms and 1,000 watts into 8 ohms (guaranty specifications). This impressive power is achieved by an extravagant design involving 14 pairs of parallel push-pull devices in each amplifier unit. Each transistor has a maximum power dissipation of 150 watts. As there are a total of 56 devices, the combined maximum

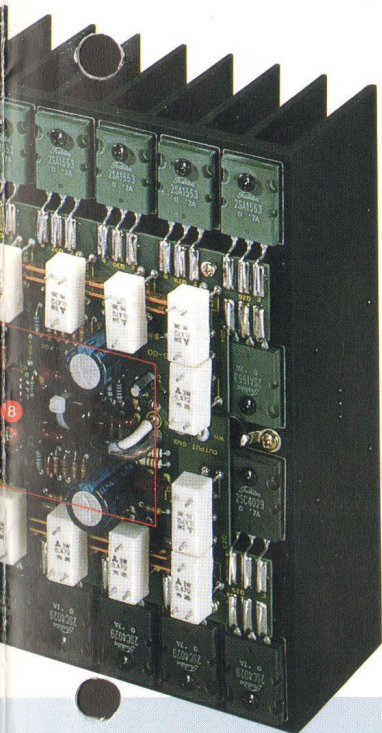

amplifier achieved by two power units

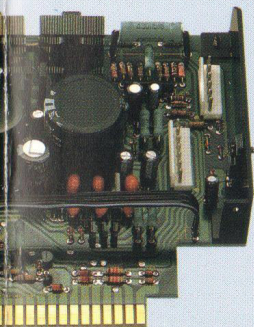

are also mounted on power

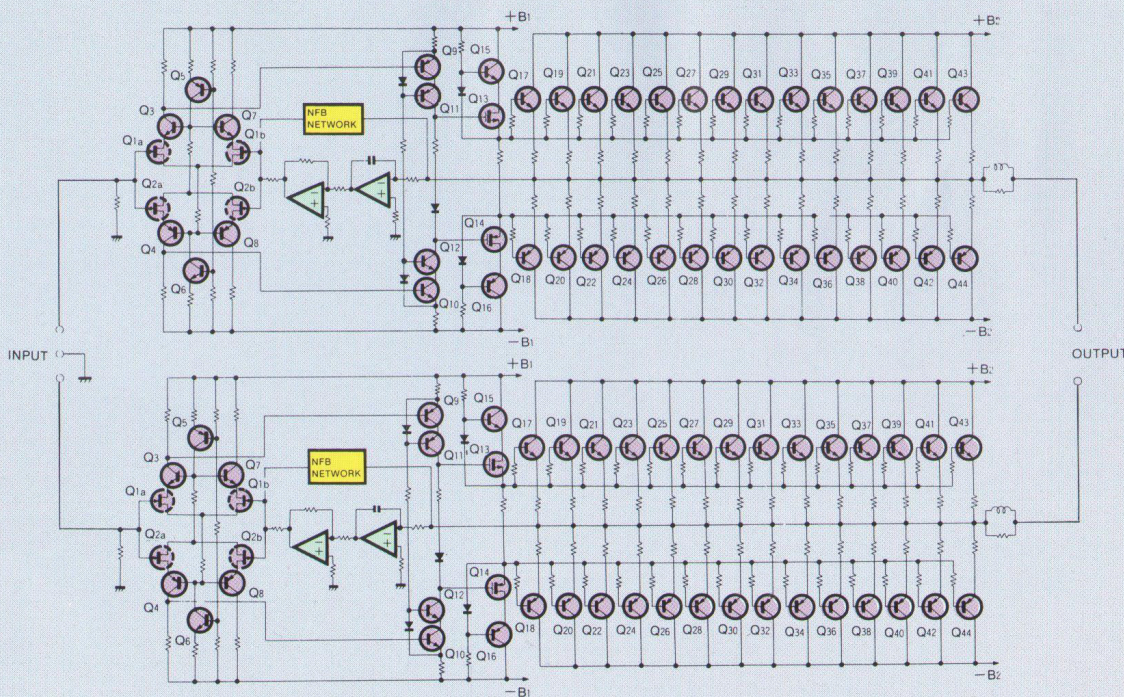

Fig. 2 Block Diagram of M-1000

## 4 Cascode differential push-pull input stage tuned for perfection

To make full use of the performance capabilities of the balanced output stages, the amplifier's input stage must also conform to highest quality standards. To achieve this aim, all Accuphase power amplifiers use a class A cascode differential push-pull circuit configuration in the input stage. As can be seen from Fig. 2, the transistors Q1a and Q3, Q2a and Q4, Q1b and Q7, as well as Q2b and Q8 are cascode connected in both amplifiers. The cascode-connection principle was developed for radio frequency amplification. It guarantees stable operation over a wide range, resulting in outstanding input linearity and wide dynamic range.

## 5 "Cascode push-pull + MOS FET cascode push-pull" drive stage for minimum distortion at low levels and superior high-range stability

The dynamic impact of an orchestra playing at resounding levels and the minute detail of a delicate pianissimo passage – both of these aspects are essential for true music reproduction. With conventional high-power amplifiers, performance at low levels is often found wanting. Not so in the case of Accuphase components, which are built to deliver utterly convincing performance at both ends of the loudness spectrum.

In the output stage, the operating points of the PNP and NPN transistors are carefully adjusted so as to avoid cutoff (current flow interruption), thereby eliminating switching distortion at low signal levels. The final predriver stage employs MOS FET devices, which is equivalent to non-switching class A drive. Cascode push-pull topology further improves performance. The drive current for this stage is supplied by another class A cascode push-pull arrangement. The overall result of this approach is absolutely negligible distortion and totally stable operation from the noise threshold up to full rated power, under any load condition.

## 6 Two power supply units connected in parallel make up a rugged power supply with extremely low impedance

In the M-1000, two power supply units with separate transformers are connected in parallel, yielding a combined capacity of 3 kVA. This design cuts the power supply impedance as seen by the amplifier in half, doubles the maximum current capacity, and corresponds to a filter capacitor arrangement of  $66,000 \mu\text{F} \times 2$ .

## 7 Digital power meter shows true output levels

Output power is indicated by a peak-reading analog meter and a digital meter that shows true current levels. The analog meter is calibrated in decibels and in equivalent power readings. The digital meter circuit senses the actual voltage and current levels delivered to the speaker. An analog multiplier circuit calculates the power for any given moment, which is then precisely displayed on the meter. This newly developed principle provides extremely accurate and useful information for actual operation. The range can be selected in 5 steps: 2 W, 20 W, 200 W, 2,000 W and 10,000 W maximum. Four-hold time choices are provided: 0.5 seconds, 3 seconds,

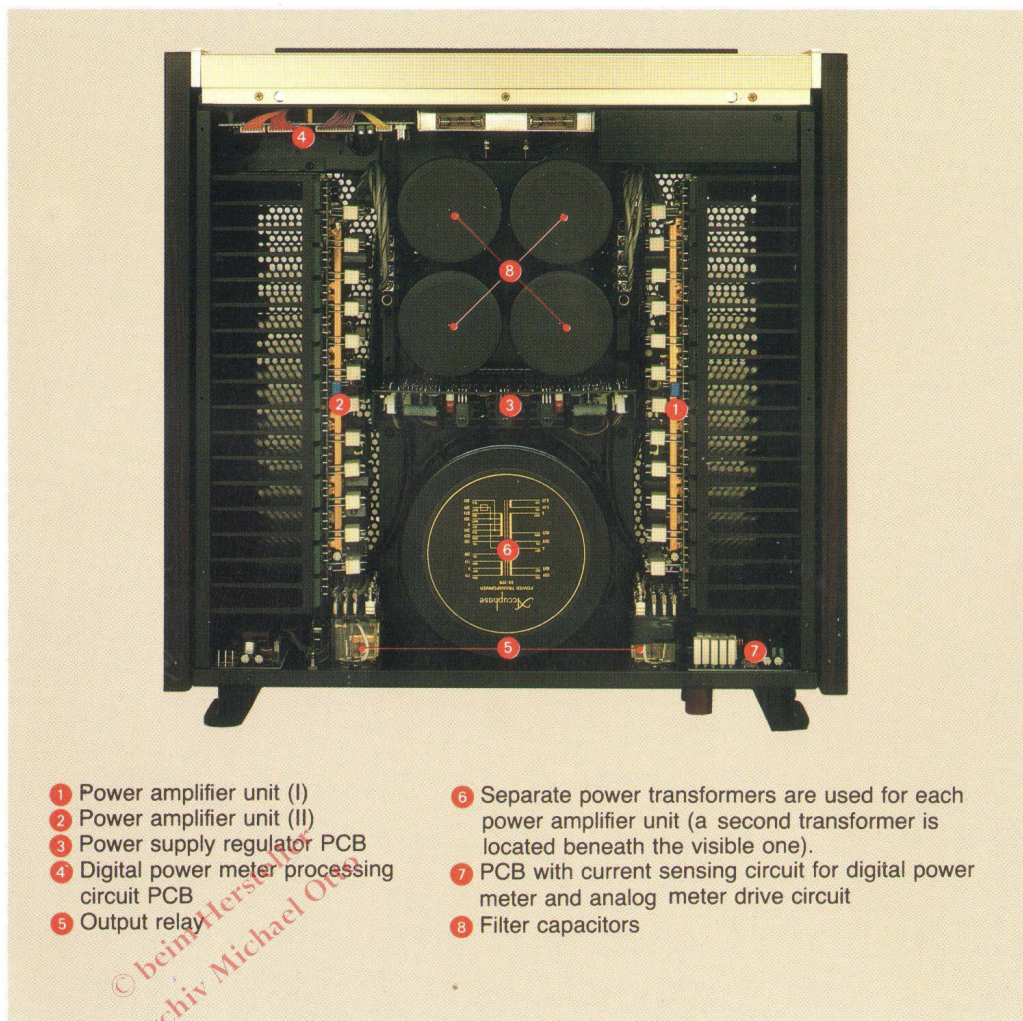

- 1 Power amplifier unit (I)
- 2 Power amplifier unit (II)
- 3 Power supply regulator PCB
- 4 Digital power meter processing circuit PCB
- 5 Output relay
- 6 Separate power transformers are used for each power amplifier unit (a second transformer is located beneath the visible one).
- 7 PCB with current sensing circuit for digital power meter and analog meter drive circuit
- 8 Filter capacitors

75 minutes, and infinite. The 75-minute position is convenient to check the maximum level on an entire CD, and the infinite position shows the maximum level encountered since the amplifier was switched on. (For details on the digital meter, see the separate paragraph.)

## 8 40-kilohm balanced input and 20-kilohm unbalanced phono jack

Although using a preamplifier with balanced output is preferable for optimum performance, the M-1000 will deliver superior quality also with an unbalanced connection using regular RCA-type phono connectors. A switch located on the subpanel on the front side of the amplifier gives a choice of input configurations.

## 9 Mounting provisions for cooling fans

In normal operation, the M-1000 does not require any forced cooling. Only if used in a location where proper ventilation may be obstructed or in professional applications where very high power levels are drawn for long periods, installation of optional cooling fans which can be mounted on the inside of the side panels is recommended. For this purpose, the fan kit O-83 is available from your Accuphase dealer.

## 10 Natural Persimmon-wood Side Panels

Except for the power switch, all controls are located behind a hinged subpanel door in the lower section of the front panel. The panel is finished in brushed gold aluminum, giving the M-1000 an appearance of simple elegance. The visual appeal of the amplifier is further enhanced by the side panels made of exquisite persimmon-wood.

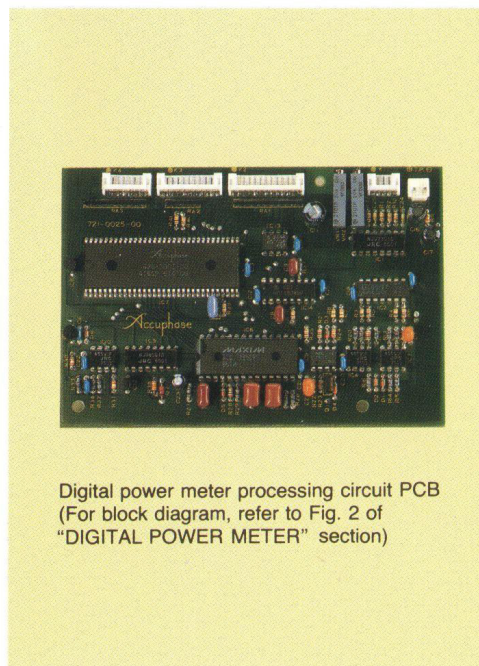

Digital power meter processing circuit PCB  
(For block diagram, refer to Fig. 2 of "DIGITAL POWER METER" section)

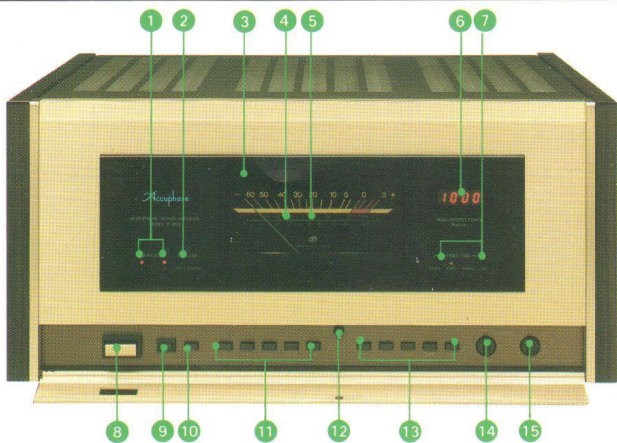

- 1 LED indicators for power amplifier unit operation
- 2 LED indicator for low load impedance drive
- 3 Analog power meter
- 4 Power meter dB scale
- 5 Power meter direct reading wattage scale
- 6 Digital power meter
- 7 LED indicators for digital power meter hold time
- 8 POWER switch
- 9 LOAD IMPEDANCE switch (NORMAL/LOW)
- 10 Analog Power Meter ON/OFF Switch
- 11 Digital power meter POWER RANGE selector (2, 20, 200, 2000, 10,000)
- 12 Subpanel magnet lock
- 13 Digital power meter HOLD TIME selector (OFF, 0.5SEC, 3SEC, 75MIN, ∞)

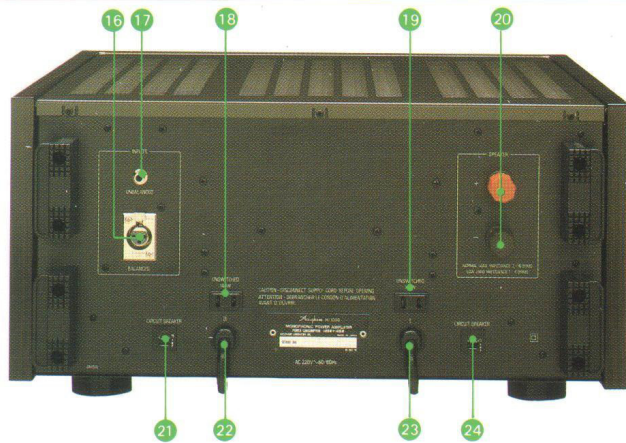

- 14 INPUT selector (BALANCED/UNBALANCED)
- 15 Input level control (1-dB steps to -20 dB)
- 16 Balanced input connector (XLR-3-31 type connector [(1): GND, (2): INVERTED, (3): NON-INVERTED]), suitable for XLR-3-12C type plug
- 17 Unbalanced input jack (input impedance 20 kilohms)
- 18 AC outlet (unswitched)
- 19 AC outlet (unswitched)
- 20 Speaker output terminals
- 21 Circuit breaker for power amplifier unit II
- 22 AC power cord for power amplifier unit II
- 23 AC power cord for power amplifier unit I
- 24 Circuit breaker for power amplifier unit I

## DIGITAL POWER METER

The digital power meter was developed especially for the M-1000. It is a truly revolutionary design which for the first time makes it possible to read actual power values supplied to the load at any given moment, regardless of speaker impedance.

### 1 Innovative circuit indicates actual power supplied to the speaker

The power supplied into the speaker load is defined as the product of voltage at the output terminals (V) and current (I), expressed as  $W = V \times I$ . The voltage can be measured quite easily with a voltmeter, but it is very difficult to determine the current. For this reason, conventional power meters are based on the assumption that the nominal speaker impedance is the load R, calculating current as  $I = V / R$ . Inserting this into the above equation for power yields  $W = V^2 / R$ . However, as is evident from the example shown in Fig. 1, actual speaker impedance is a complex factor that varies considerably with frequency. The peaks and dips in the impedance curve of course cause the current supplied into the load to fluctuate. Measuring only the voltage at the output therefore is not sufficient to obtain true power readings.

The newly developed digital power meter of the M-1000 uses a circuit that senses voltage and current at the output terminals. These values are then converted into power readings by a high-speed, high-precision analog multiplier circuit. Therefore, the power readings are always correct, regardless of fluctuations in speaker impedance.

### 2 Self-correcting display system

With a high-performance metering system such as described above, tolerances of the display circuit are also critical. To achieve high display precision, the M-1000 uses a microprocessor for compensation. At the factory, a highly accurate resistor is used as reference and a calibration value is stored in nonvolatile memory. During

actual operation, a dedicated 8-bit D/A converter performs automatic compensation every 30 seconds. (The compensation process itself requires only 45 milliseconds.) This original design results in a display tolerance of 1% (with 1-kHz actual power reading).

### 3 Operating principle

Fig. 2 shows the block diagram of the digital power meter. First, two circuits sense voltage and current at the load. As the output stages of the M-1000 operate in a bridged configuration, the sensing circuits are fully isolated-ground designs. The current is determined by reading the voltage at both ends of a resistor with ultra-low resistance (10 milliohms). The meter range selector controls an attenuator inserted in this section.

The values for the voltage V and current I are then supplied to the multiplier circuit, to calculate the power W ( $W = V \times I$ ). This component uses a high-precision device with a bandwidth of 10 MHz and a tolerance of only  $\pm 0.5\%$ . Even with single-wave pulse signals of 20 kHz, it performs perfect analog multiplication.

The positive and negative peaks of the resulting power signal are converted to a positive signal by a subsequent absolute-value circuit. The signal then enters a peak hold circuit with a hold time of 0.5 second, to reliably maintain the peak value during conversion. The clear signal serving as clock is a short 1-ms pulse, and the reset circuit uses a power MOS FET for reliable signal removal. This also contributes to high measurement precision.

From the peak hold circuit, the signal is supplied to a 4.5-digit A/D converter, for conversion into a digital signal. Although this circuit yields 4.5 digits, the last number is discarded and the display shows only 3.5 digits, which further increases precision.

The nonvolatile memory contains compensation values which were stored during calibration at

the factory. An 8-bit microprocessor uses this information along with DC drift offset data to control a separate 8-bit D/A converter. This device performs compensation every 30 seconds, to ensure accurate conversion into power levels. The microprocessor also serves for control of the entire display system.

### 4 Functions Power range selection

The display range can be switched with a five-position selector (marked 2, 20, 200, 2,000, 10,000 W), to permit direct readings from 0.001 W to 9,990 W. When the output power exceeds the selected range, the display flashes. The next higher range should then be selected.

### 5 Hold time

Four hold time choices are provided, with buttons marked "0.5 sec", "3 sec", "75 min", and " $\infty$ ". A fifth button serves as clear button and can also be used to switch the display off. To closely observe constantly changing power levels in real time, the "0.5 sec" position is best. The "3 sec" position gives a general indication of peak levels, the "75 min" position is convenient, for example, to check the maximum level on an entire CD, and the " $\infty$ " position preserves the maximum level encountered since the amplifier was switched on for convenient checking at any time.

### 6 Usage examples

The meter of the M-1000 can be used, for example, to check the dynamic range of a program source or the highest peak occurring in a particular musical selection. As the amplifier is driven with a constant voltage, the metering system – in conjunction with an audio signal generator – can even be used to measure the impedance curve of a speaker.

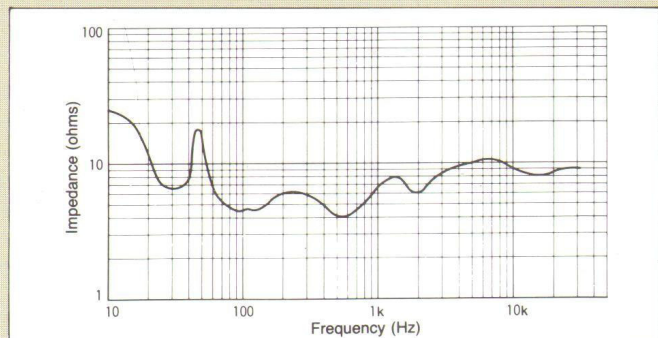

Fig. 1 Impedance curve example (JBL 4345 with rated impedance 8 ohms)

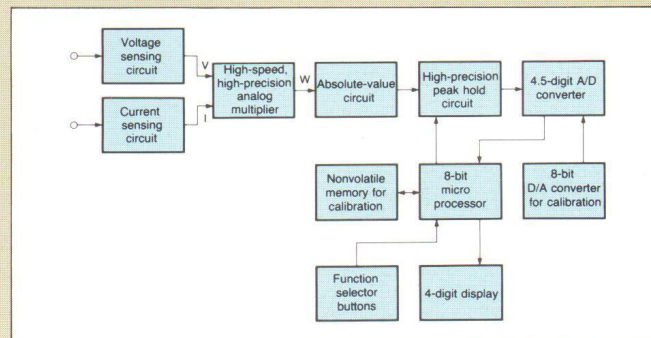
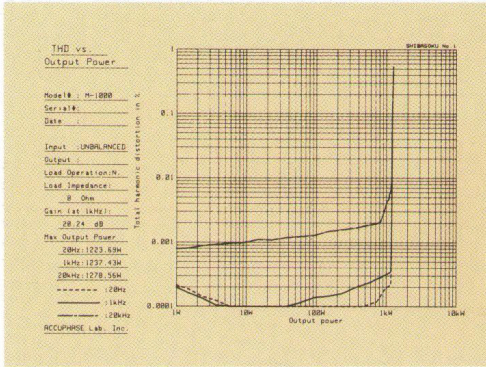

Fig. 2 Block diagram of M-1000 digital power meter

# Accuphase M-1000

MONOPHONIC POWER AMPLIFIER



● OUTPUT POWER vs TOTAL HARMONIC DISTORTION CHARACTERISTIC (at 8 ohms load)

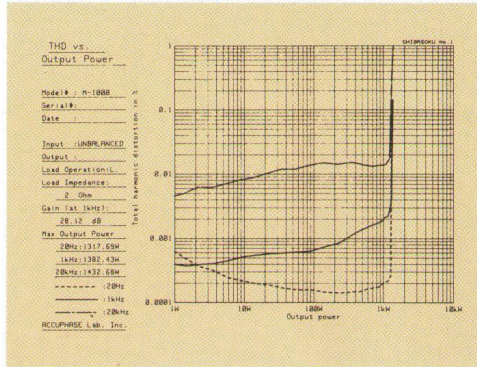

● OUTPUT POWER vs TOTAL HARMONIC DISTORTION CHARACTERISTIC (at 2 ohms load)

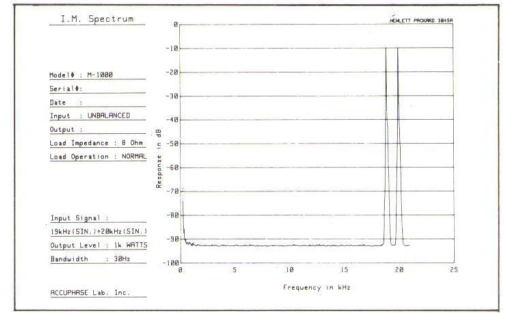

The above graph shows the spectrum of intermodulation distortion characteristic (IHF-IM). Amplitudes of 19 kHz and 20 kHz input signals are shown on the right of the graph. Any intermodulation created by these two signals would appear as spectrum peaks at 1 kHz intervals, the frequency difference between the two signals, across the frequency bandwidth. This data shows them to be hardly noticeable, confirming that IM distortion is less than  $-93$  dB (0.0022%). Another form of IM distortion would appear at 39 kHz, the sum of the two input signal frequencies ( $19 + 20 = 39$  kHz). Such a distortion, even if it existed, would be inconsequential because it is far beyond the audible range. In the P-300V, the form of IM distortion is also less than  $-93$  dB.

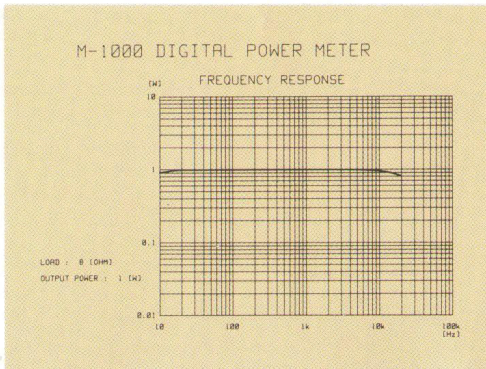

● FREQUENCY CHARACTERISTIC OF DIGITAL POWER METER

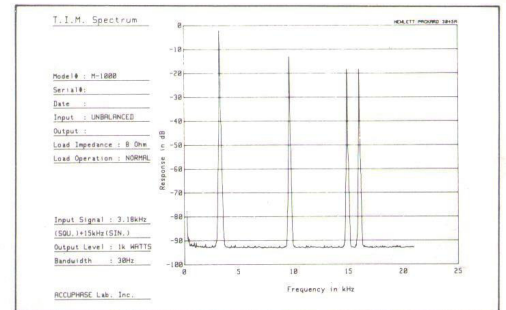

The above graph shows the transient intermodulation distortion (TIM) spectrum. To measure this parameter, a square wave of 3.18 kHz and a sine wave of 15 kHz are mixed and supplied to the input. The square wave signal contains almost infinite odd-number higher harmonics, with components at 9.54 kHz (third harmonic), 15.9 kHz (fifth harmonic), etc. When these components intermodulate with the 15-kHz signal, modulation products show up at frequencies where there is no input signal. For example, if the third harmonic of the 3.18 kHz square wave (9.54 kHz) and the 15 kHz input signal intermodulate, a spectrum can appear at the difference of their frequencies, or at 5.46 kHz ( $15 \text{ kHz} - 9.54 \text{ kHz}$ ). As the graph shows, however, there are no distortion products at all above  $-93$  dB, which means that TIM distortion is less than 0.0022%.

## GUARANTY SPECIFICATIONS (Guaranty specifications are measured according to EIA standard RS-490.)

- **Continuous Average Power Output (20 to 20,000 Hz)**  
NORMAL load impedance operation (THD 0.01%)  
1,800 watts into 4 ohms  
1,000 watts into 8 ohms  
500 watts into 16 ohms  
LOW load impedance operation (THD 0.05%)  
1,600 watts into 1 ohm  
1,100 watts into 2 ohms  
550 watts into 4 ohms
- **Total Harmonic Distortion**  
0.05% with 1 to 4 ohms load  
0.01% with 4 to 16 ohms load
- **Intermodulation Distortion**  
0.003%
- **Frequency Response**  
20 to 20,000 Hz  $\pm 0$  dB  
(for rated output, level control at maximum)  
0.5 to 150,000 Hz  $+0, -3$  dB  
(for 1 watt output, level control at maximum)  
0.5 to 80,000 Hz  $+0, -3.0$  dB  
(for 1 watt output, level control at  $-6$  dB)
- **Gain**  
28.0 dB

- **Output Load Impedance**  
4 to 16 ohms in NORMAL load impedance operation  
1 to 4 ohms in LOW load impedance operation
- **Damping Factor (EIA, 50 Hz)**  
200
- **Input Sensitivity**  
NORMAL load impedance operation  
3.56 V for rated output into 8 ohms  
0.12 V for 1 watt output into 8 ohms  
LOW load impedance operation  
1.87 V for rated output into 2 ohms  
0.06 V for 1 watt output into 2 ohms
- **Input Impedance**  
Unbalanced: 20 kilohms  
Balanced: 40 kilohms
- **Signal-to-Noise Ratio (A-weighted)**  
125 dB with input shorted, at rated output  
95 dB with 1-kilohm input termination, at 1 W output
- **Analog Output Level Meter**  
Logarithmic compression scale, peak reading,  $-60$  dB to  $+3$  dB and direct watt-reading scale
- **Digital Output Meter**  
Type: True power readings  
Display range: 0.001 W to 9.990 W, switchable range,

- direct reading  
Effective digits: 3.5  
Range: 2 ; 0.001 - 1.999 watts  
20 ; 0.01 - 19.99 watts  
200 ; 0.1 - 199.9 watts  
2000 ; 1 - 1,999 watts  
10000 ; 10 - 9,990 watts
- Tolerance:  
Below 2,000 watts  $3\% \pm 5$  counts  
2,000 watts or above  $3\% \pm 50$  counts  
Hold time: 0.5 s, 3 s, 75 m,  $\infty$
- **Semiconductor Complement**  
99 transistors, 13 FETs, 31 IC's, 142 diodes
- **Power Requirements**  
100 V, 117 V, 220 V, 240 V 50/60 Hz AC
- **Power Consumption**  
120 watts + 120 watts idle  
800 watts + 800 watts at rated power output into 8 ohms
- **Dimensions**  
481 mm (18-15/16 inches) width, 239 mm (9-13/32 inches) max. height, 489 mm (19-1/4 inches) depth
- **Weight**  
47.2 kg (103.8 lb) net, 55.2 kg (121.4 lb) in shipping carton

