

Accuphase

PRECISION STEREO PREAMPLIFIER

C-290

● Superior balanced line amplifier ● All-stage class-A push-pull design with low-noise input module ● PPO printed circuit boards ● Complete mono construction with separate amorphous-core transformers ● Four-gang volume control with CP resistor elements



Hersteller
Michael Otto

© beim Hersteller
Archiv Michael Otto

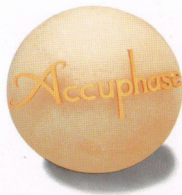

Full-floating balanced line amplifier assures ideal performance characteristics.
All-stage class-A push-pull design with low-noise input module.
Printed circuit boards made of PPO resin with low dielectric constant.
Complete mono construction with separate amorphous-core transformers.
Four-gang volume control with CP resistor elements.
Optional phono equalizer unit for analog disc reproduction.

The most important task of a preamplifier is to faithfully reproduce the sound of a program source. With the sonic evolution of the CD and other high-quality sources, this has become even more essential. Accuphase has always been a champion of quality, as exemplified by our dedication to the balanced transmission principle. It is no coincidence that the C-280V preamplifier with its perfect balanced line amplifier has been praised the world over as representing the pinnacle of preamplifier design.

The C-290 now takes the balanced transmission technology developed for the C-290 to an even higher plane of perfection. All aspects of circuit topology were reexamined, and only the very best parts and materials were used to create this masterpiece. We are proud to have once again redefined the state of the art in preamplifier design.

In view of today's program sources, the C-290 was developed into a line amplifier that is the epitome of purity. But we have not forgotten the traditional side, either. Among other things, Accuphase is famous for giving full play to analog disc reproduction, and the C-290 is no exception. For audiophiles with a valued analog disc collection, the optional phono equalizer unit provides an ideal way to enjoy the best of two worlds. The add-on unit fits into a dedicated compartment on the rear of the amplifier and offers two inputs for MM or MC cartridges.

One of the most notable features of the C-290 is the fact that the sonic performance of its line amplifier is equally outstanding with balanced as well as unbalanced input and output connections. The balanced output stage employs a symmetrical cross-feedback design that results in a full-floating balanced circuit of the highest order where the signal path does not

depend on the ground line. The differential complementary push-pull stage is executed as a high-performance module which provides reliable protection against noise and enhances temperature stability and reliability. For the printed circuit boards, which are highly important components affecting electrical and sonic performance, polyphenylene oxide (PPO) with printed circuit pattern of gold-plated copper is used, resulting in a definite sound quality improvement.

The various unit amplifiers are housed in massive aluminum enclosures which are mounted on a motherboard and in turn the motherboard is firmly mounted on an 8-mm thick chassis made of hardened aluminum. This provides perfect protection against electrical and mechanical interference and vibrations. Complete mono construction with two sets of power transformer and filtering capacitors prevents unwanted interaction between the stereo channels, to assure absolutely stable operation.

The C-290 fully reflects the fact that the power supply of a preamplifier is of vital importance. The power transformers employ an amorphous core material with non-crystalline structure, which yields excellent frequency characteristics and keeps magnetic distortion at a minimum.

The volume control is a four-gang type with conductive plastic (CP) resistor elements. This provides attenuation that is virtually free of sonic degradation and other unwanted side effects. Logic-controlled relays are arranged close to the input and output connectors, in order to allow the shortest possible signal paths. The hermetically sealed relays are filled with nitrogen gas, for outstanding reliability and long service life.

The optional phono equalizer unit features the same superior circuit topology as used

in the C-280V, with dedicated input stages for MM and MC cartridges. Of course, high-quality PPO circuit boards are used, to assure analog disc reproduction of the highest order.

Whether one considers circuit design, materials, parts, or workmanship, the C-290 is nothing less than perfect. Its sonic excellence lets the connoisseur rediscover the true meaning and pleasure of high-end audio.

The ultimate balanced line amplifier

Accuphase has for a long time advocated the balanced transmission principle. Therefore it is a matter of course that the C-290 should offer perfectly balanced circuit design at least on the order of the C-280V. In balanced signal transmission, two identical signals are transmitted simultaneously with inverted phase and combined at the receiving end, thereby canceling out common-mode noise. This principle assures ideal transmission characteristics, since any extraneous components such as RF interference from other equipment and other types of noise are canceled and cannot affect the sonic purity of the signal path. For this reason, broadcast studios and other professional facilities where extended cable lines are inevitable have long been using balanced transmission. Recently, this principle is gaining increased popularity also in the home, since there are many possible sources of electrical and air-borne high-frequency noise which can enter the

operation, the (+) (-) signal is connected to both inputs of AMP 1, where it is amplified and then sent to AMP 2 and AMP 3. These two amplifiers employ cross feedback whereby the output of one amplifier is sent to the input of the other, which assures that the symmetrical (+) (-) signal is sent to the next component with low impedance. An important characteristic of the circuit in the C-290 is that the symmetrical (+) (-) signal does not depend on the ground. Therefore, even if one side of the output is grounded line, both amplifiers remain operative, and output voltage does not change. When a component with unbalanced output is connected, it suffices to simply ground one side of the input and output, to handle the signal with most of the benefits of a balanced amplifier.

All-stage class-A push-pull design and low-noise modular construction

Fig. 3 shows the circuit diagram of the line amplifier. All unit amplifiers employ the symmetrical push-pull design developed by Accuphase. The input stage is executed as a cascode source follower arrangement that provides ultra-stable operation up to extremely high frequencies. The subsequent stage is a differential complementary push-pull amplifier whose entire circuitry is contained in a module and mounted on an alumina ceramic substrate with superior high-frequency and heat transmission characteristics. This keeps noise at a minimum and assures excellent electrical and thermal stability. The output stage is a complementary Darlington push-

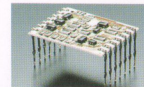

pull design with low impedance and greatly enhanced linearity.

PPO printed circuit boards with low dielectric constant

The printed circuit boards consist of polyphenylene oxide (PPO) on a glass substrate. This material has similar electrical properties as POLYTETRA FLUORO ETHYLENE, with a low dielectric constant and superior high-frequency characteristics up to 12 GHz.

The printed circuit board is an important consideration, since it must provide good mechanical support as well as reliable and efficient electrical connectivity for the circuit components. Because a circuit board inevitably is to a certain extent a dielectric, it can act like a capacitor. To counter this tendency, it is vital to choose a material that provides all the required physical properties while having a low dielectric constant. Based on a series of extensive tests, PPO was found to fulfill these requirements, and therefore this material was chosen for the C-290. To further enhance reliability and sound quality, all copper printed patterns on the circuit boards are gold-plated.

Complete mono construction with separate amorphous-core transformers for left and right channels

The power supply of the C-290 also offers nothing but the best. Two completely separate sets of transformers and filtering capacitors preclude any possibility of electrical interaction between the channels. In addition, each unit amplifier has its own wide-range voltage regulator circuitry, to eliminate possible interference between stages.

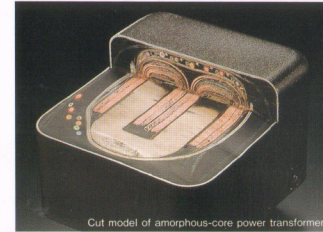

The power supply circuitry consists of the power cord, power transformer, rectifiers, and filter capacitors. Although the power line frequency is only 50 or 60 Hz, tests have shown that the sound quality of an amplifier improves if fast recovery diodes are used as rectifiers. A possible reason for this phenomenon lies in the fact that the amplifier circuits have to handle signals in the range from 20 to 20,000 Hz, and the energy source for these circuits is affected because the load current also fluctuates at this rate. The power transformers of the C-290 therefore employ an amorphous alloy core which assures high operation stability even at high frequencies.

Amorphous alloys are produced by a rapid cooling and rolling process of melted metal which results in a non-crystalline structure. Compared to crystalline metals, this provides advantages in magnetic as well as mechanical properties. The main features of amorphous alloys are:

- High magnetic flux density means higher current handling capability.
- High Curie point means high stability against temperature fluctuations.
- Low hysteresis loss, eddy loss, and other losses

A 25-micron Fe-group amorphous plate is rolled into a core for the transformers of the C-290.

Four-gang volume control with CP resistor elements

The volume control is an important component which can have a decisive influence on sound quality. The C-290 therefore uses CP (conductive plastic) resistor elements which have proven their worth in the C-280V. The volume control elements are

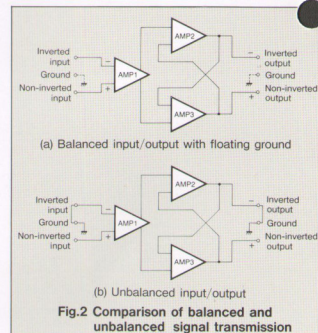
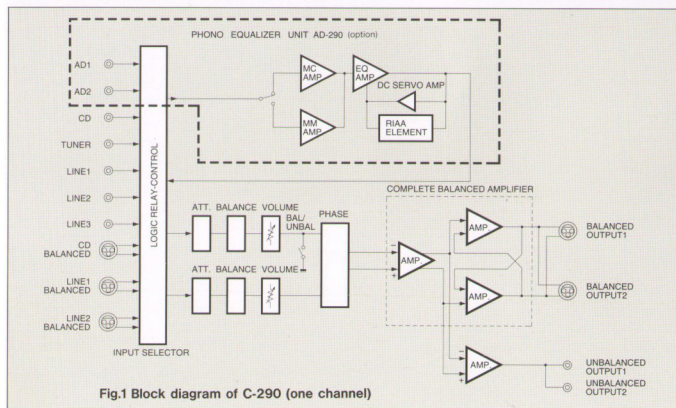

cables of audio components and cause sound quality degradation. Balanced signal transmission reliably guards against this danger, making it an important requirement for true high fidelity. The balanced line amplifier in the C-290 carries the balanced principle to its fullest consequence, in order to provide perfect balanced output. Fig. 2 shows the amplifier during balanced operation (a) and unbalanced operation (b). A total of three differential amplifiers are used. During balanced

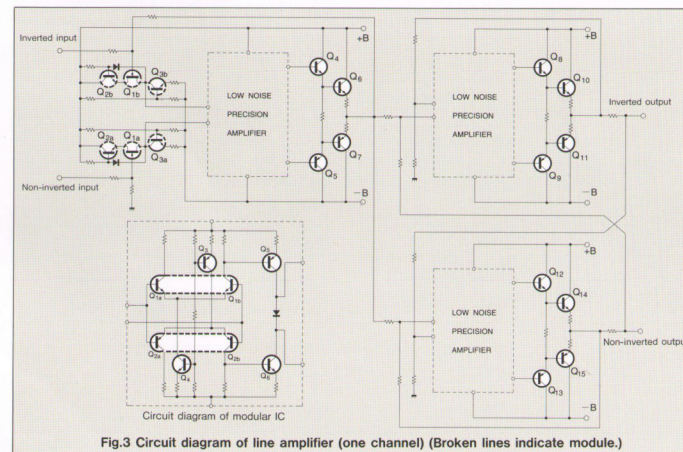



Internal layout

- 1 Amorphous-core Power Transformer
- 2 Left and right-channel power supply filter capacitors
- 3 Left and right-channel line amplifier units
- 4 Left and right-channel balanced amplifier units
- 5 Dedicated Phono Equalizer Unit AD-290 (option)

■ Motherboard with gold-plated copper traces carries four unit amplifiers as well as filtering capacitors and peripheral circuitry.

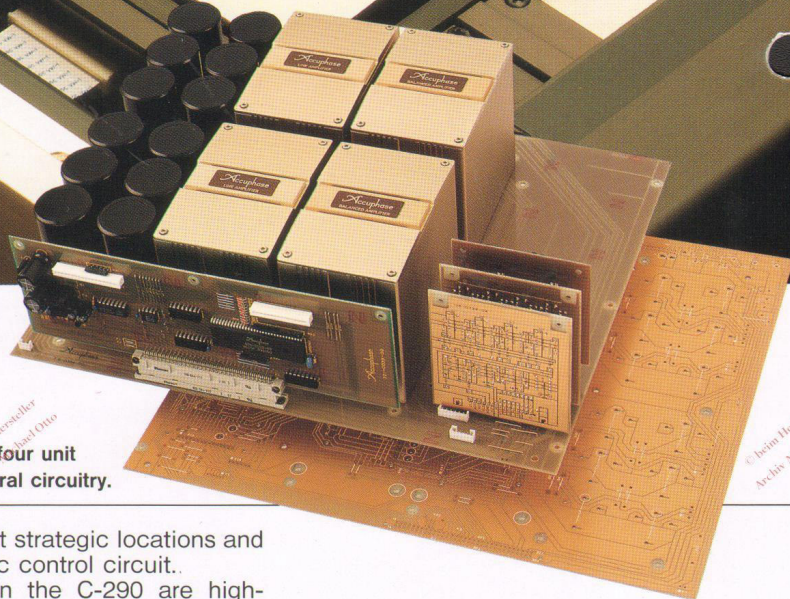

produced by a printing process followed by a forming stage under high pressure at high temperature. This creates a mirror-like surface with minimum contact resistance and negligible distortion. The contact brush is gold-plated to eliminate any possibility for sound quality deterioration. Another innovative aspect of the volume control is the fact that turning the volume knob rotates the resistor element assembly, while the contact brush remains stationary. This drastically reduces the number of internal contact points and eliminates the need for contact grease. The extra-large shaft has a diameter of 8 mm and is made from pure brass material. It is supported by a bearing of aluminum processed by cutting method, and each of the four resistor layers is housed in its own aluminum cut-out enclosure, to provide perfect shielding and ideal VR characteristics. The tracking error is as low as 0.5 dB at the -60 dB position.

Logic-controlled relays for signal switching assure high sound quality and long-term reliability

If the input signals from the rear of the amplifier are routed to the front panel for switching, various unwanted effects are bound to degrade sound quality. This means that short signal paths are essential for optimum operation, and switching should occur at the points which allow the shortest connection. Protecting the switch contacts from corrosion such as caused by sulphur gases in the atmosphere, air-borne cigarette smoke particles, etc. is also very important. The C-290 therefore uses the Accuphase approach, whereby special

relays are placed at strategic locations and governed by a logic control circuit. The relays used in the C-290 are high-performance types which were developed for demanding audio and data transmission applications. They are filled with nitrogen gas and sealed hermetically. The contacts are twin crossbar types plated with gold and silver palladium alloy, for minimum contact resistance and outstanding long-term reliability.

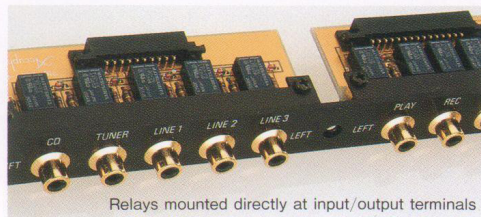

Relays mounted directly at input/output terminals

Vibration-free design with unit amplifiers in aluminum enclosures and 8-mm hardened aluminum chassis

The main amplifier sections of the C-290 are divided into a total of four unit amplifiers, two each for the line amplifier and balance amplifier in each channel. Each unit is powered by its own local voltage regulator circuitry, and is housed in a strong aluminum enclosure, to prevent interference between units. The output and voltage-regulation devices are directly fastened to the enclosure, which provides efficient heat dissipation and suppresses vibrations and resonances. The various units are screw-mounted to a sturdy glass epoxy mother PCB and fixed to

an 8-mm chassis made from hardened aluminum. This provides rock-stable support and guarantees perfect electrical and mechanical isolation as well as superior resistance against vibrations and other unwanted effects.

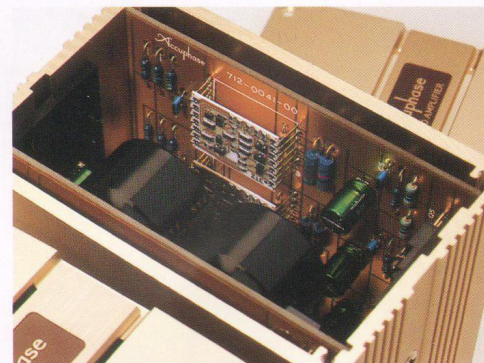

Unit amplifier with PPO printed circuit board housed in massive aluminum enclosure

Twelve inputs and six outputs with alphanumeric source display

To accommodate today's enormous variety of program sources, the C-290 offers an ample number of inputs and outputs. Nine unbalanced inputs for RCA-type phono jacks (CD, Tuner, Line \times 3, Tape \times 2, plus optional analog disc \times 2) are augmented by three balanced inputs (one for CD and two additional balanced line inputs). The selected input is shown on the front panel

by an easy-to-read character display. The six outputs include two balanced and two unbalanced outputs and two tape outputs.

High-precision balance control with numeric indication

To allow perfect channel matching and optimum balance at any listening position, the C-290 incorporates a pushbutton balance control with precision attenuators operating in 1-dB increments. The adjustment range is 0 to -6 dB and $-\infty$. Adjustment values are shown on the front panel.

Phase switching without sound quality degradation

The overall phase of the entire amplifier can be inverted with a Phase switch. Switching is performed by changing the (+) (-) assignment of the balanced amplifier, which avoids the sonic degradation caused by the circuit load of conventional phase inverters.

Other features

Another important function of a preamplifier is easy and versatile tape recorder control. The C-290 has provisions for record/playback connection and monitoring of two tape recorders.

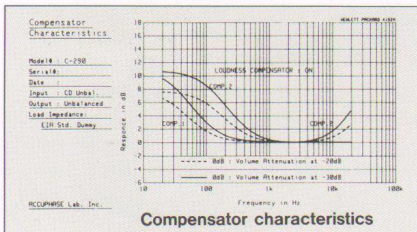

At low listening levels, the human ear becomes less sensitive to the frequency extremes, which can make the music sound thin and hollow. The two-step loudness compensator switch of the C-290 provides correct compensation, depending on the position of the volume control. This restores a natural listening impression regardless of volume.

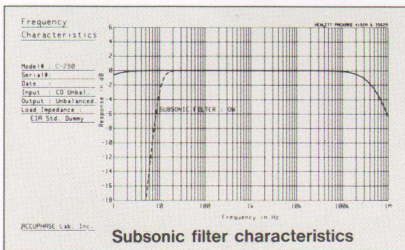

A switchable subsonic filter is an essential requirement for the reproduction of analog records. The C-290 has a high-quality filter with a turnover frequency of 10 Hz and a cutoff slope of -18 dB/octave. This removes harmful low-frequency rumble without affecting the audible range.

Dedicated Phono Equalizer Unit AD-290

In its standard configuration, the C-290 is designed as a preamplifier mainly for high-quality digital sources. But audiophiles who own a valued collection of analog records can also take advantage of the superior sonic potential offered by the C-290. The phono equalizer unit AD-290 plugs into a dedicated compartment on the rear of the C-290 and offers phono reproduction quality of the highest order.

The AD-290 features the same PPO circuit board technology as the C-290 and is housed in a sturdy aluminum enclosure to minimize the possibility of noise intrusion. The two inputs are connected to the initial stage by the shortest possible connection, to maintain flawless S/N ratio. Highly reliable DIN connectors are used for connection to the C-290, and all function switching operations are carried out from the front panel of the C-290.

Fig. 4 shows the "all-symmetrical push-pull"

circuit principle of the phono equalizer unit. Separate MM and MC input stages provide optimum operating conditions for each cartridge type. The moving-magnet input uses an arrangement of four FETs (Q₁ - Q₄) with high S/N ratio, which is ideal for cartridges with high output impedance. The moving-coil input on the other hand, which has to process very low-level signals from cartridges with low output impedance, is configured as a low-noise differential circuit (Q₅ - Q₁₂) with a low-impedance NFB loop. An impedance switch provides a choice between an MC input impedance of 10, 30, and 100 ohm. The MM input impedance is fixed at 47 kΩ. Gain is switchable between 62 and 68 dB for MC cartridges and 30 and 36 dB for MM cartridges. Since all switching functions are controlled from the front panel of the C-290, operation is exactly identical to components with built-in phono preamplifiers.

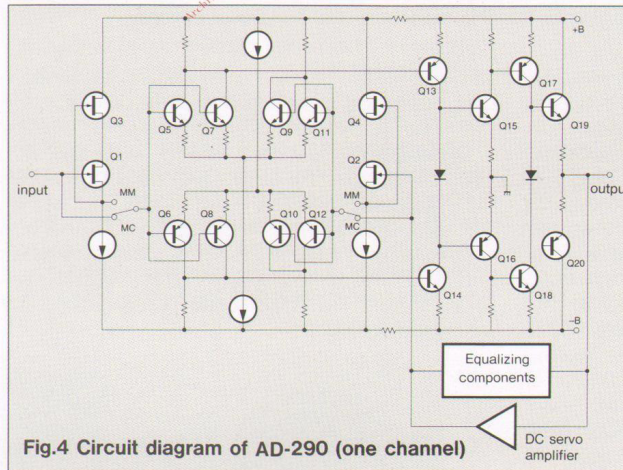
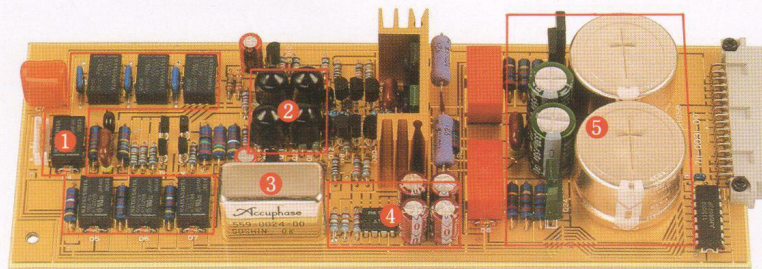

Fig.4 Circuit diagram of AD-290 (one channel)



Dedicated phono equalizer unit AD-290



- AD-290 Assembly (one channel)
- 1 MM/MC switching relay
- 2 Differential input amplifier circuitry
- 3 Equalizing components
- 4 DC servo circuit
- 5 Low-noise power supply circuitry

FRONT PANEL

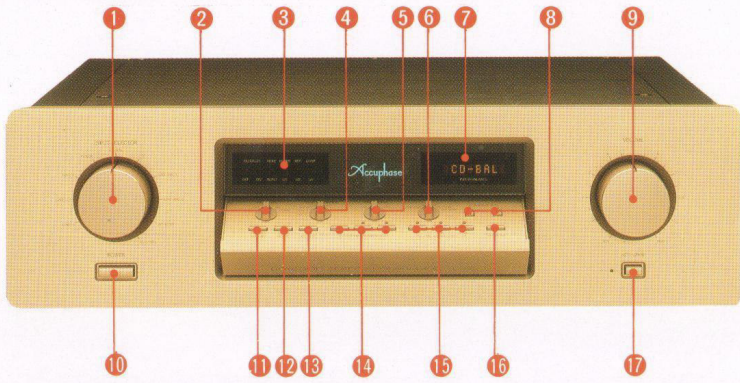

- 1 Input selector
- 2 OUTPUTS selection switch
- 3 Function LEDs
- 4 Recording output on/off tape monitor switch
- 5 TAPE COPY switch
- 6 EQUALIZER GAIN switch
- 7 Input/Balance Character Display
- 8 Balance Adjustment Buttons
- 9 VOLUME control
- 10 POWER switch
- 11 Output Phase Selector
- 12 Stereo/Mono Mode Selector
- 13 SUBSONIC FILTER switch
- 14 COMPENSATOR switch
- 15 MC cartridge load impedance switch
- 16 Display Mode Selector INPUT/BALANCE/OFF

REAR PANEL (OPTION:AD-290)

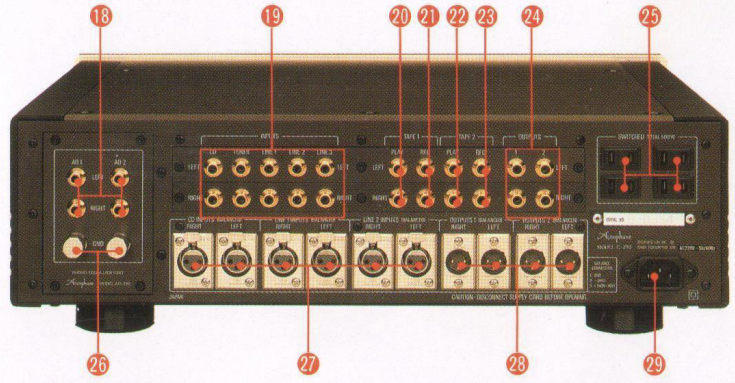

- 17 Attenuator switch
- 18 AD (analog disc) input jack
- 19 Line input jack
- 20 TAPE-1 tape input jack
- 21 TAPE-1 recording output jack
- 22 TAPE-2 tape input jack
- 23 TAPE-2 recording output jack
- 24 Unbalanced output jack
- 25 AC outlet (switched)*
- 26 Ground Terminal
- 27 Balanced input CD/LINE connectors
- 28 Balanced output connectors
- 29 AC power connector

Remarks
*These switched AC outlets may not be supplied depending on the safety standards or regulations applicable in the particular country to where the unit is destined.

GUARANTEED SPECIFICATIONS

※ Guaranteed specifications are measured according to EIA standard RS-490. AD denotes Analog Disc input.

※ Specifications are measured with phono equalizer unit AD-290 installed.

Frequency Response

- BALANCED INPUT (CD, LINE)
3 to 350,000Hz +0, -3.0dB
20 to 20,000Hz +0, -0.2dB
- UNBALANCED INPUT (CD, TUNER, LINE, TAPE PLAY)
3 to 350,000Hz +0, -3.0dB
20 to 20,000Hz +0, -0.2dB
- AD INPUT : [MM/36dB,MC]
20 to 20,000Hz ±0.2dB
- AD INPUT : [MM/30dB]
20 to 20,000Hz ±0.3dB

Total Harmonic Distortion

0.005% (for all inputs)

Input Sensitivity, Input Impedance

Input	Sensitivity		Input impedance
	Rated output	0.5 V output	
AD:MM/30dB	4.0mV	1.0mV	47k Ω
AD:MM/36dB	2.0mV	0.5mV	47k Ω
AD:MC/62dB	0.1mV	0.025mV	10 Ω · 30 Ω · 100 Ω
AD:MC/68dB	0.05mV	0.0125mV	10 Ω · 30 Ω · 100 Ω
BALANCED	252mV	63mV	40k Ω
UNBALANCED	252mV	63mV	20k Ω

Rated Output Level and Impedance

- BALANCED OUTPUT : 2.0V, 50 Ω XLR connector
- UNBALANCED OUTPUT : 2.0V, 50 Ω RCA-type phono jack
- TAPE REC : 252mV, 200 Ω AD source/RCA-type phono jack

S/N Ratio

Input terminal	Input shorted, IHF-A weighting S/N ratio at rated output	S/N ratio (EIA)
AD:MM/30dB	94dB	86dB
AD:MM/36dB	90dB	86dB
AD:MC/62dB	80dB	85dB
AD:MC/68dB	75dB	85dB
BALANCED	111dB	95dB
UNBALANCED	111dB	95dB

Maximum Output Level (THD 0.005%, 20~20,000Hz)

- BALANCED OUTPUT : 8.0 V (XLR connector)
- UNBALANCED OUTPUT : 8.0 V (RCA-type phono jack)
- TAPE REC : 9.5 V (AD source, RCA-type phono jack)

Maximum AD Input Level (1 kHz, THD 0.005%)

- MM/30 dB : 300mV
- MM/36 dB : 150mV
- MC/62 dB : 7.5mV
- MC/68 dB : 3.75mV

Minimum Load Impedance

- BALANCED OUTPUT : 600 Ω
- UNBALANCED OUTPUT : 600 Ω
- TAPE REC : 10k Ω

Gain

- BALANCED INPUT → BALANCED OUTPUT : 18 dB
- BALANCED INPUT → UNBALANCED OUTPUT : 18 dB
- UNBALANCED INPUT → BALANCED OUTPUT : 18 dB
- UNBALANCED INPUT → UNBALANCED OUTPUT : 18 dB
- UNBALANCED INPUT → REC OUTPUT : 0 dB
- AD (MM 30/36 dB) → BALANCED OUTPUT : 48/54 dB
- AD (MM 30/36 dB) → UNBALANCED OUTPUT : 48/54 dB
- AD (MM 30/36 dB) → REC OUTPUT : 30/36 dB
- AD (MC 62/68 dB) → BALANCED OUTPUT : 80/86 dB
- AD (MC 62/68 dB) → UNBALANCED OUTPUT : 80/86 dB
- AD (MC 62/68 dB) → REC OUTPUT : 62/68 dB

Loudness Compensator Characteristics (volume setting -30 dB)

- 1 : +3dB (100Hz)
- 2 : +8dB (100Hz), +6 dB (20kHz)

Subsonic Filter Characteristics

Cutoff frequency 10Hz, -18dB/octave

Attenuator Characteristics

-20dB

Power Requirements

100V, 117V, 220V, 240V 50/60Hz AC

Power Consumption

30 watts

Maximum Dimensions

- 475mm (19-2/5") width
- 149mm (5-9/10") height
- 405mm (16-1/2") depth.
- 414mm (16-9/10") depth (with AD-290)

Weight

- 23.8kg (52.5lbs.) net
- 24.8kg (54.7lbs.) (with AD-290) net
- 28.8kg (63.4lbs.) in shipping carton
- 29.8kg (65.6lbs.) (with AD-290) in shipping carton

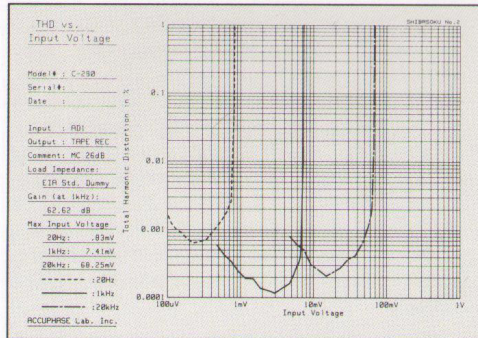

Input voltage vs. THD (MC input to tape output)

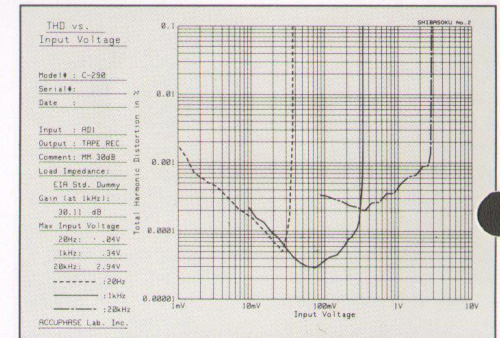

Input voltage vs. THD (MM input to tape output)

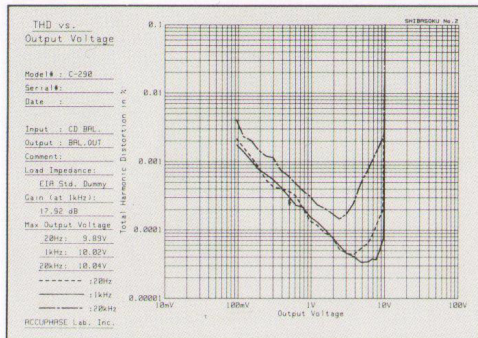

Output voltage vs. THD
(Balanced CD input to balanced output)

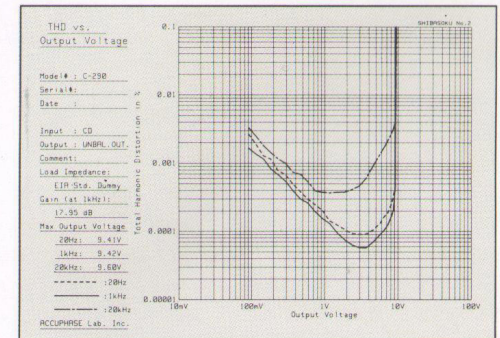

Output voltage vs. THD
(Unbalanced CD input to balanced output)



ACCUPHASE LABORATORY INC.