

AKG

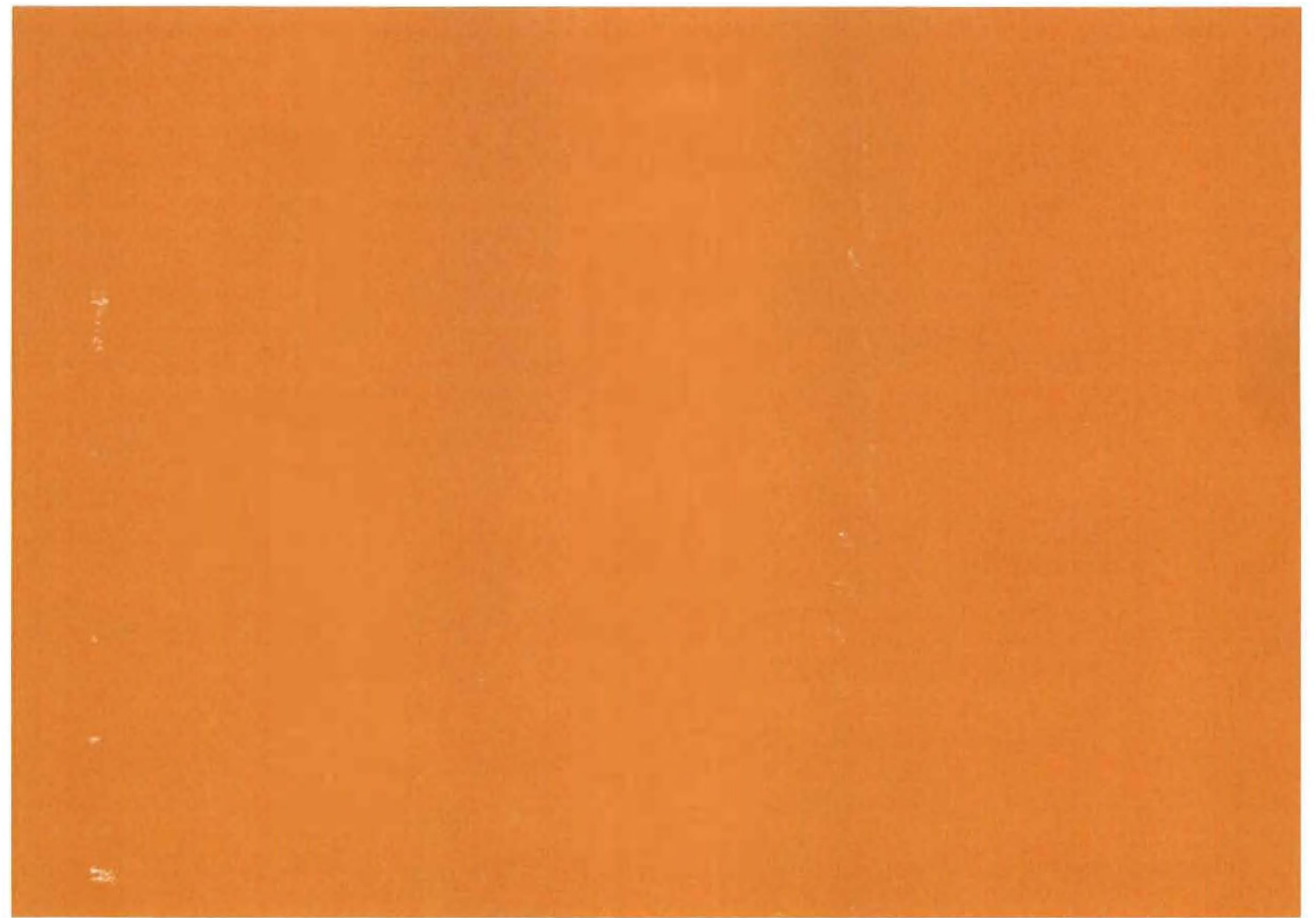

**PROFESSIONAL
CONDENSER AND DYNAMIC
MICROPHONES • HEADPHONES**

AKG C-24 stereo condenser microphone system



C-24



DESCRIPTION

The C-24 was specially designed for intensity stereo recording techniques in the XY or MS mode. Two twin-diaphragm condenser microphone capsules are mounted within the microphone body, with a spacing of only $1\frac{1}{2}$ " , making any difference in time between the two outputs negligible. The upper microphone system may be rotated 180° to provide any offset angle desired. Nine different directional patterns can be remotely selected for each of the two twin-diaphragm capsules. These patterns are identical as to their phase relationship and sensitivity and maintain their polar characteristics independent of frequency. The patterns are a/omni directional, b/ cardioid and c/ figure-eight, plus 6 intermediary positions.

The stand connector is designed to facilitate rapid and accurate change-over from MS to XY stereo recording technique. A window indicates the symbol MS and upon rotating the stand connector by 45° counter-clockwise the symbol XY indicates the correct XY position.

The C-24 system consists of microphone preamplifier with two twin-diaphragm capsules, S-24 dual remote control pattern selector, N-24 a.c. power supply, MK-24/20 cable for connecting microphone and power supply, RL-24/10 cable to connect power supply with pattern selector plus NF-24 audio cable. The unit is being delivered with individual response curves for both capsules, recorded in the three basic patterns.

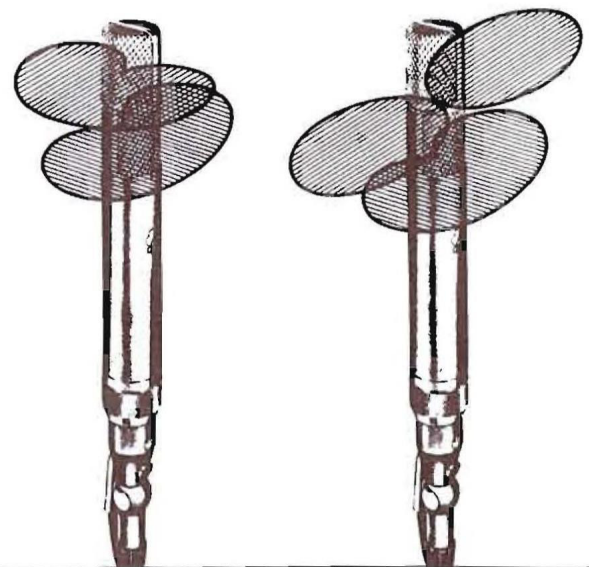

XY

MS

technical data

SPECIFICATIONS

Sensitivity

: 1 mV/ μ bar
 = -41 dB (RE 1mw/10 dyne/cm²)

Electrical impedance at 1,000 Hz

: 200 ohms \pm 15%
 Convertable to 50 ohms \pm 15%

Minimum actual load impedance

: \leq 500 ohms (\leq 150 ohms)

Weighted noise level

: 2.5 μ v_{eff} (Filter CCIF 1954 DIN 45405)

Unweighted noise level

: 8.0 μ v_{eff}

Equivalent noise level

: \leq 22 dB (Filter CCIF 1954 DIN 45405)

Maximum Sound Pressure level

: at a harmonic distortion of 0.5%:
 150 μ bar (117.5 dB SPL)

Tube

: 6F602

Plate voltage

: 120 V

Power Supply

: 110 V \pm 10%, convertible
 220 V \pm 10%, 50-60 Hz

Matrix for attenuating the signal to expand or contract the width of M or S image. For use between S-24 and mixing console input.

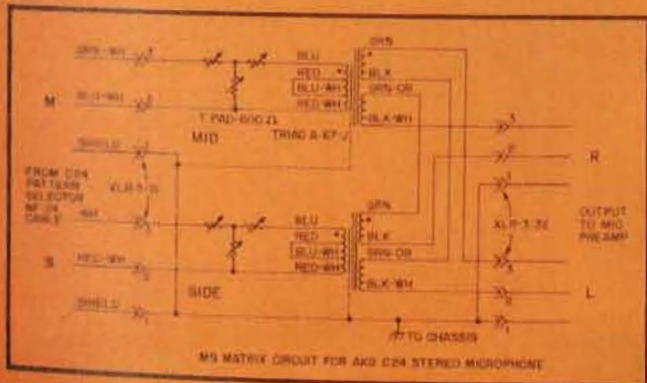

Guarantee frequency response curve

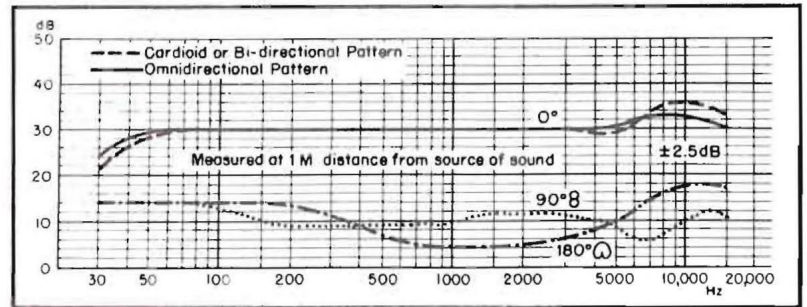

Polar diagrams (photographs), taken from 1 m distance from the source of sound. Directional characteristic: Position "Omnidirectional"

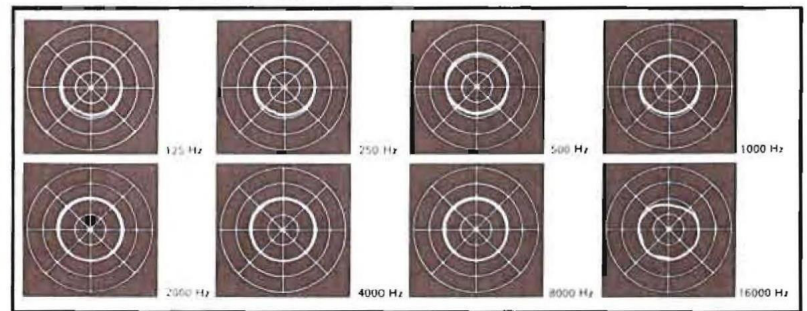

Polar diagrams (photographs), taken from 1 m distance from the source of sound. Directional characteristic: Position "Cardioid"

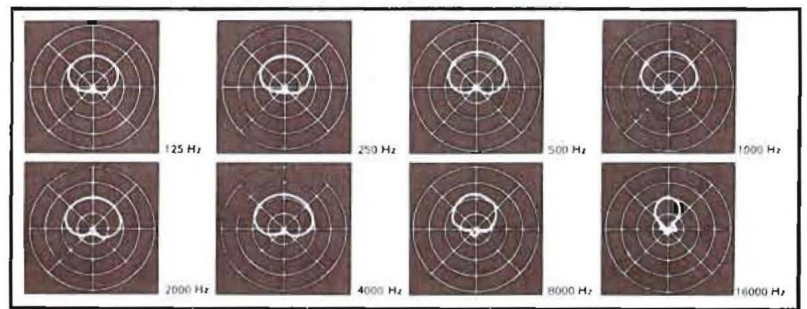

Polar diagrams (photographs), taken from 1 m distance from the source of sound. Directional characteristic: Position "Figure-of-eight"

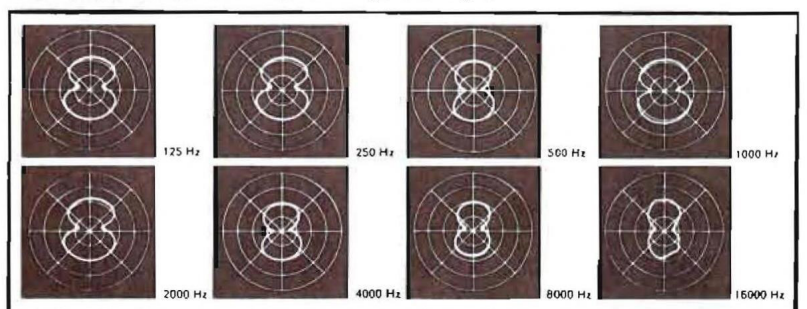

AKG C-412 and C-414 condenser microphone systems



C-412



C-414

DESCRIPTION

The AKG C-412 and C-414 are professional studio condenser microphones designed to meet the highest requirements in any recording application.

Both microphones incorporate a 1" twin-diaphragm condenser microphone capsule which permits selection of polar patterns by means of a switch located on the microphone body.

The C-412 has three selectable patterns:

- 1) Omni-directional
- 2) Cardioid
- 3) Figure-eight

The C-414 permits selection of four directional patterns:

- 1) Omni-directional
- 2) Cardioid
- 3) Hyper-cardioid
- 4) Figure-eight

Both microphone preamplifiers are also equipped with an output attenuation switch (C-412:-20dB; C-414:-14dB).

In addition to the F.E.T. preamplifier the units also incorporate a d.c. converter which provides the polarizing voltage for the twin-diaphragm capsules.

The microphone preamplifier may be powered via a phantom circuit directly off the input equipment's (console, tape recorder, etc.) amplifier B + supply (See page 7 for complete details on powering techniques). Separate power supplies, such as the AKG N-46E or N-6E a.c. power supplies and the B-46E d.c. battery power supply, are also available.

The powering technique of the C-412, C-414 is identical to that of the C-451E.

The C-412, C-414 are being delivered with MK-17/20 anti-shock stand adapter with 66' of cable and XLR-type connector.

technical data

SPECIFICATIONS

Frequency range

: See published curve

Frequency response

: See published curve

Sensitivity

: -42 dB (re 1 mw/10 dyne/cm²)
0.6 mv/ μ bar

Impedance

: 200 ohm \pm 15%

Min. recommended load

Impedance

: 500 ohm

Equivalent noise level

: 21 dB (Din 45405 RMS)

Max. SPL

: 121 dB SPL ... 220 μ bar
0.5% distortion at 1000 Hz

Directional characteristics

: C-412 = Omni, cardioid, figure-eight
C-414 = Omni, cardioid, hyper-cardioid,
figure-eight

Output Attenuator

: C-412 = -20 dB
C-414 = -14 dB

Capsule capacity

: 2 x 100 pF

Supply voltage

: 7.5 to 60 V

Current consumption

: <5.5 mA

Temperature range

: -5° to +160° F

Humidity

: 85% ϕ /+80° F

Weight 3 lbs. 14 oz. complete

ACCESSORIES

N-46E

: a.c. power supply for
two microphones

N-6E

: a.c. power supply for
six microphones

B-46E

: d.c. battery power supply
for one microphone

W-11

: Windscreen

Table and floor stands

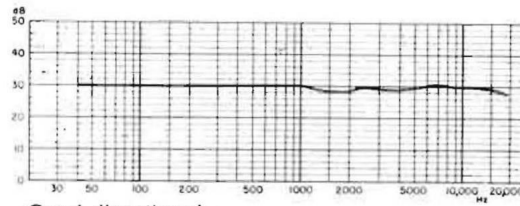
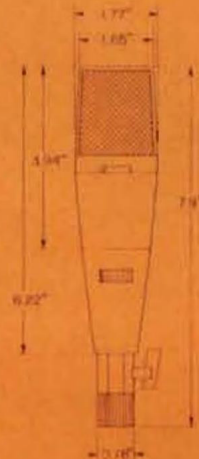

Omni-directional

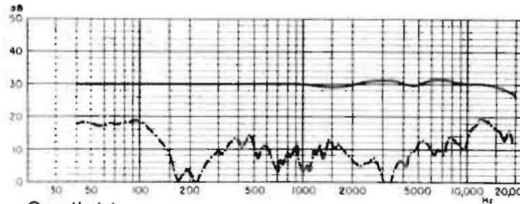
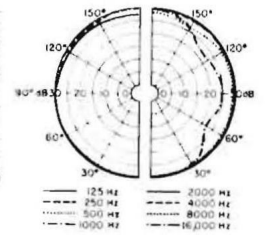

Cardioid

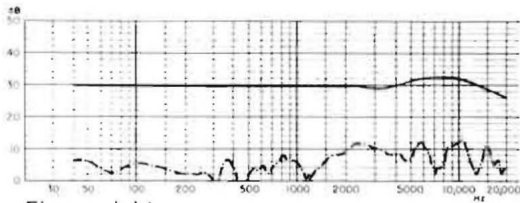
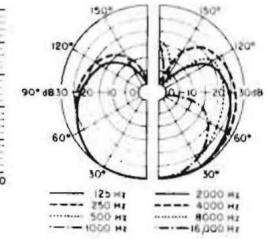
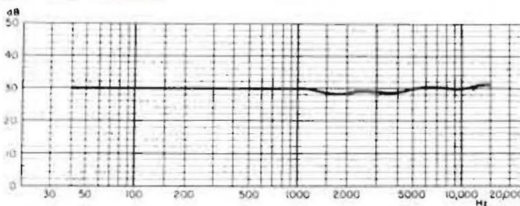
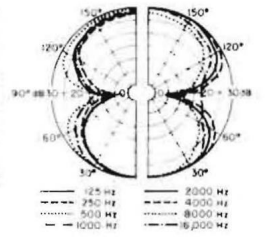
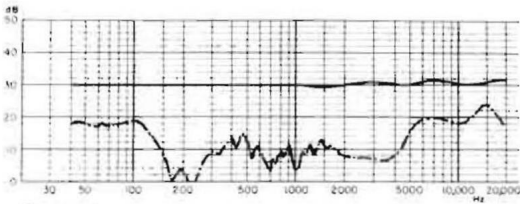
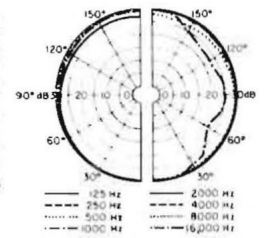

Figure-eight



Omni-directional



Cardioid

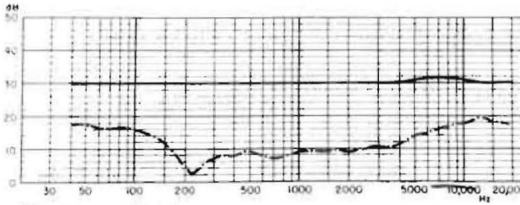
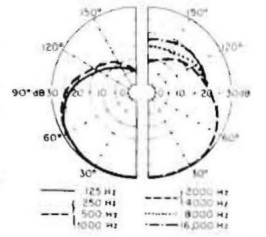

Hyper-cardioid

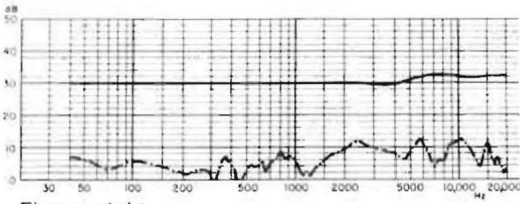
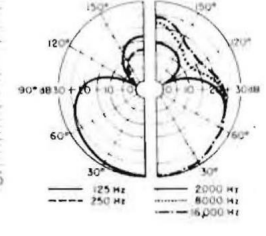
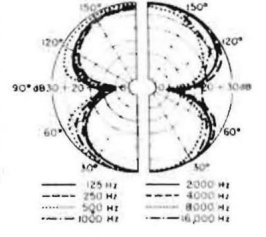

Figure-eight



AKG C-451E modular condenser microphone system



C-451E
Combination

DESCRIPTION

The AKG C-451E Condenser Microphone Modular System (CMS) represents the most unique, practical and economical approach in keeping pace with current ever-changing requirements encountered in the Recording, Broadcast, Motion Picture and Sound Reinforcement Industries.

The CMS is based on the C-451E preamplifier, using audio frequency circuitry with Field Effect Transistors. A choice of high quality, matched condenser microphone capsules, each with a different type of response characteristic and pick-up pattern may be freely interchanged on the C-451E preamplifier (see following page).

A complete selection of components and accessories, such as attenuation pads, suspensions, windscreens, etc., further illustrates the broad flexibility of the CMS.

The C-451E preamplifier may be phantom powered directly off the B+ supply of the associated (mixing console, tape recorder, etc.) equipments amplifier (for details on phantom powering technique see opposite page). Separate power supplies, such as the N-46E or N-6E a.c. power supplies and B-46E d.c. battery power supply are also available.

SPECIFICATIONS

Sensitivity	: —41 dB (1mw/10 dynes/cm ²) 1.1 mv/μbar	Current consumption	: 3-12 mA
Distortion	: 0.5% (200 μbar = 120 dB SPL)	Temperature range	: —5 to +160° F
Equivalent noise level	: 22 dB (DIN 45405) (RMS)	Humidity	: 90%/+80° F
Impedance	: 200 ohms	Dimension	: 5-7/16" X 3/4" dia.
Supply voltage	: 7.5-52v	Weight	: 4-1/2 oz.
		Connections	: XLR-3



C-451E C-452E C-451EB

Pre-amplifiers

DESCRIPTION

C-451E. Preamplifier with F.E.T. circuitry for phantom powering. For use with all capsules.

C-451EB. Preamplifier same as above but with two-step bass attenuator: at 50 Hz and 150 Hz.

C-452E. Preamplifier—Requires 48 v (+ 6 v; —8 v) phantom power supply (cannot be used with N-46E, N-6E, B-46E or AKG phantom powering; see opposite page).

powering technique

AKG C-412, C-414 and C-451E operate on voltage supplied by a phantom circuit. Standard low impedance, balanced microphone input receptacles are easily modified to simplex both operating voltage and audio output signal.

This unique powering feature offers several advantages in reduced cost and ease of condenser microphone operation.

- 1 Special, external power supplies and separate multiconductor cables formerly required with condenser microphones can be eliminated.
- 2 The B+ supply in associated recorders, audio consoles and commercial sound amplifiers can be used to directly power the C-412, C-414 and C-451E.
- 3 Dynamic, ribbon and condenser microphones can be used interchangeably on standard, low impedance, balanced microphone circuits.
- 4 Any recording, broadcast and commercial installation can be inexpensively upgraded to condenser microphone operation using existing, two-conductor microphone cables and electronics.

DIRECT AMPLIFIER POWERING

Phantom circuit use of C-412, C-414 and C-451 requires only that the microphone operating voltage be applied equally to pins #2 and #3 of the amplifier low impedance input receptacle. Pin #1 remains ground and circuit minus. The polarity of standard microphone cable wiring is not important except for the usual audio phasing requirement.

Dynamic, ribbon, and self-powered condenser microphones may be connected to the modified amplifier input without defeating the C-412, C-414 and C-451E operating voltage. Two equally effective methods of amplifier powering can be used.

- 1 Connect an amplifier B+ supply of 7.5 to 12 volts directly to the ungrounded center tap of the microphone input transformer. See DIAGRAM 1. A series dropping resistor is required for above 12 and up to 52 volts. See RESISTOR VALUE CHART 3. With a typical 24 volt B+ supply use a 4700 ohm 5% tolerance resistor for minimum current consumption.
- 2 A two-resistor, artificial center powering circuit is required when the microphone input transformer is not center-tapped, or input attenuation networks are used across the input transformer primary.

Connect a B+ supply of 7.5 to 12 volts directly to the artificial center of two 332 ohm, 1% tolerance precision resistors. Input transformer center tap is not grounded. See DIAGRAM 2 and RESISTOR VALUE CHART 3 for above 12 and up to 52 volts. Double chart resistor value. With a typical 24 volt B+ supply use two 9310 ohm precision resistors for minimum current consumption.

Any number of units may be powered by either method from a single B+ source according to the current available. Use of the largest resistor value shown (Rv max.) for various voltages in CHART 3 is recommended for minimum current consumption (j. min.). Current consumption (j. min. to j. max.) is shown in CHART 4.

When minimum current consumption is not a consideration note that an intermediate series resistor value will permit operating units from a wider range of B+ supply voltage. For example: 1000 ohms resistor with 13 to 15 volts; 1500 ohms with 14 to 18 volts; 2200 ohms with 17 to 26 volts; 3300 ohms with 20 to 46 volts; 4700 ohms with 24 to 52 volts. Double these values for both precision resistors when using the artificial center tap method.



A-52 accessory IC powering module will conveniently modify any amplifier low impedance balanced input and will phantom feed one C-412, C-414 or C-451E.

A-52 module includes the two, 1% dropping resistors required for artificial center powering as in DIAGRAM 2. The input voltage lead connects to any amplifier B+ supply from 13 to 61 volts. A Zener diode stabilizes C-412,

C-414 and C-451E powering voltage.

A-52 output leads are connected to pins #2 and #3 on the amplifier microphone input receptacle. Microphone transformer center tap is not grounded when using A-52.

One A-52 is required for each input modified to power C-412, C-414 or C-451E. Dynamic, ribbon and self-powered condenser microphones may be used interchangeably on inputs using A-52, as on all AKG phantom powering circuits.

In order to facilitate phantom powering of AKG models C-412, C-414, C-451E and F.E.T. condenser microphones requiring 48v (+6v, -8v), a 50v tap is required and the following circuit should be employed:

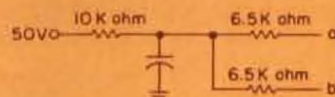

The effective series resistance is 10 K ohm plus two 6.5 K ohm resistors in parallel, for a total of 13.25 K ohm. For microphones with a load current of 3 mA the voltage drop will be 39.75v, resulting in a microphone operating voltage of 10.25v, required for the AKG C-412, C-414 and C-451E.

For microphones with a load of 0.4 mA the voltage drop will be 5.3v, resulting in a microphone voltage of 44.7v, suitable to operate F.E.T. condenser microphones requiring 48v (+6v, -8v) operating voltage.

1 Center tap connection

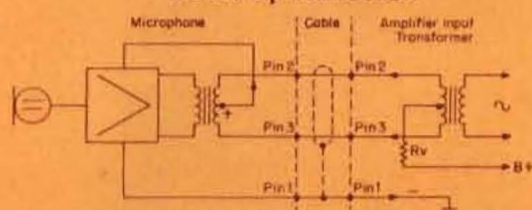

2 Artificial center tap connection

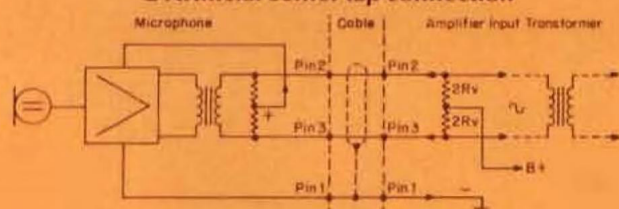

3 Resistor value chart

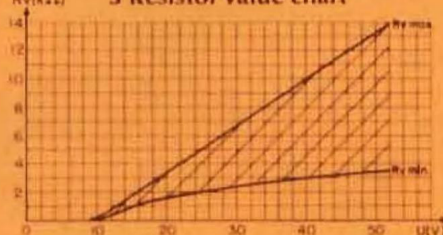

4 Current consumption chart

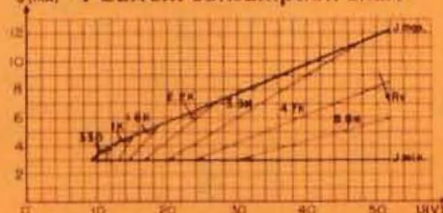

5 Multiple microphone connection; common tap

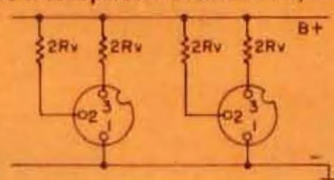

capsules for C-451E, C-451EB, C-452E preamplifiers

CK-1



AKG CK-1. Cardioid condenser microphone capsule with flat response. For all applications where a flat on-axis and linear off-axis response is required. Wide front-to-back discrimination at all frequencies.

CK-1S



AKG CK-1S. Cardioid condenser microphone capsule with rising response. Applicable when recording close to the source is impossible or when added high frequency presence is desired.

CK-2



AKG CK-2. Omni-directional condenser microphone capsule. For use in recording when non-directional pattern is desirable. Suitable as measuring device.

CK-5



AKG CK-5. Cardioid condenser microphone capsule internally suspended and with integral windscreen. For use as hand-held microphone by performers or in applications where shock suspension and floor-born sound isolation is required.

CK-6



AKG CK-6. Variable pattern condenser microphone capsule. Built-in switch permits selection of either omni-directional, cardioid or figure-eight polar patterns.

CK-8



AKG CK-8. Short interference tube condenser microphone attachment with built-in capsule. For use wherever higher directivity and off-axis rejection over normal cardioid pattern is required.

CK-9



AKG CK-9. Interference tube (shot-gun) condenser microphone attachment with built-in capsule. Offers high directivity and off-axis rejection at all frequencies. For use in motion picture, TV and recording.

AKG's range of advanced, miniature condenser microphone capsules are based on a gold-vapored ceramic electrode with a permanently fixed metallic diaphragm. Both materials have the same expansion co-efficient, making the capsules impervious to a wide range of temperature and humidity fluctuations and they are free of deterioration and hysteresis. The ceramic electrode is provided with an insulating coating, preventing short circuit of electrode and diaphragm.

Sensitivity (w/C-451E): — 40 dB (1mw/10 dynes/cm²)
 .95 mv/μbar at 200 ohms
Temperature range: — 5° to +160° F
Humidity: 90%/o/+80° F
Dimension: 14/16" lg X 3/4" dia.
Weight: 1 oz.

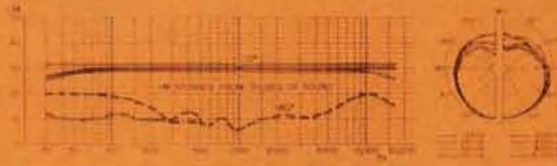

Sensitivity (w/C-451E): — 40 dB (1mw/10 dynes/cm²)
 .95 mv/μbar at 200 ohms
Temperature range: — 5° to +160° F
Humidity: 90%/o/+80° F
Dimension: 14/16" lg X 3/4" dia.
Weight: 1 oz.

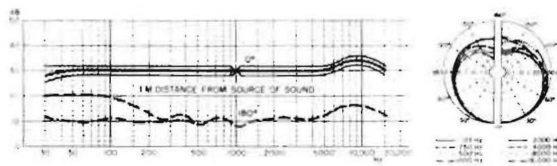

Sensitivity (w/C-451E): — 41 dB (1mw/10 dynes/cm²)
 .8 mv/μbar at 200 ohms
Temperature range: — 5° to +160° F
Humidity: 90%/o/+80° F
Dimension: 14/16" lg X 3/4" dia.
Weight: 1 oz.

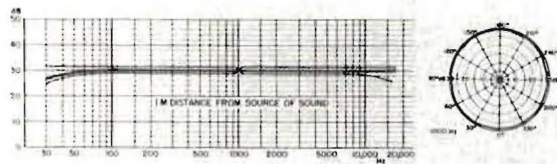

Sensitivity (w/C-451E): — 40 dB (1mw/10 dynes/cm²)
 .95 mv/μbar at 200 ohms
Temperature range: — 5° to +160° F
Humidity: 90%/o/+80° F
Dimension: 14/16" lg X 3/4" dia.
Weight: 3 oz.

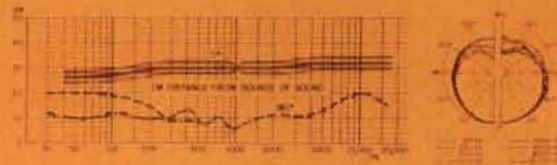

Sensitivity (w/C-451E): — 40 dB (1mw/10 dynes/cm²)
 .95 mv/μbar at 200 ohms
Temperature range: — 5° to +160° F
Humidity: 90%/o/+80° F
Dimension: 2-1/2" lg X 1-3/4" dia.
Weight: 3 oz.

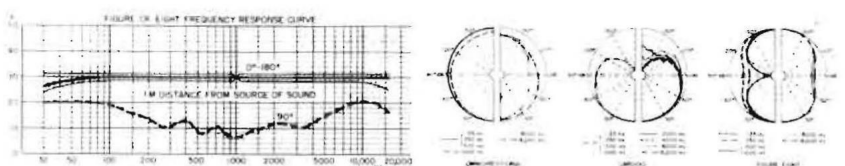

Sensitivity (w/C-451E): — 41 dB (1mw/10 dynes/cm²)
 0.8 mv/μbar at 200 ohms
Temperature range: — 5° to +160° F
Humidity: 90%/o/+80° F
Dimension: 8-1/4" lg X 3/4" dia.
Weight: 4 oz.

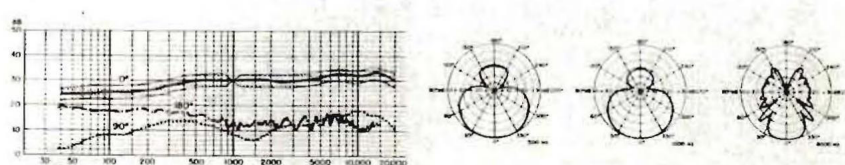

Sensitivity (w/C-451E): — 41 dB (1mw/10 dynes/cm²)
 0.8 mv/μbar at 200 ohms
Temperature range: — 5° to +160° F
Humidity: 90%/o/+80° F
Dimension: 15/16" dia X 26-1/4" lg.,
 including preamp.
Weight: 8 oz.

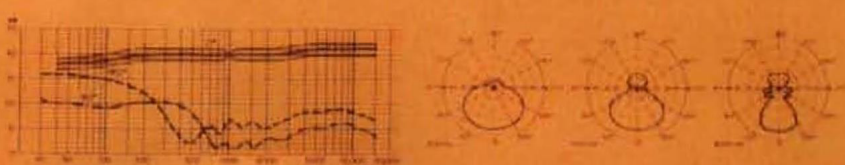

power supplies for AKG C-412, C-414 and C-451E

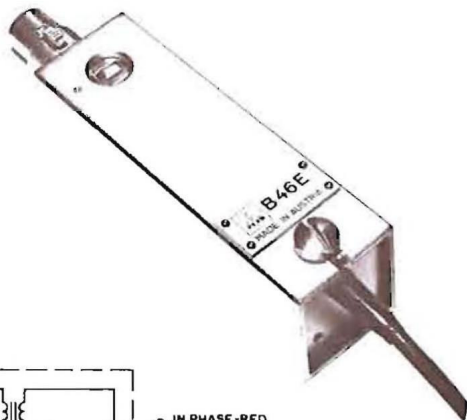

B-46E

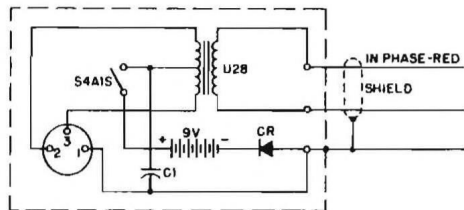

DESCRIPTION

B-46E battery power supply with built-in on-off switch. Operates on regular 9 volt battery. Operating time may range from 40 hours with a standard 9v battery and up to 220 hours with long life types. XLR-3 type input receptacle; non-detachable cable with stripped end on output side.



N-46E

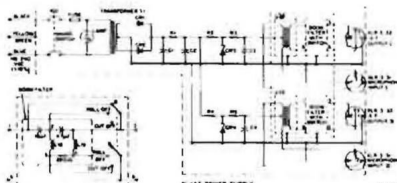
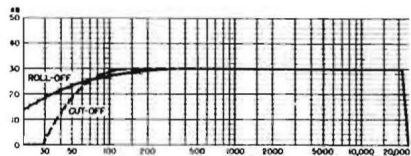

DESCRIPTION

N-46E is a dual a.c. power supply for two F.E.T. condenser microphones. It incorporates a bass roll-off/bass cut switch for each microphone. Delivered with adapter trim plate for mounting in standard 19" rack panel.

SPECIFICATIONS

Input voltage : 110 v/220v a.c.

Output voltage : 12 v d.c.

Operating voltage : 10.5 v

Connections: Input XLR-3-31: 1 = Shield
2 + 3 = + 12 v

Output XLR-3-32: 1 = Shield
2 + 3 = + A.F.

a.c. supply yellow/green: Shield
black: a.c. **blue:** a.c.

DESCRIPTION

N-6E will operate 6 F.E.T. condenser microphones. Comes pre-wired for 2 microphones and may be expanded to operate up to 6 microphones (See description on page 7: Multiple microphone connections; common tap). Suitable for standard 19" rack mounting.

SPECIFICATIONS

Input voltage : 110 volts a.c.

Output voltage : 12 volts d.c.

Operating voltage : 10.5 v

Connections : Same as N-46E

Dimensions : 19" wide, 3 1/2" high, 6" dia.

Weight : 5 lbs.

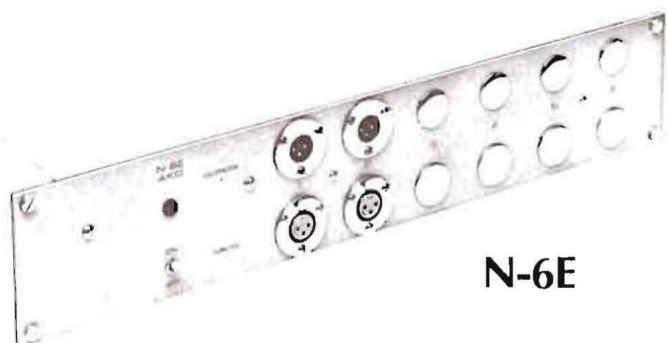

N-6E

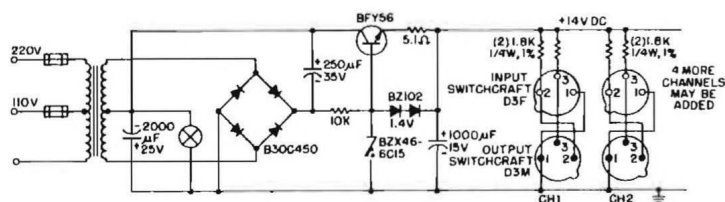

components and accessories for C-451E



PADS



A-50/10
10dB pad

A-50/20
20dB pad

Number of A-50/10	dB of attenuation	Number of A-50/20	dB of attenuation
1	-10.7 dB	1	-19.3 dB
2	-15. dB	2	-24.9 dB
3	-18.2 dB	3	-28.2 dB
4	-20.7 dB	4	-31.7



SWIVEL

A-51

For insertion between capsule and preamplifier; permits angling of capsule by ± 90 .



H-24



H-15



H-10



H-9

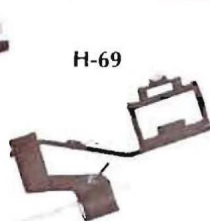

H-69



H-70

SUSPENSIONS

Rubber Grip Handle



H-7

SA-70/3



W-3



W-17

WINDSCREENS



W-19



W-18

STAND ADAPTERS



SA-15/1



SA-18/1
SA-18/3

FLEXIBLE SHAFT



MSH-58E
MSH-58E-2

TABLE STANDS



ST-4A

ST-41

ST-43



ST-305

AKG Condenser Microphone Shot Gun Systems:



Fitted
Carrying Case

C-451/CK-1/CK-9 System, consisting of:

C-451EB Preamplifier
CK-1 Cardioid capsule
W-3 windscreen for above
SA-15/1 stand adapter
CK-9 Shot gun tube
W-19 windscreen for above
SA-18/3 stand adapter
H-69 Boom suspension
H-7 pistol grip
B-46E Battery supply
MC-20 cable
Fitted carrying case

C-451/CK-9 System, consisting of:

C-451EB Preamplifier
CK-9 Shot gun tube
W-19 windscreen for above
SA-70/3 stand adapter
H-7 pistol grip
B-46E Battery supply
MC-20 cable
Fitted carrying case

EXTENSION TUBES

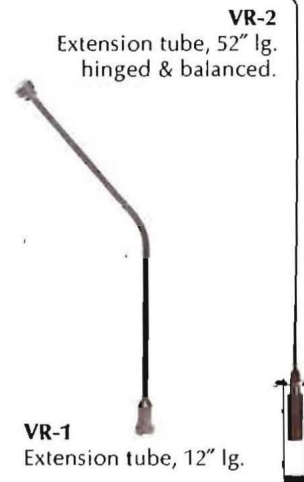

VR-2

Extension tube, 52" lg.
hinged & balanced.

VR-1

Extension tube, 12" lg.

professional two-way cardioid dynamic microphones



D-202E

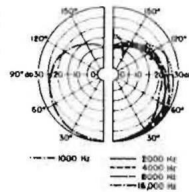
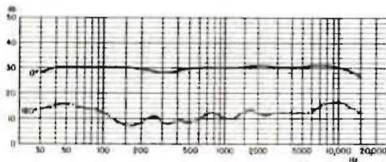

DESCRIPTION

The D-202E is the original cardioid dynamic microphone based on the two-way concept, described on the opposite page. Its frequency response is virtually flat and the 90° off-axis response approximately 4-6 dB lower in output, is parallel to the on-axis response, resulting in superb linear acceptance. The front-to-back discrimination is 20 dB over the entire range and offers maximum feedback cancellation. The unit is provided with two-step low frequency attenuation (—7 & —20 dB at 50 Hz). The D-202E is equipped with AKG's unique sintered bronze cap which functions as a windscreen and pop filter, is waterproof and protects the microphone system from iron particles and dust.

SPECIFICATIONS

Sensitivity: —53 dB (re 1 mw/10 dynes/cm²)

Impedance: 200 ohms

Max. Sound Pressure level: 0.5% = 124 dB SPL (300 μbar)

Dimension: 8 1/2" long, 2 1/2" dia. at largest point

Weight: 10 oz.

ACCESSORIES

SA-16/1 Stand adapter

W-7 Windscreen

W-9A Windscreen, rear

H-70/SA-70/9 Suspension

MSH-58 Flexible shaft

AKG Stands



D-224E

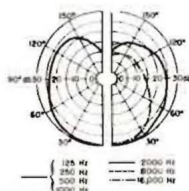
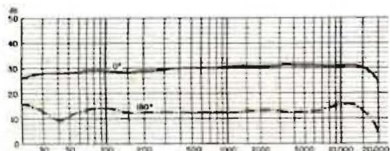

DESCRIPTION

The D-224E is the studio version of the two-way cardioid dynamic microphones. In addition to all the features inherent in the two-way technique, the D-224E's noteworthy characteristic is its exceptionally wide and smooth frequency response, normally expected only from condenser microphones. Its linear acceptance, up to 90° off-axis, is of particular importance in recording applications since signals reaching the microphone off-axis will not be discriminated against. The low frequency response may be attenuated by an electrical, two position (—7 and —12 dB at 50 Hz) bass roll-off switch.

SPECIFICATIONS

Sensitivity: —55 dB (re 1 mw/10 dynes/cm²)

Impedance: 200 ohms

Max. Sound Pressure level: 0.5% = 124 dB SPL (300 μbar)

Dimension: 7 3/4" lg, 15/16" dia.

Weight: 9 1/2 oz.

ACCESSORIES

SA-18/3 Stand adapter

W-2 Windscreen

H-70/SA-70/3 Suspension

MSH-58E Flexible Shaft

AKG Stands

two-way concept

This AKG series of cardioid dynamic microphones is based on a new revolutionary concept — the two-way microphone system*, representing the most significant advancement in microphone development and audio engineering.

The communication field is growing at a rapid pace. Primarily the electro-acoustical engineer is concerned with transmitting a message, in our case a sound event, without deterioration and as faithfully as possible, including all its tangible and irrational components.

Usually acoustic message transmission begins with a microphone and ends with a loudspeaker. It is interesting to note that development engineers in the U.S. have concentrated primarily on loudspeaker improvement, whereas the microphone received greater attention in Europe. However, the first basic work on dynamic directional microphones was conducted in the U.S. and reported in 1933.

Because of its convenient and reliable operating characteristics, the dynamic microphone has found widespread applications in studio use — particularly in field work and public address installations. Compared to the condenser microphone its disadvantages have until now been considered to include its narrower frequency range, some irregularity in frequency response, lower sensitivity, susceptibility to magnetic stray fields and — especially in the case of directional microphones — directional characteristics that were not completely satisfactory and rather frequency-dependent.

Assisted by computer research findings it was found that it is not possible, even with complex acoustic networks, to significantly and concurrently increase frequency range, frequency response and uniform front-to-back discrimination of a cardioid dynamic microphone.

To aid in this research project, AKG's Research and Engineering Department developed an Analog-Computer (Simulator), unique in this field. The Simulator is capable of electronically imitating all acoustical-physical relations of electro-acoustical transducers.

A two-way cardioid dynamic microphone system evolved from this research. In a two-way microphone system, the total response range has been subdivided between a high frequency and a low frequency transducer, each of which is optimally adjusted to its specific range (similar to a two-way speaker system). The two systems are connected by means of a cross-over network with the cross-over frequency at 500 Hz.

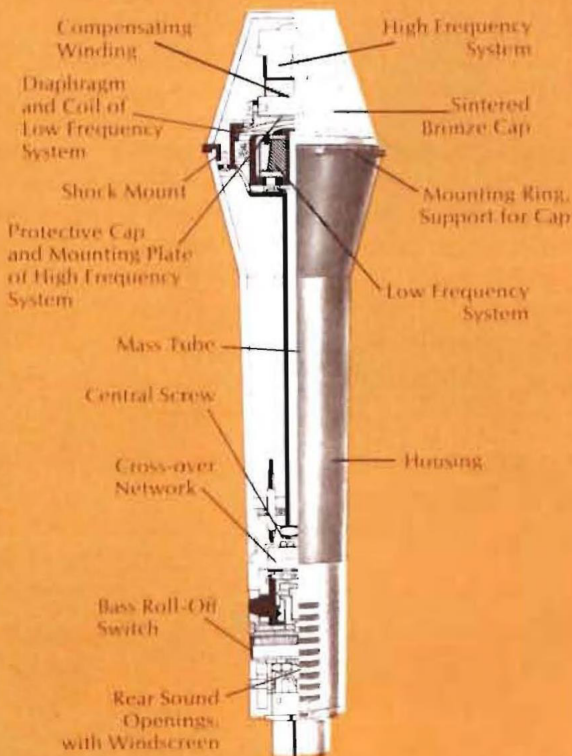

This arrangement is depicted in the cross-section drawing shown at bottom of left column. The high frequency system is mounted on the protective cap of the low frequency system. The low frequency system is connected to a mass tube with apertures at the rear of the microphone. For maximum reduction of wind sensitivity at the rear sound openings, the aperture of the mass tube does not connect directly with the open air but instead leads to a chamber which communicates with the sound field via slotted openings covered with damping material.

The high frequency system is shock-mounted to reduce handling sensitivity and is provided with a compensating winding to eliminate the effects of magnetic stray fields.

The cross-over network is housed in the lower portion of the microphone. In the case of the D-2021 and D-224, the output circuit of the microphone contains an electrical bass attenuator to permit a reduction in low frequencies.

This unique arrangement achieves a number of previously unobtainable performance characteristics for cardioid dynamic microphones:

Flat frequency response over the entire audible range. The low as well as the high frequency system is optimally adjusted to its specific frequency range and the cross-over point, at 500 Hz, is unnoticeable.

Linear off-axis response. Sound reaching the microphone 90° off-axis is reproduced naturally. No frequency discriminating characteristics, which commonly arise from dynamic microphones, are audible.

Uniform front-to-back discrimination. The two-way system main-

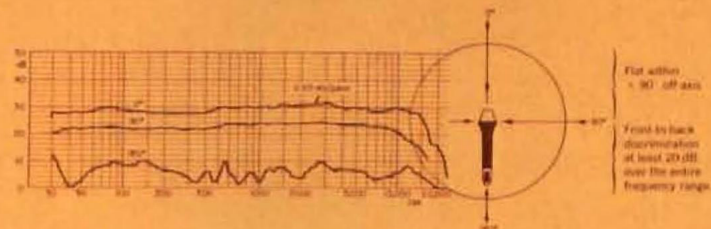

tains a front-to-back discrimination of at least 20 dB over its entire range, even in the critical low frequency and upper mid-range area. The polar pattern shows the directional characteristics of the microphone at 125 Hz, 1,000 Hz and 8,000 Hz as recorded with a polaroscope. For better graphic clarity, a different sound level was used for each pattern.

POLAR DIAGRAM

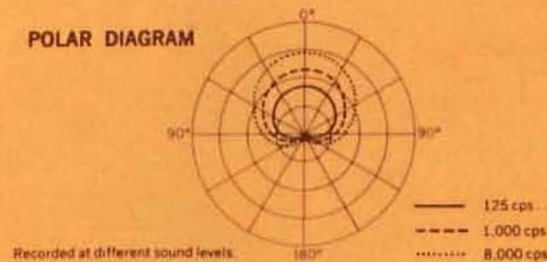

Proximity effect. A complete absence of proximity effect—the rise of low frequency response when microphone is used in close-up applications—is a distinguishing characteristic of the two-way system compared to other directional microphones.

These features offer several advantages in practical applications: The flat frequency response allows the most natural and faithful pick-up of the sound event for transmission during a recording application. In public address installations it permits control of feedback at any frequency.

The linear 90° off-axis response is of particular importance in recording applications whenever a number of microphones are used, since frequencies reaching the microphone ±90° off-axis (leakage from left or right of microphone, other instruments, etc.) are reproduced faithfully without discriminating characteristics. The same also applies to public address installations where a speaker may move to the left or right (off-axis) of the microphone.

Uniform front-to-back discrimination is of prime importance in public address installations since it virtually eliminates feedback and offers almost complete freedom in microphone and speaker placement. For instance, it was found that a gain of approximately 6 db could be achieved in a majority of sound systems. The exceptional front-to-back discrimination of this exclusive design offers better than average separation in recording applications.

*U.S. Patent #3,204,031

professional dynamic microphones

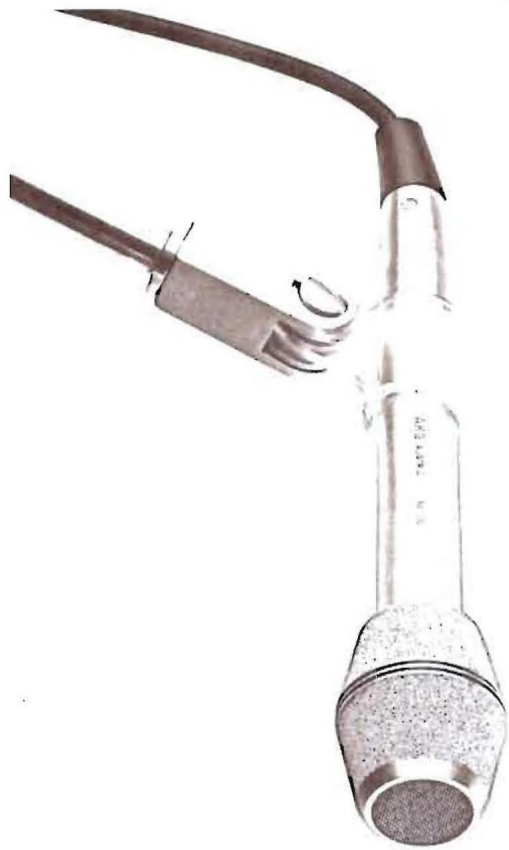

D-124E

DESCRIPTION

The D-124E is a studio recording microphone based on a small transducer of superb performance characteristics. Its small dimension and attractive, unobtrusive design fulfill the requirements of TV Broadcast and Public Address Systems engineers as well as those of professional performers.

The acoustical properties of the D-124E exceed those normally expected of cardioid dynamic microphones and it excels particularly in smoothness of response over a wide range, and a well maintained directional pattern at all frequencies. The unit is equipped with a recessed 10 dB bass attenuation switch to compensate for low frequency resonance or proximity effects.



D-900E

DESCRIPTION

In designing a highly directive (shot-gun) dynamic microphone, AKG combined the gradient and interference principles. The results, incorporated in the D-900E, are smooth on-axis response and an off-axis rejection which is maintained over the entire range, including the critical low frequencies. The D-900E is equipped with a two-position bass roll-off switch (-7 and -20 dB at 50 Hz) which permits use of the microphone in acoustically unfavorable environments and also eliminates the effects of low frequency boom rumble or wind noise.

The D-900E is slim in appearance and of light weight.

technical data

SPECIFICATIONS

Sensitivity:
-55 dB (re 1 mw/10 dynes/cm²)

Impedance:
200 ohms

Dimension:
5" x 1 6/16"

Weight:
6 oz.

ACCESSORIES

W-21
Windscreen (replacement)

H-24
Suspension

MSH-58E
Flexible Shaft

Sa-25
Stand adapter (replacement)

AKG Stands

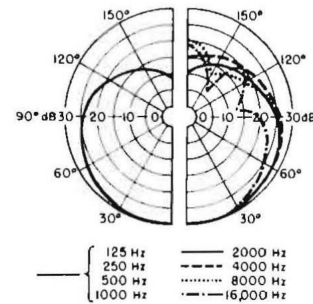
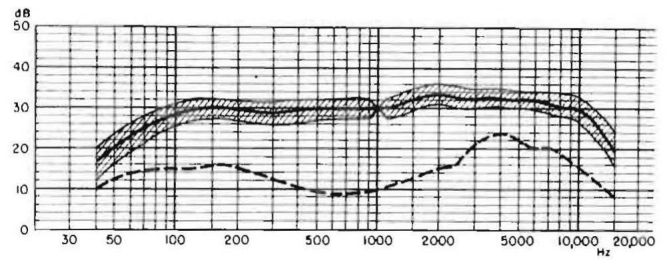

SPECIFICATIONS

Sensitivity:
-50 dB (re 1 mw/10 dynes/cm²)

Impedance:
200 ohms

Dimension:
2 6 1/8" x 1 1/4" dia.

Weight:
17 oz.

ACCESSORIES

W-19
Windscreen

W-9A
Windscreen, rear

SA-16/1
Stand adapter

H-68
Boom suspension, complete

D-900E Combination system in fitted carrying case.
System consists of:
D-900E
H-68 Suspension
H-7 Pistol grip
W-19 Windscreen

H-70
Suspension (for use with SA-70/9)

SA-70/9
Stand adapter with arm (for H-7)

H-7
Pistol grip

SA-16/1 Stand adapter
MC-20 cable
Fitted carrying case

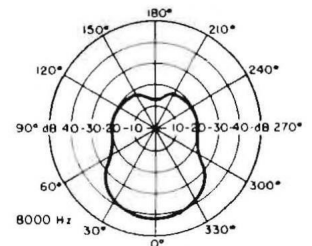
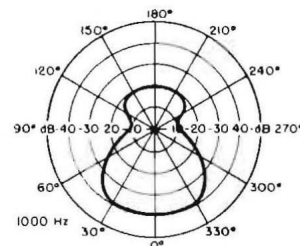
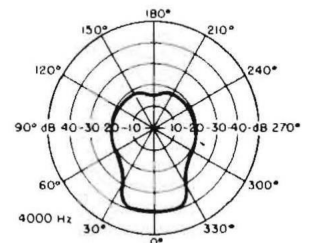
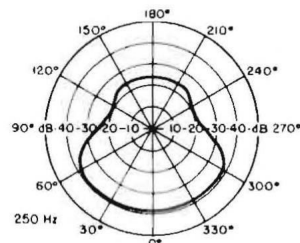
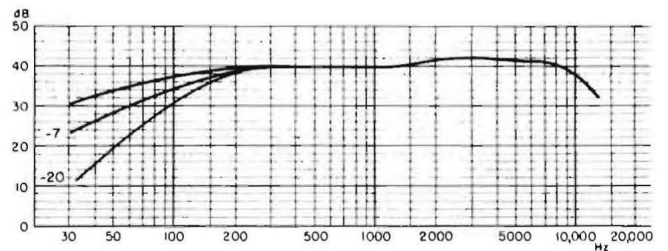

professional dynamic microphones



D-58E

D-558



DESCRIPTION

Both microphones are based on the differential acoustic pressure principle and are ideally suited for application in areas with high ambient noise levels and to effectively cancel feedback. The optimum range of pick-up is 5" from the source of sound and the frequency response is tailored for maximum speech intelligibility.

Both units can be employed indoors as well as outdoors since they are equipped with an integral windscreen, which also protects the microphones from iron particles and dust.

The D-58E terminates into a built-in XLR-3 type connector.

The D-558B is permanently attached to a 87/8" long flexible shaft.



D-110

DESCRIPTION

Dual housing and suspension mounting of the microphone system eliminate handling, clothing and cable rubbing noise with the AKG D-110 lavalier microphone. Miniaturized and styled for inconspicuous use in broadcast, motion picture and sound reinforcement, the D-110 response characteristics are specially contoured to compensate for the resonance of the human chest cavity.

The D-110 is delivered with 30' of field replaceable, lightweight, flexible and durable cable, lavalier clip and nylon neck cord.

technical data

SPECIFICATIONS

Sensitivity:

— 54 dB (re 1 mw/10 dynes/cm²)

Impedance:

200 ohms

Average discrimination:

— 22 dB at 1,000 Hz, — 37 dB
at low frequencies, — 15 dB at high frequencies

Dimension:

D-58E = 1⁵/₈" lg x 13/16 dia.

D-558B = 12-3/16" lg x 7/8" dia.

Weight:

D-58E = 1.1 oz.

D-558E = 9 oz.

ACCESSORIES

Both

W-3 Windscreen

D-58E

MSH-58E 8" lg flexible shaft

MSH-58 E2 20" lg flexible shaft

D-558E

ST-4A Table stand

ST-4I Table stand with one push button

ST-43 Table stand with three push buttons

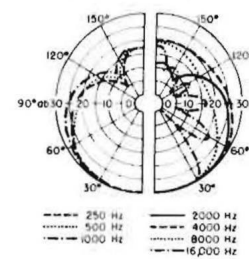
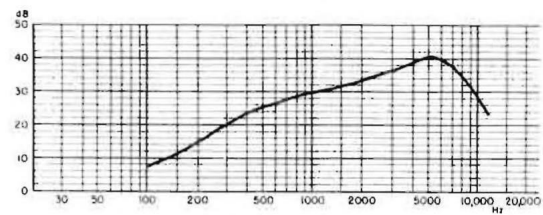
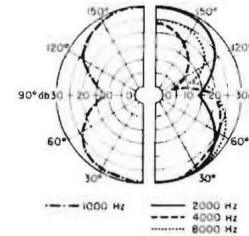
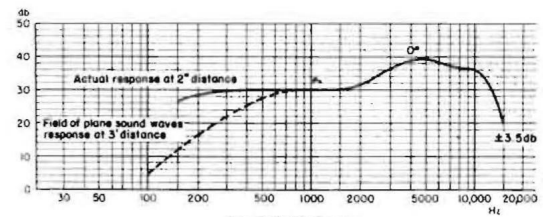

SPECIFICATIONS

Sensitivity:

— 56 dB (re 1 mw/10 dynes/cm²)

Impedance:

200 ohms

Dimension:

3-3/16" lg x 23/32" dia.

Weight:

2.75 oz.

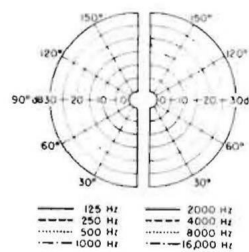
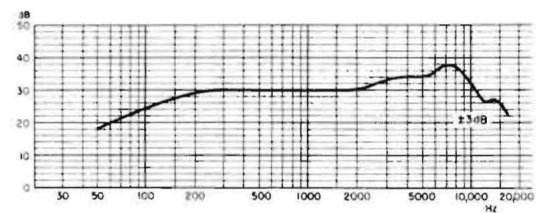

omni-directional dynamic microphones



D-109

DESCRIPTION

Small in size, inconspicuous in use—yet its small capsule surpasses the sensitivity of most professional dynamic microphones. Sound is reproduced clearly and naturally. A sliding shield boosts frequency response for more “presence.”

The D-109 is supplied with 30 feet of non-detachable lightweight cable, lavalier clip with clasp and nylon neck cord.



D-160E

DESCRIPTION

The D-160E features a removable, rugged wire mesh windscreen which, when mounted, locks securely to the microphone body. Without the windscreen the unit has linear, full range response. With the windscreen attached the response range has a 4 to 5 dB boost between 3,000-12,000 Hz for use in acoustically “dull” environments and for greater working distance. This superb, professional omni-directional dynamic microphone will find application in studio recording, remote pick-up, hand held use by performers and in interviews.



D-510

DESCRIPTION

The D-510 is an omni-directional microphone with linear response and designed to reproduce clear, intelligible speech without harshness and popping. The polar pattern is maintained uniformly over a range of 360°. The D-510 is equipped with an 8⁷/₈” long flexible shaft and is suitable for mounting directly on any vertical or horizontal surface.

Ideally suited for industrial applications, paging, interviews and broadcasting.

technical data

SPECIFICATIONS

Sensitivity:

-56 dB (re 1 mw/10 dynes/cm²)

Impedance:

200 ohms

Dimension:

2³/₄" lg x 5/₈" dia.

Weight:

1¹/₂ oz.

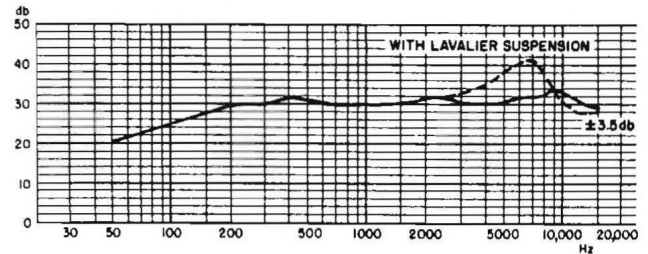

SPECIFICATIONS

Sensitivity: -55 dB (re 1 mw/10 dynes/cm²)

Impedance: 200 ohms

Dimension: 5⁷/₈" lg x 1³/₈" dia.

Weight: 7.5 oz.

ACCESSORIES

W-8 Windscreen, foam

H-24 Suspension

SA-11/1 Stand Adapter

MSH-58E Flexible Shaft

AKG Stands

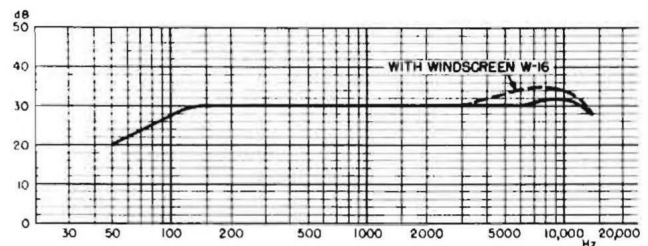

SPECIFICATIONS

Sensitivity:

-56 dB (re 1 mw/10 dynes/cm²)

Impedance:

200 ohm

Dimension:

12-3/16" lg x 7/₈" dia.

Weight:

9 oz.

ACCESSORIES

W-3

Windscreen

ST-4A

Table stand, weighted

ST-41

Same as above but with one push button.

ST-43

With three push buttons

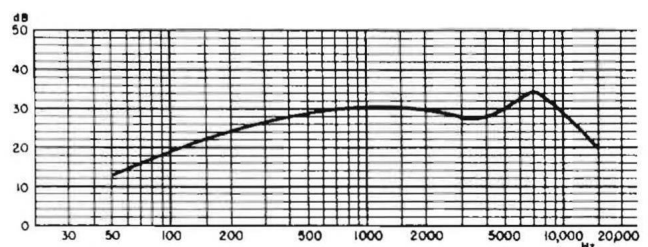

cardioid dynamic microphones

D-190E/D-190ES

D-190ES with built-in on-off switch



DESCRIPTION

AKG D-190E Series. These microphones are based on a cardioid dynamic transducer which distinguishes itself by a smooth, wide range response with exceptional front-to-back discrimination at all frequencies. These features ensure clear and effortless sound transmission without feedback, as well as exceptionally good recordings even under acoustically unfavorable conditions. An integral sintered bronze cap eliminates the disturbing effects of breath noise and air turbulence and also protects the microphone system from dust, iron particles and moisture.

D-190TS is delivered with MC-20TS cable assembly for High impedance operation with on-off switch.

D-590



The D-590 is similar in performance characteristics to the D-190 except that the low end of the response range has been attenuated to defeat low frequency oscillation and table-born noise when mounted directly on surfaces. The unit comes equipped with a 9³/₄" long, non-detachable, flexible shaft plus mounting hardware and cable.

D-200E



Based on the revolutionary "Two-Way" concept (See page 13) this is truly a superb cardioid dynamic microphone. Objective, faithful reproduction of sound, without off-axis discoloration, is obtained with the D-200E. In public address systems it permits control of feedback and offers almost complete freedom of microphone and speaker placement. Smooth, full range response, linear off-axis acceptance and total lack of proximity effect are the main characteristics of the D-200.

D-200TS is delivered with MC-20TS cable assembly for High impedance operations with on-off switch.

D-707E



The 707E is a multi-purpose quality microphone with professional performance characteristics and is suitable for recordings and public address applications. It is particularly capable of handling high sound pressure levels without overload or distortion. It features an integral windscreen, rugged construction and is resistant to rough handling.

D-707TS is delivered with MC-20TS cable assembly for High impedance operation with on-off switch.

D-1000E



The D-1000E has been developed for the performing artist, record, broadcast and public address system applications. It features a mode selection switch to shape the microphones response characteristics.

B=Bass: Emphasizes smooth low frequency response.

M=Medium: Attenuated bass; emphasizes middles and highs for greater working distance.

S=Sharp: Added upper mid-range brilliance and presence.

D-1000TS is being delivered with MC-20TS cable assembly for High impedance operation with on-off switch.

technical data

SPECIFICATIONS

Sensitivity: - 53 dB (re 1 mw/10 dynes/cm²)

Impedance: D-190E, D-190ES = 200 ohm

D-190TS = High Z

Dimensions: 6¹/₄" lg x 1¹/₂" dia.

Weight: 6 oz.

ACCESSORIES

W-8 Windscreen

H-24 Suspension

MSH-58E Flexible Shaft

SA-11/1 Stand Adapter (Replacement)

AKG Stands

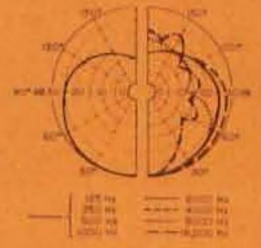
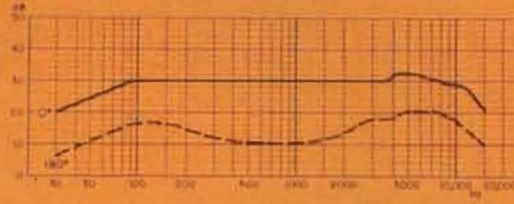

Sensitivity: - 52 dB (re 1 mw/10 dynes/cm²)

Impedance: 200 ohms

Dimensions: 11¹/₈" lg x 1⁵/₈" dia.

Weight: 9 oz.

W-8 Windscreen

ST-4A Table stand, weighted

ST-41 Same as above but with one push button.

ST-43 With three push buttons.

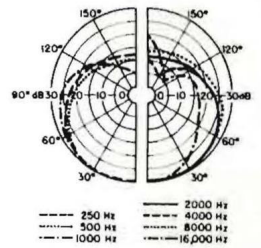
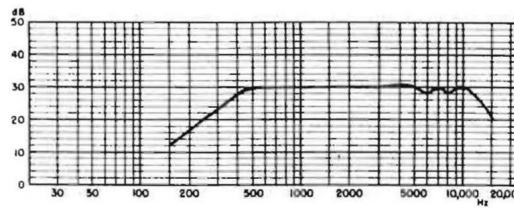

Sensitivity: - 55 dB (re 1 mw/10 dynes/cm²)

Impedance: D-200E = 200 ohm

D-200TS = High Z

Dimensions: 7-5/16" lg x 1⁵/₈" dia.

W-4 Windscreen

MSH-58E Flexible Shaft

SA-20/1 Stand Adapter (Replacement)

AKG Stands

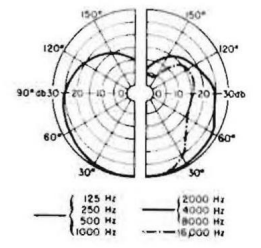
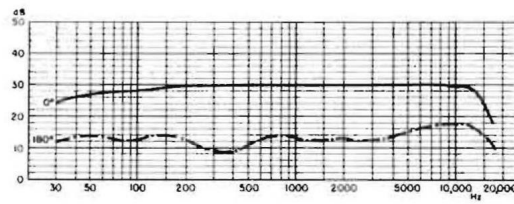

Sensitivity: - 52 dB (re mw/10 dynes/cm²)

Impedance: D-707E = 200 ohms

D-707TS = Hi Z

Dimension: 6" lg x 7/16" dia.

Weight: 5.7 oz.

H-24 Suspension

MSH-58E Flexible Shaft

SA-11/1 Stand adapter (Replacement)

AKG Stands

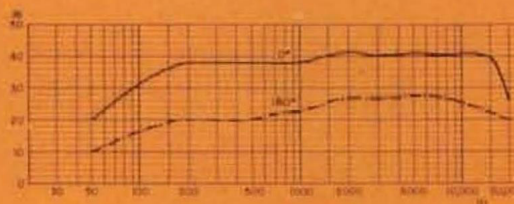

Sensitivity: - 53 dB (re 1 mw/10 dynes/cm²)

Impedance: D-1000E = 200 ohm

D-1000TS = High Z

Dimension: 6" lg x 1-7/16" dia.

Weight: 9¹/₂ oz.

MSH-58E Flexible Shaft

W-4 Windscreen

SA-12/1 Stand Adapter (Replacement)

AKG Stands

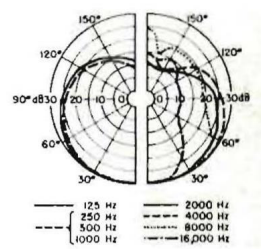
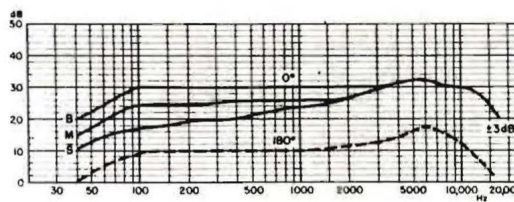

dynamic headphones and boom sets



K-2000

K-16TV

DESCRIPTION

Both are ultra lightweight headsets designed primarily for monitoring purposes. The K-16 is a dual headset while the K-2000 is a single headphone driver. Designed for use at home to listen to TV and Radio Broadcast without disturbing others, in schools, hospitals and various industrial application.



K-100

A stereo dynamic headphone combining AKG's traditional quality in high fidelity sound transmission with light-weight wearing comfort at an economic price. AKG's headphones are marked by high efficiency and permit universal impedance matching from 4 through 10,000 ohms.



K-150

Engineered to meet the requirements of the most critical music listener, the K-150 delivers extended bass, smooth mid-range and crisp uniform high end response while dispelling the theory that a truly fine headphone must be costly. The matchless K-150 stereo dynamic headphone is an expression of AKG's precision, craftsmanship and engineering excellence.



K-180

The most innovative development since the introduction of stereo dynamic headphones. By turning adjustment knobs the acoustic driver may be turned back and forth, thereby varying the auditory volume between ear entrance and driver. The driver in close proximity to the ear entrance will result in brilliant, presence sound. In the rearmost position the sound will be diffused, similar to concert hall sound characteristics. A truly unique experience.



K-108

An economically priced boom set combining the performance of the AKG K-100 headphone and D-58/D-558 noise-cancelling differential microphone. Designed for schools and industrial applications, the K-108 headphones are connected in series, with a low impedance dynamic microphone, wired unbalanced.



K-158

K-158/T-301

Both units are professional dynamic boom sets designed for use in Television and Radio Broadcast as well as various industrial applications. They are two-channel units, with separate leads to each headphone driver plus low impedance dynamic noise-cancelling microphone, connected balanced. The K-158/T-301 is equipped with transistor preamplifier for high (telephone) level output.

technical data

microphone accessories

SPECIFICATIONS

Frequency range:

60 to 12,000 Hz

Impedance:

600 ohms each driver

Distortion:

Less than 1% at 100 dB SPL

Weight: K-16 TV = 5 oz. • K-2000 = 2 oz.

Frequency range:

20-20,000 Hz

Normal power requirement:

1 mw for 112 dB SPL

Impedance:

600 ohms per channel

Distortion:

under 1% at 125 dB SPL

Weight: 13 oz.

Frequency range:

20-20,000 Hz

Normal power requirements:

1 mw for 112 dB SPL

Impedance:

600 ohms each system

Distortion:

under 1% at 125 dB SPL

Weight: 9 oz.

Frequency range:

16-20,000 Hz

Normal power requirements:

1 mw for 112 dB SPL

Impedance:

600 ohms each system

Distortion:

Less than 1% at 125 dB SPL

Weight: 21 oz.

Headphones:

See K-100

Microphones:

See D-58E/D-558B

Weight: 15 oz.

Headphones:

see K-150

Microphone:

see D-58E/D-558B

K-158/T-301 w/amplifier:

Vdc: 12 v • Ib: 25 mA • gain: 60 dB

Weight: 15 oz.

WINDSCREENS



SUSPENSIONS



TABLE STANDS

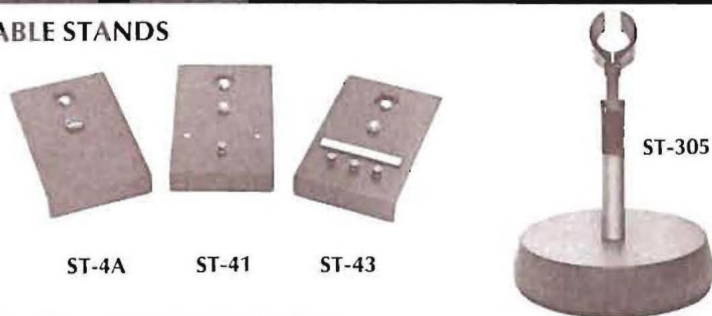

STAND ADAPTERS



FLEXIBLE SHAFT



CABLES



For information and prices on complete line of KM series MICROPHONE FLOOR STANDS and ACCESSORIES consult separate specifications and price sheet.



AVAILABLE THROUGH—



Detailed specifications on all items covered in this brochure are available upon request.

SCANS von archive.org