

ACCESSORIES FOR

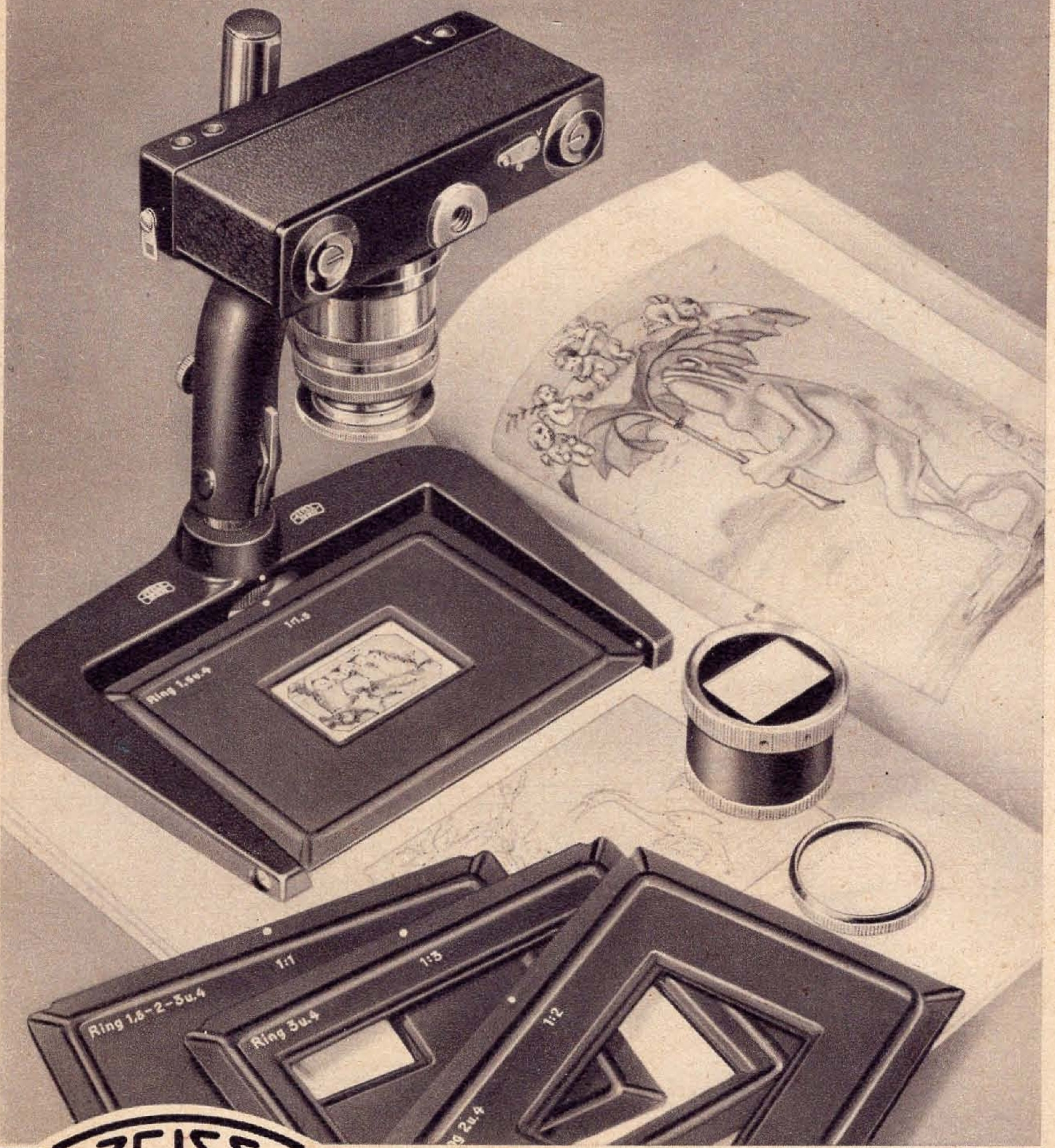

CONTAX PHOTOGRAPHY

ACCESSORIES
FOR CONTAX
PHOTOGRAPHY

ZEISS IKON A G DRESDEN

C 551 E

CONTENTS

PART I:	Close-up Subjects, Copies and Photo- micro Work	
	Supplementary Lenses	Page 6
	Optical Near Focussing Equipment	8
	Large Copying Stand and X-ray Plate	
	Copying Apparatus	10
	Special Copying Stand	16
	Photo-micro Apparatus	18
	Plate Adapter	21
	List of separate parts	23
PART II:	Projection, Enlargement and Colour Pictures	
	Contabox Miniature Projector	26
	Contax Large Projector	28
	Magniphot Enlarger	30
	Helinox Projection Printer	32
	Colour Pictures	33
	List of separate parts	35
PART III:	Miscellaneous Accessories	
	Dark-room Appliances	38
	Accessories for the Camera	42
	List of separate articles	47

Introduction

A camera which is universal in the truest sense of the word enables use to be made of lenses which can be interchangeably fitted to it as well as of a series of accessories for special purposes. For this reason the Contax has become the base of an entire system of appliances with which the most varied branches of photography are at the command of the user

From the following pages it will be seen that everything photographic can be done with the Contax and the accessories for it. It will be clear that the Contax is not merely a camera with which the most diverse subjects can be taken but is also an instrument adapted for the purposes of serious scientific work.

The special Contax construction—in particular, the detachable back, with consequent accessibility of parts, and the bayonet-joint mount for lenses etc.—has the very great advantage that every accessory appliance is extraordinarily convenient and reliable in use.

Note: The data respecting degree of enlargement or reduction which are given under the illustrations refer to the Contax negative.

Part I

Close-up Subjects, Copies and Photo-micro Work

The shortest distance on which the standard Contax lens can be focussed is about 3 ft (90 cm) When it is required to photograph small objects such as flowers, insects, manuscripts, postage stamps etc. on a sufficiently large scale, the camera must be brought nearer In doing this, special arrangements become necessary Either the lens must be drawn out further or its focal length must be reduced by use of a supplementary attachment. In addition, focussing must be done with the utmost accuracy on account of the smaller range of depth of focus when an object is photographed on a large scale.

Moreover, when making copies with the Contax, it will be a rule to use shorter lengths of film. This is quite practicable in the ordinary use of the Contax cassettes, since these latter may be loaded with the short lengths of film which are preferable. Furthermore, special subjects may be taken on plates with the aid of the plate adapter By the use of this accessory the Contax can be employed like a plate camera. A separate plate-holder is used for each exposure, and focussing can be done on the ground-glass screen.

In a similar way the Contax can be used as a universal camera for taking photomicrographs. The apparatus supplied for this work is so simple and so effective for its purpose that it can be used with as much success for subjects usually calling for professional skill as for those which the amateur is accustomed to take.

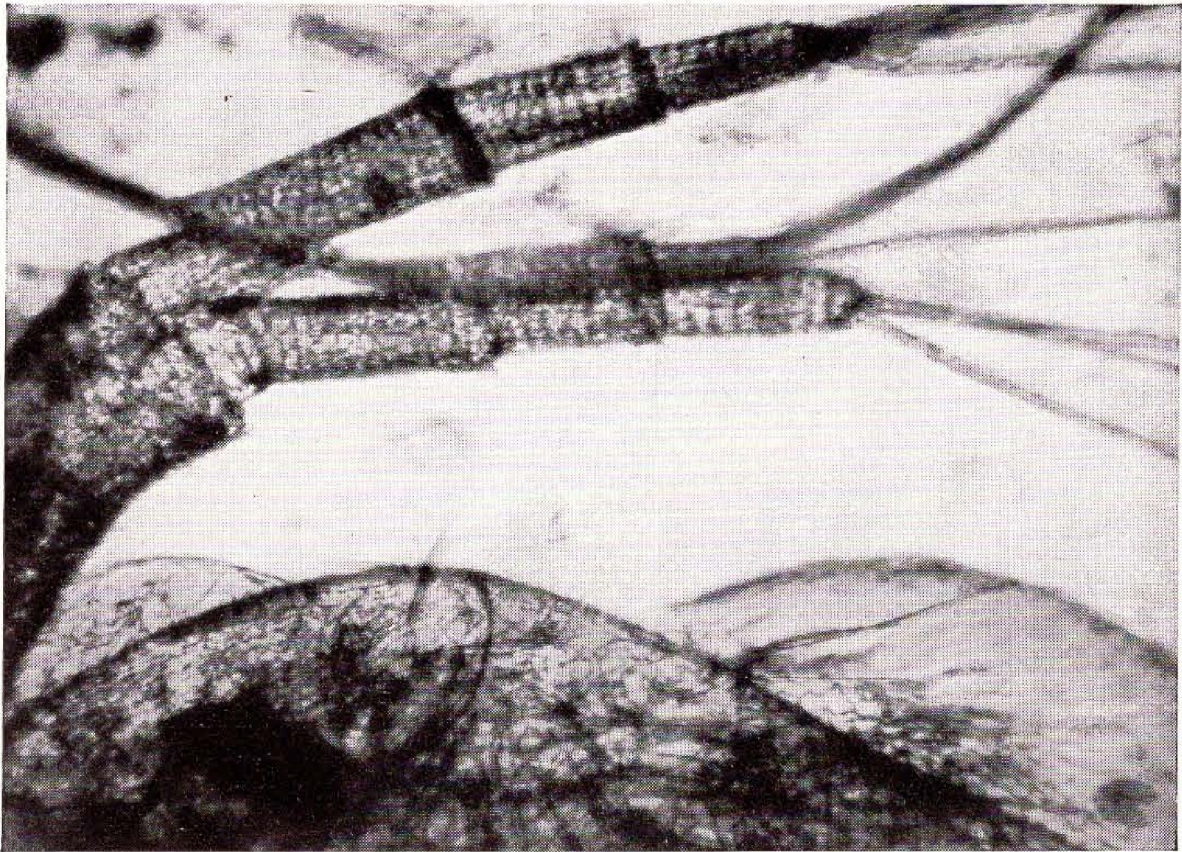

CLAW OF WATER FLEA

Contax Photo-micrograph
100 diams. $\frac{1}{10}$ sec.

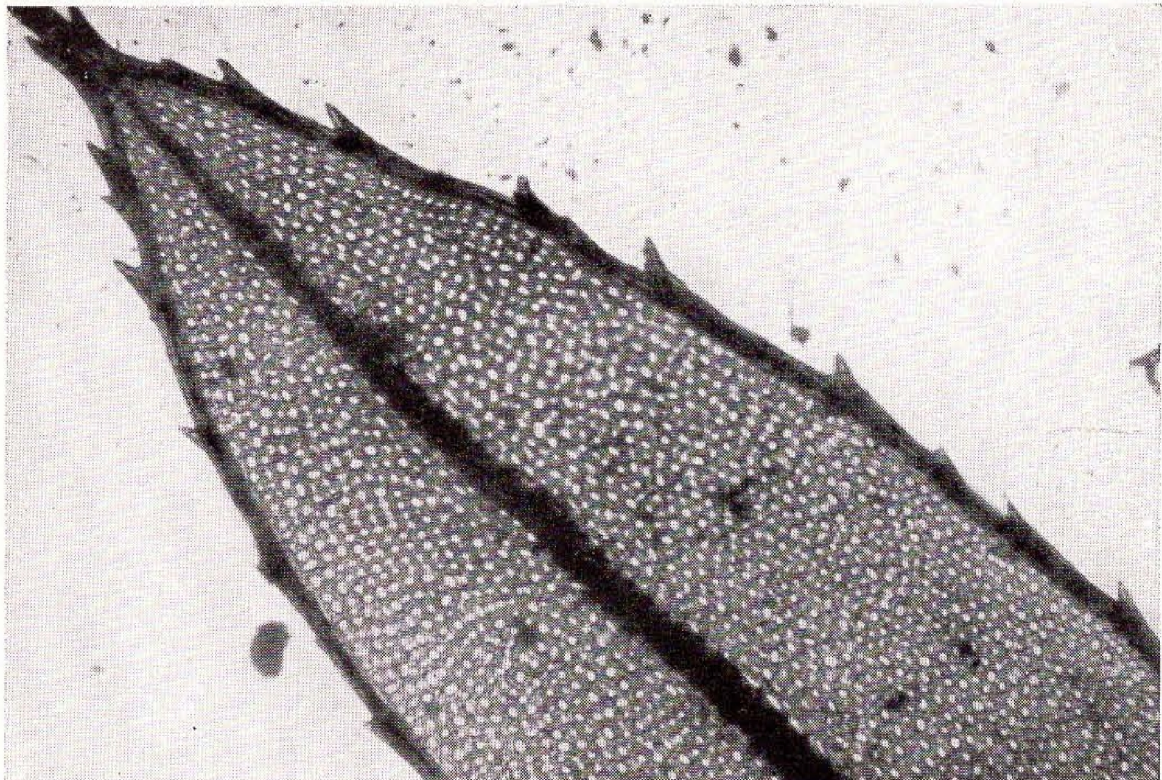

LEAF MOSS

Contax Photo-micrograph
50 diams. $\frac{1}{25}$ sec.

1. Use of Supplementary Lenses

For use with standard Contax lenses of 2 ins (5 cm) focal length there are two Proxars, viz supplementary lenses of one or two diopters (fig. 1). These allow of focussing on objects at distances 36 to 20 ins (90 to 50 cm) and 20 to 12 ins (50 to 30 cm)



Fig. 1 Supplementary lens

The following table gives the distances on which focus is obtained when using the Proxars in conjunction with the focussing scale of the camera lens. The distance of the object from the front of the camera must be accurately measured with a ruler or tape measure, so that the camera will almost always be used on a tripod or other support.

Camera lens $f/1.5$ at $f/8$ set to	Focus obtained with Proxar "1"	Focus obtained with Proxar "2"	Camera lens $f/1.5$ at $f/8$ set to	Focus obtained with Proxar "1"	Focus obtained with Proxar "2"
feet			m	m	m
3	1 8 ¹ / ₂ '	1 2 ¹ / ₄ '	0,9	0,51	0,36
4	1 11 ¹ / ₂ '	1 3 ⁵ / ₈ '	1,0	0,54	0,38
5	2' 1 ¹ / ₂ '	1 4 ¹ / ₂ '	1,15	0,57	0,395
6	2' 3 ¹ / ₈ '	1 5 ¹ / ₄ '	1,3	0,60	0,405
7	2' 4 ³ / ₈ '	1 5 ⁵ / ₈ '	1,5	0,64	0,425
8	2' 5 ³ / ₈ '	1 6'	1,7	0,67	0,435
9	2' 6 ³ / ₈ '	1 6 ¹ / ₄ '	2,0	0,705	0,45
10	2' 7 ³ / ₈ '	1' 6 ¹ / ₂ '	2,5	0,755	0,465
12	2' 8 ⁵ / ₈ '	1 6 ⁷ / ₈ '	3,0	0,79	0,48
15	2' 9 ³ / ₄ '	1' 7 ¹ / ₄ '	4,0	0,845	0,495
20	2' 11'	1 7 ³ / ₄ '	6,0	0,90	0,515
30	3' 5 ⁵ / ₈ '	1 8 ³ / ₈ '	10,0	0,95	0,535
50	3' 2 ¹ / ₄ '	1 8 ³ / ₄ '	20,0	1,00	0,545
100	3' 3 ³ / ₄ '	1 9'	∞	1,05	0,555
∞	3' 4 ¹ / ₂ '	1 9 ¹ / ₂ '			

Sharp focussing and the inclusion of the correct amount of subject are greatly facilitated by attaching the Contax to the tripod by means of the Ball Head (fig. 2) and by examining the image on the ground-glass screen which can be put in place after taking off the camera back.

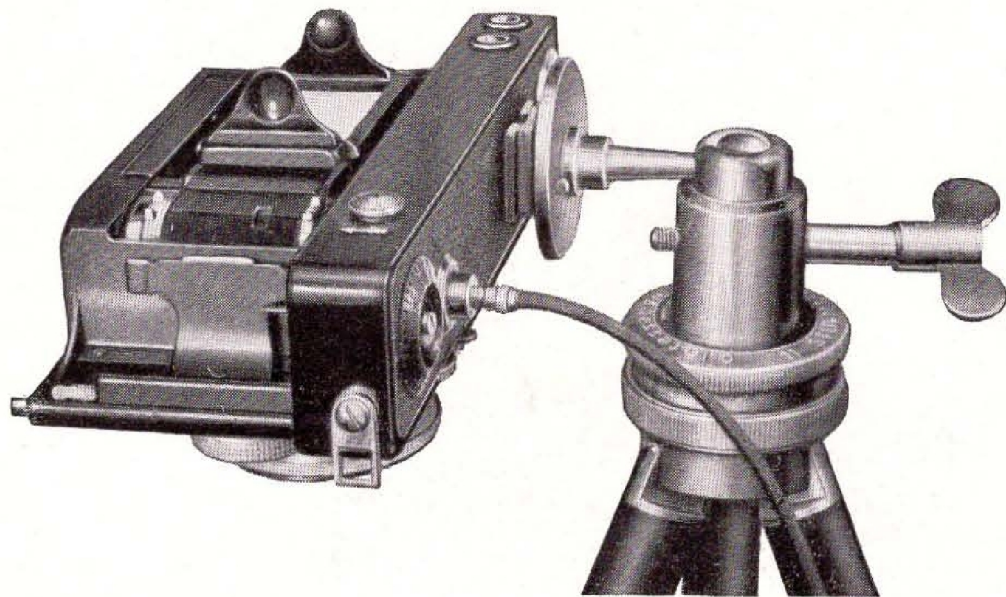
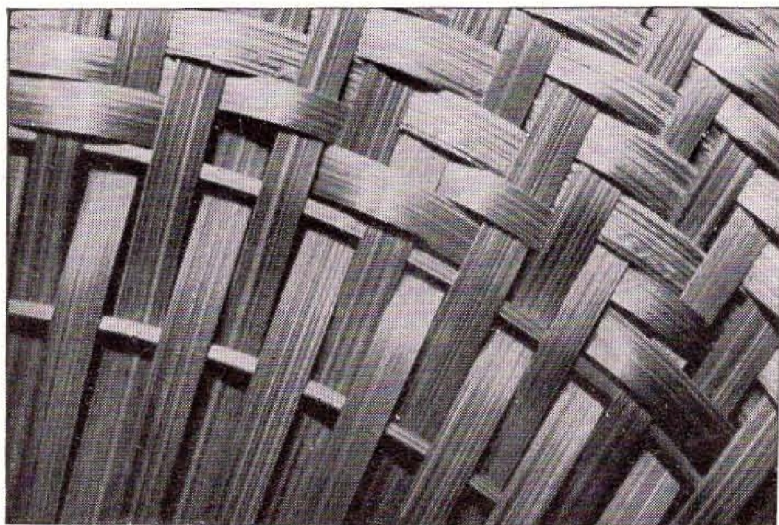

Fig. 2 Contax with special ball and socket head and focussing screen attachment in use for vertical photography

The image is sharply focussed with aid of the Magnifier, the film is inserted in the usual way (with two cassettes) and the camera closed. The camera having been accurately set in focus, any number of copies may be made, without requiring any complicated special appliance.

List of articles p. 23.

Arc lamp, 10-amp,
3 ft distance.
Special Copying
Attachment with 2-inch
 $f/3.5$ Zeiss Tessar at
 $f/22$. Exp. 3 secs.
Copied same size



PALM FANS

Photo Fiedler

2 *Optical Near Focussing Equipment*

For use with this accessory, there are also available lens attachments, of two, three and five diopters, for use with subjects at distances of 20, 13 and 8 ins (50, 33 and 20 cm). By means of this ingenious optical appliance (fig. 3), subjects very close to the camera may be taken without a tripod—in fact instantaneous exposures with the camera held in the hand. It is a kind of distance-meter, comprising



Fig. 3 Attachments for near focussing

interchangeable prisms by means of which it can be set in focus on the distance corresponding with the supplementary lens in use. The camera is moved towards and away from the object until the two parts of the image in the Near Focusser coincide, just as they do in the usual distance-meter

For these near subjects it is of great importance that the finder should be free from parallax error. Such is the case with the Near Focusser, since the distance-meter also functions as a finder with compensation for parallax

The Near Focuser provides the means of taking instantaneous photographs out of doors of flowers, small animals, insects etc. and also medical records of eyes (fig. 4), teeth and any parts which are being operated on. These shutter exposures are made with extraordinary ease, with

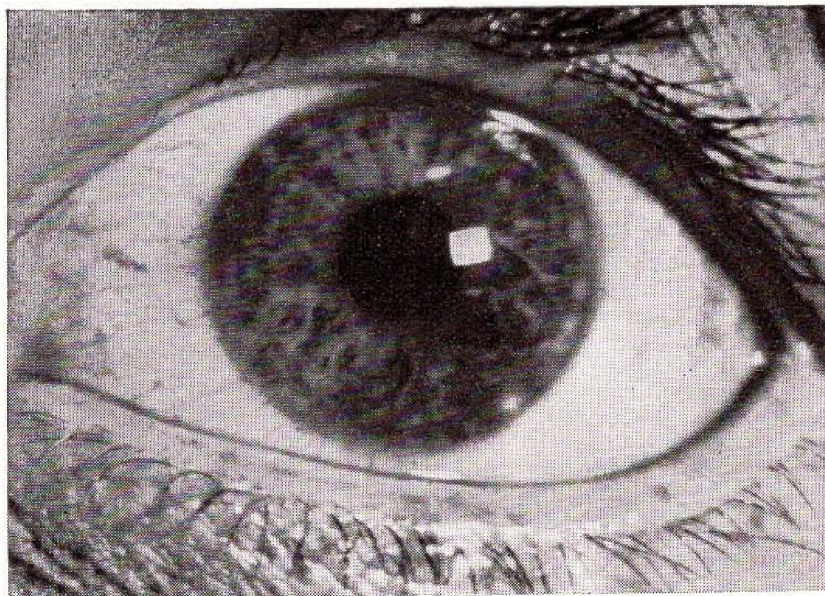
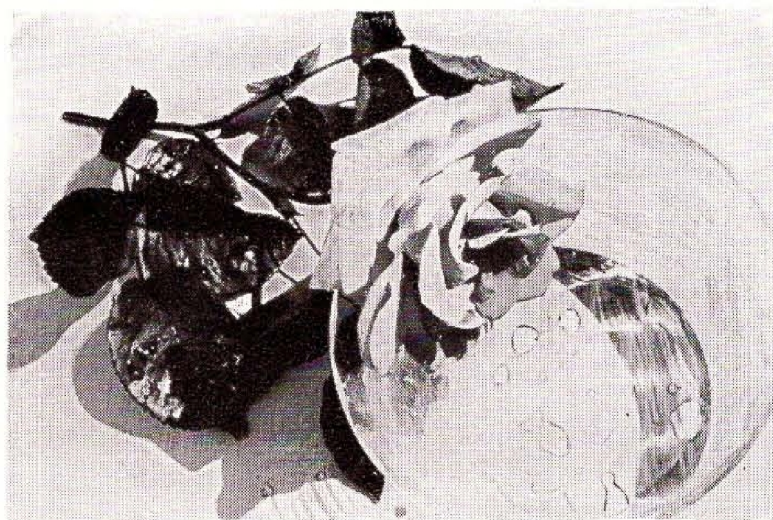

Fig. 4
Human eye. Con-
tax photograph
at 1 ft distance

the camera in the hand, and with complete certainty as regards sharpness and inclusion of the desired part of the subject.

List of articles p. 23.

Elect. are light,
2-inch Zeiss Tessar
 $f/2.8$ at $f/22$
Proxar lens
 2×27
Exp. 15 secs.



ROSE WITH DROPS OF WATER

Photo Fiedler

3. Large Copying Stand and X-ray Plate Copying Apparatus

This apparatus (fig. 5) serves for the making of copies of flat originals and for reproduction of small objects on scales of reduction ranging from 1:2 to 1:14. Hence it provides collectors, scientific men, literary students and others with the means of making exact records of MSS, models, prints, museum specimens etc. on continuous lengths of film and thus of acquiring a collection in the simplest manner. The Copying Stand likewise serves excellently for the production of systematic records of

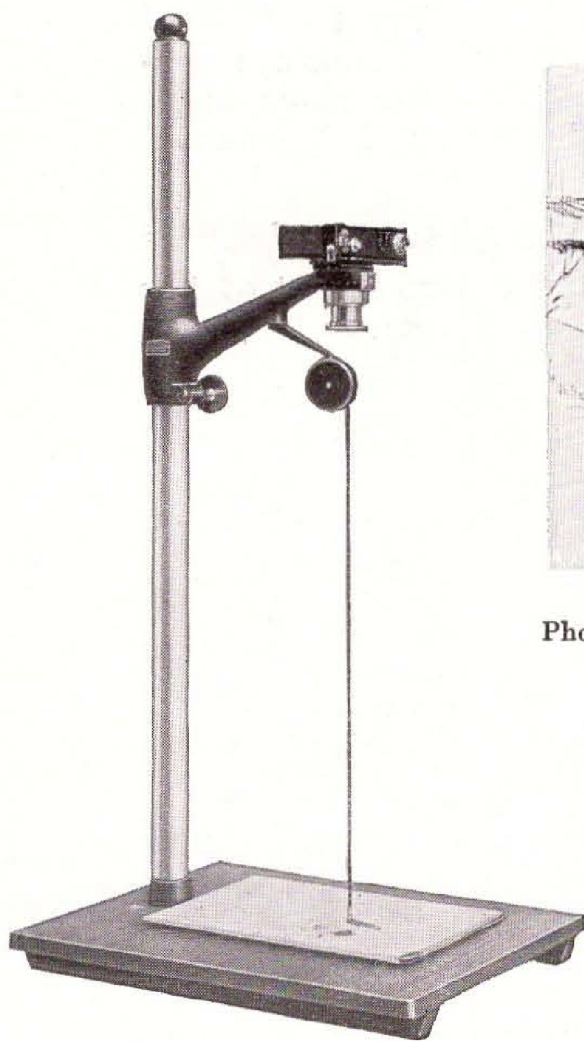

Photo Kammerer With large Copying Stand,
daylight, 2-inch Tessar $f/3.5$ at $f/16$. Exp.
2 secs. Scale of reproduction 1:4

Fig. 5 Large Copying Stand

any kind. The strips of negative so obtained are printed on positive film and can then be shown in full detail at any time on a large screen by means of the Contax Projector. Enlargements (of any size) on paper can of course also be made.

The bracket of the Copying Stand can be supplied separately for use with the baseboard and upright of the Contax Magniphot Enlarger. As the Contax lens serves for copying, the only item to be purchased by possessors of the Enlarger is the bracket of the Copying Stand. The complete Stand is of course supplied, in cases where none of its component parts are available.

When using Contax lenses in sunk mounts, supplementary lenses are dispensed with by means of a special catch device. For lenses in non-sunk mounts, such as the 2-inch Sonnar $f/2$, the three Delta supplementary lenses (No. 995/32) are employed.

Focussing is done according to a table with aid of a spring steel measure, the lens being adjusted by means of the helicoidal mount fitted to the apparatus. Of special advantage in this branch of work is the facility of focussing on the ground-glass screen, since the distribution of light and shade can be effectively judged, depth of focus adjusted and the correct stop ascertained by actual trial. In consequence of the bayonet mount, the adapter carrying the ground-glass focussing screen can be attached to the Contax, or removed from it, with extreme ease.

Unless copying can be done by daylight, it is well to employ the illuminating equipment (fig. 6), consisting of two lamps mounted on a suitable bracket.

The arrangement is devised so as to allow of the lamps being adjusted over a wide range, thus yielding any type of illumination. This system is such that letterpress and similar originals, kept flat under a sheet of plate glass, are illuminated with complete absence of reflections.

For copying transparent originals, the illumination must of course be from below, the light passing through the

original. For this purpose, frames for illumination by transmitted light, are available in the sizes 7×5 , $12 \times 9\frac{1}{2}$ and 20×16 ins (fig. 7). The legs are detachable.



Fig. 6 Large Copying Stand with illuminating arrangement

As illuminant, the equipment described on p. 13 (with two lamps) is employed; when properly placed and when using a white reflecting surface, the illumination is sufficiently even throughout the aperture of the frame. When em-

ploying the 20×16 in. frame the height of the standard upright does not suffice. In this case an extension piece is fitted to the upright, and the Contax thus arranged point-

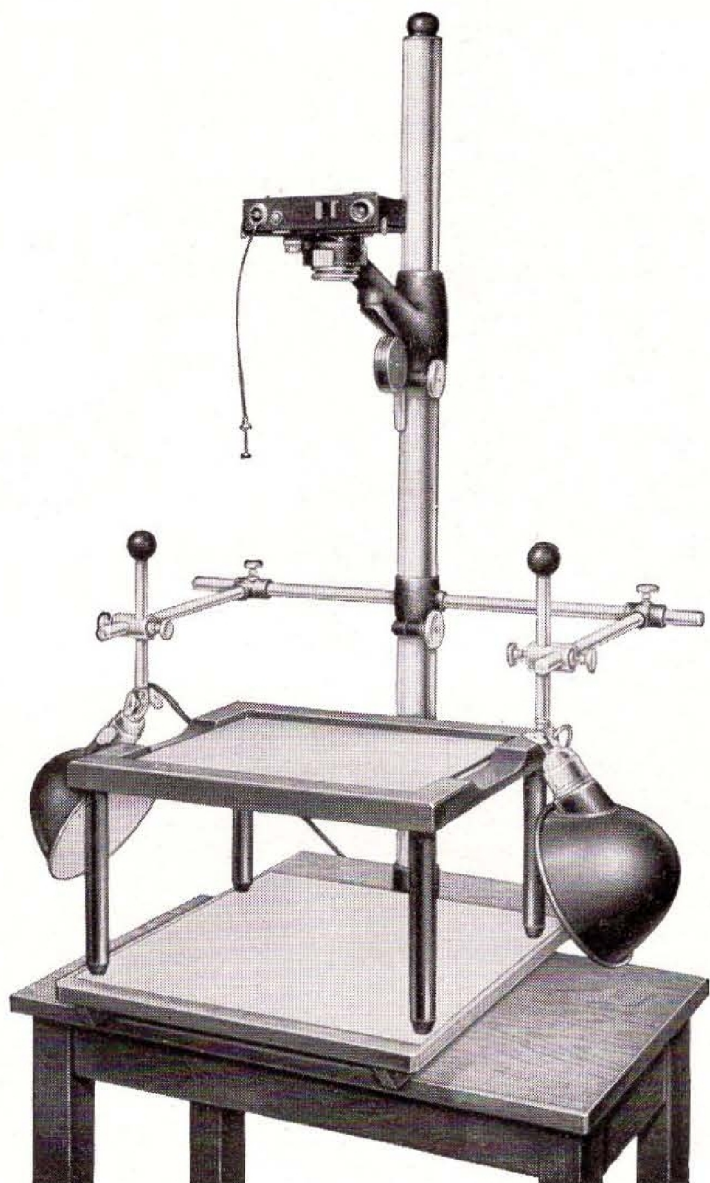
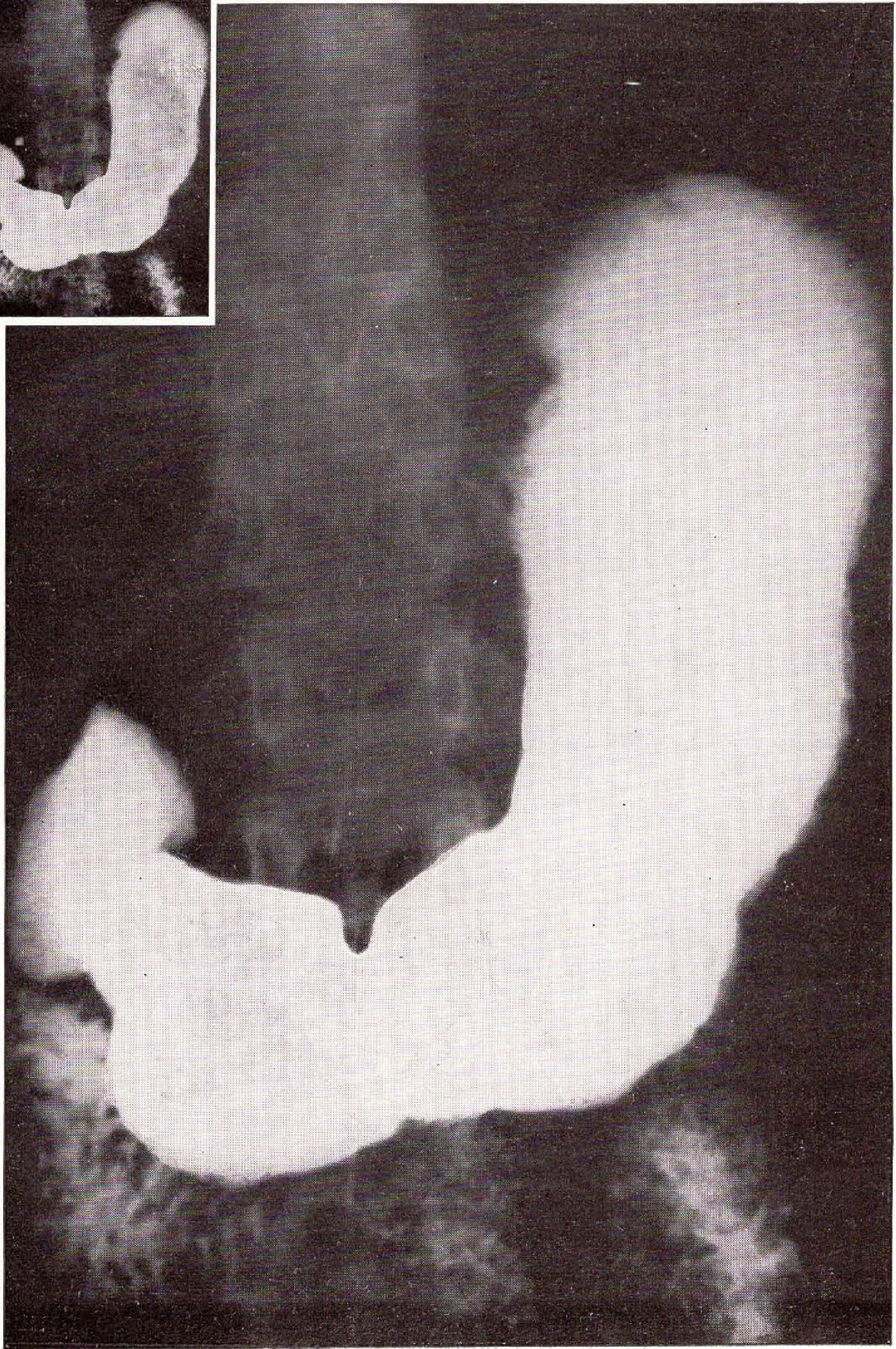
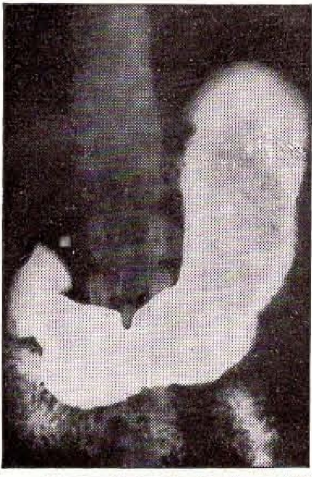

Fig. 7 Large Copying Stand with illuminating arrangement, and frames for illumination of X-ray plates by transmitted light

ing downwards to the centre of the frame. For illumination by transmitted light, it is advisable to use four lamps as shown in fig. 8.

This arrangement is admirable for making copies



Reproduction of an
X-ray $12 \times 9\frac{1}{2}$ " negative
of stomach

Large Copying Stand with illuminating arrangement
for X-ray negatives with two lamps. 2-inch Zeiss
Tessar $f/2.8$ at $f/11$. Exp. 8 secs.

of large X-ray negatives, which can then be most conveniently shown by projection to audiences of considerable size

Fig. 8
Large Copying Stand
with frames for illumination
of X-ray plates (20 × 16 ins)
by transmitted light

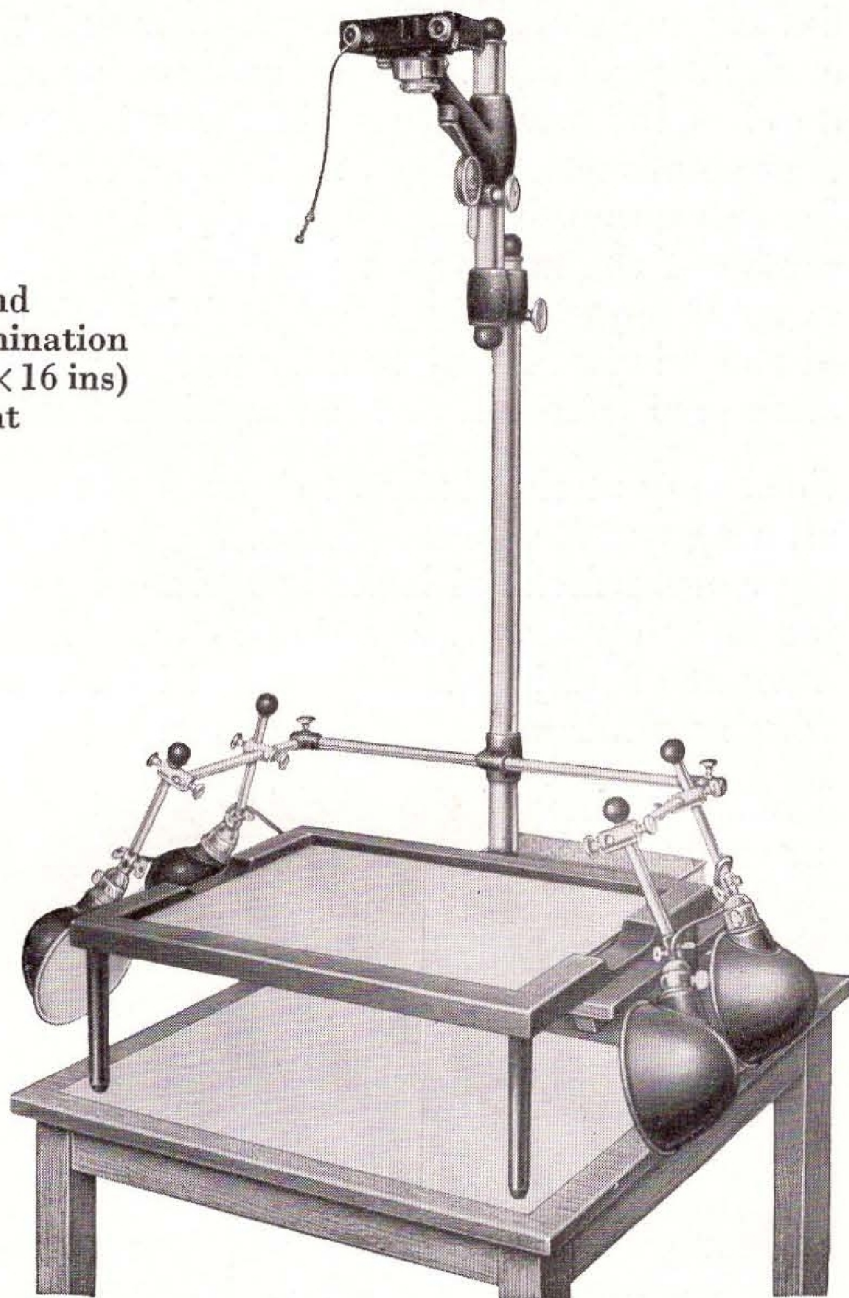

Also a number of negatives of various sizes can be printed on to one length of positive film, which can then be shown on the screen in unbroken sequence by means of the Contax projector

List of articles p. 23.

4. *Special Copying Stand*

This apparatus is especially adapted for making copies of flat originals and photographs of small objects same size or slightly reduced. The apparatus is provided with setting notches for semi-automatic focussing over the range of degrees of reduction — 1:4, 1:3, 1:2, 1:1½, 1:1. Moreover focussing may be done by inspection on the ground-glass screen of the adapter, a most valuable facility in the case of solid objects. The bayonet joint of the Contax allows of the adapter being readily put in place, and the image examined with aid of the magnifier 5520/7.

Focussing at the different degrees of reduction is done by altering the focal extension of the lens with aid of connecting rings, which are locked together by reciprocal bayonet joints. Supplementary lenses are not required. The amount of subject is determined by the masks (see fig. 9), which are interchangeable in the baseboard of the stand.

The operation of the Special Copying Stand is of such extreme convenience and reliability that the making of

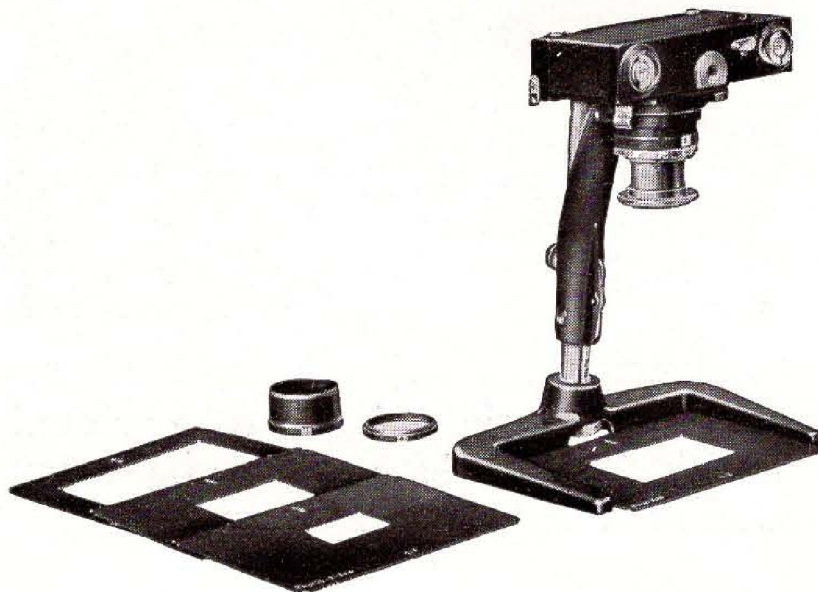

Fig. 9 Special Copying Stand

copies of all descriptions, which ordinarily presents numerous difficulties, is carried out with the greatest ease. The construction affords shadowless illumination in all directions. The position of the upright which carries the camera also permits of copying by daylight.

List of articles p. 24.



Reproduction
on scale of 1:3

Daylight, 2-inch Zeiss Tessar $f/3.5$
at $f/8$, 15 secs.



Reproduction
on scale of $1:1\frac{1}{2}$

Daylight, 2-inch Zeiss Tessar $f/3.5$
at $f/9$, 20 secs.

Copies of an engraving with special Copying Stand

Photo Fiedler

5 Accessories for Photo-micrography

Users of microscopes constantly experience the need of making photographic records of what is observed. This is the case among botanists, zoologists, doctors, chemists and in the numerous institutions where microscopic examinations are undertaken.

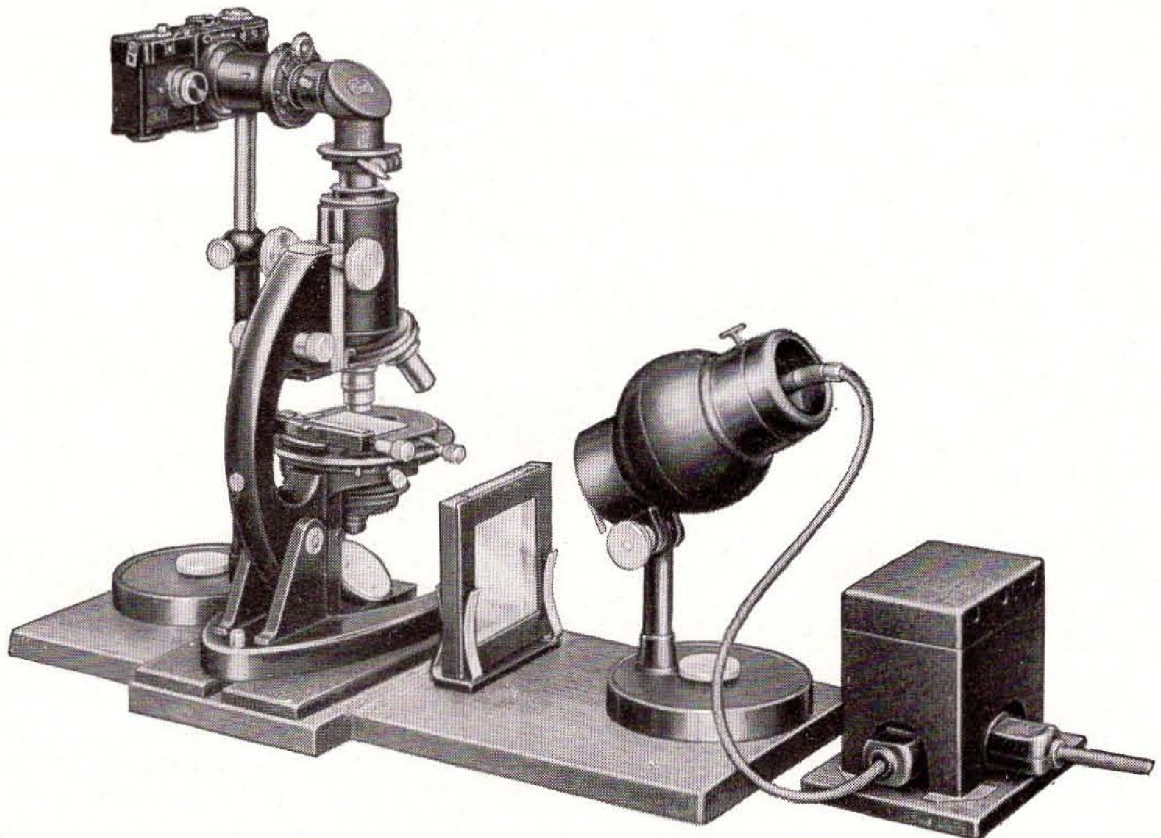

Fig. 10 Complete Micro Equipment with Prism[®] Attachment

The Contax may be converted into a photo-micrographic camera by means of the minimum of accessories of a simple kind. The photo-micrographic accessories have been designed so that a complete outfit for photo and cine micrography, including the apparatus for illumination, may be evolved by purchase of the component parts from time to time. Dimensions have been adopted for these latter, so that any microscope may be used.

In its simplest form the outfit for photo-micrography with the Contax consists of a baseboard with stand and connecting piece for the Contax. This carries the bayonet joint for the camera and the special shutter. An important and advantageous feature is that the Contax is

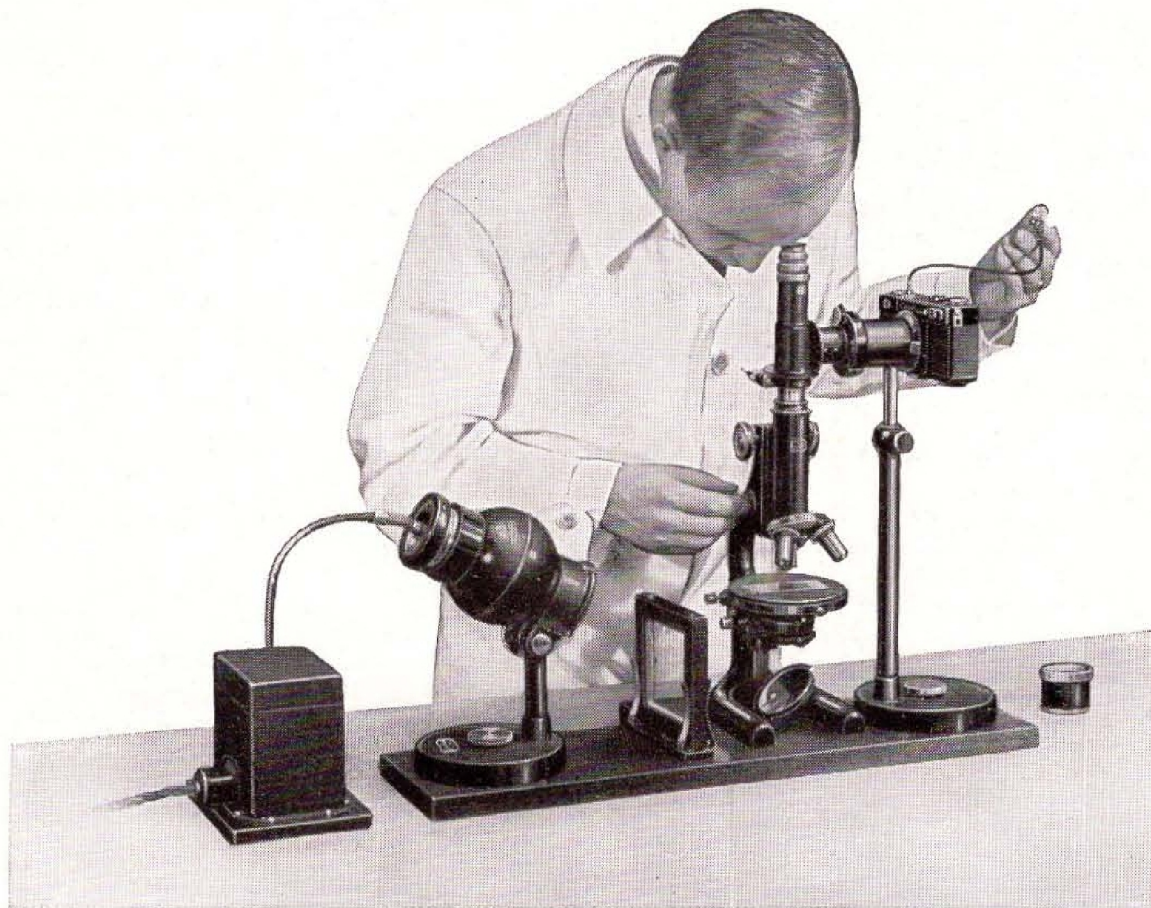

Fig. 11 Micro equipment, using Mikrophot

not rigidly connected to the microscope. Hence any vibration cannot be communicated to it. The necessary diversion of the rays is done by means of a prism attachment secured to the microscope with a collar

Inasmuch as the decisive factor for the success of photo-micrographs, especially at high magnifications, is ample and even illumination, the addition of the illuminator is strongly recommended. This latter consists of a stand with tilting head containing a low voltage lamp, con-

densing lens and diaphragm. A glass cell can also be placed between the lamp and the object for cooling and filtering the light.

Focussing and arrangement of the enlarged image are done on the ground-glass screen, which can be readily fitted to the Contax.

In the case of moving objects, it is essential that the object shall be kept constantly in sharp focus in the microscope and that the required part is in view. This facility is provided in the most effective manner by means of the "Mikrophot" micro attachment (fig. 11) which is employed on the microscope in place of the prism. It contains a prism which splits the pencil of light and causes a minute part to reach the eye. The "Mikrophot" is so arranged that visual sharp focussing automatically focuses the image on the film.

List and prices p. 24.

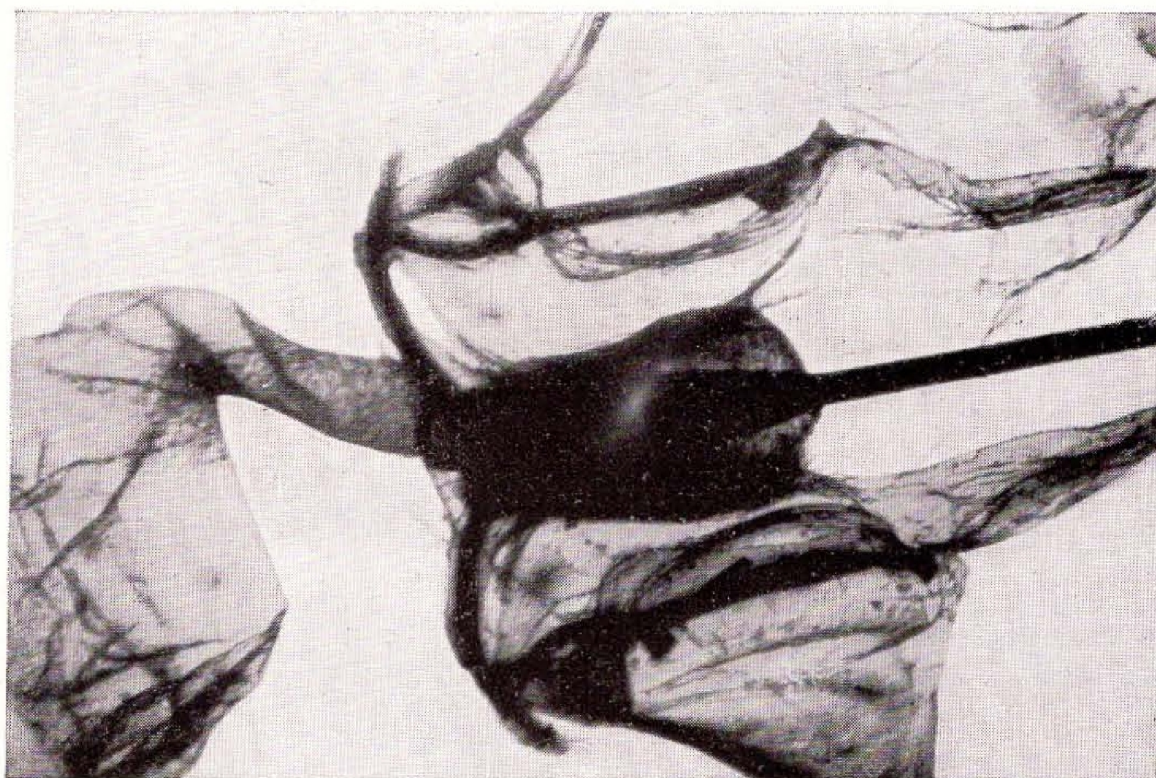

STING OF BEE WITH POISON BAG
Contax Photo-micrograph, 50 diams, $\frac{1}{25}$ sec.

6. Plate Adapter

This Contax accessory has been worked out in response to a widespread demand, namely for the use of the Contax as a plate camera.

Particularly for scientific or research purposes, it is frequently required to make only one or two exposures or to use sensitive emulsion of a kind not obtainable in the form of a special film. Exposures on infra-red and other specially sensitised plates are examples of such requirements.

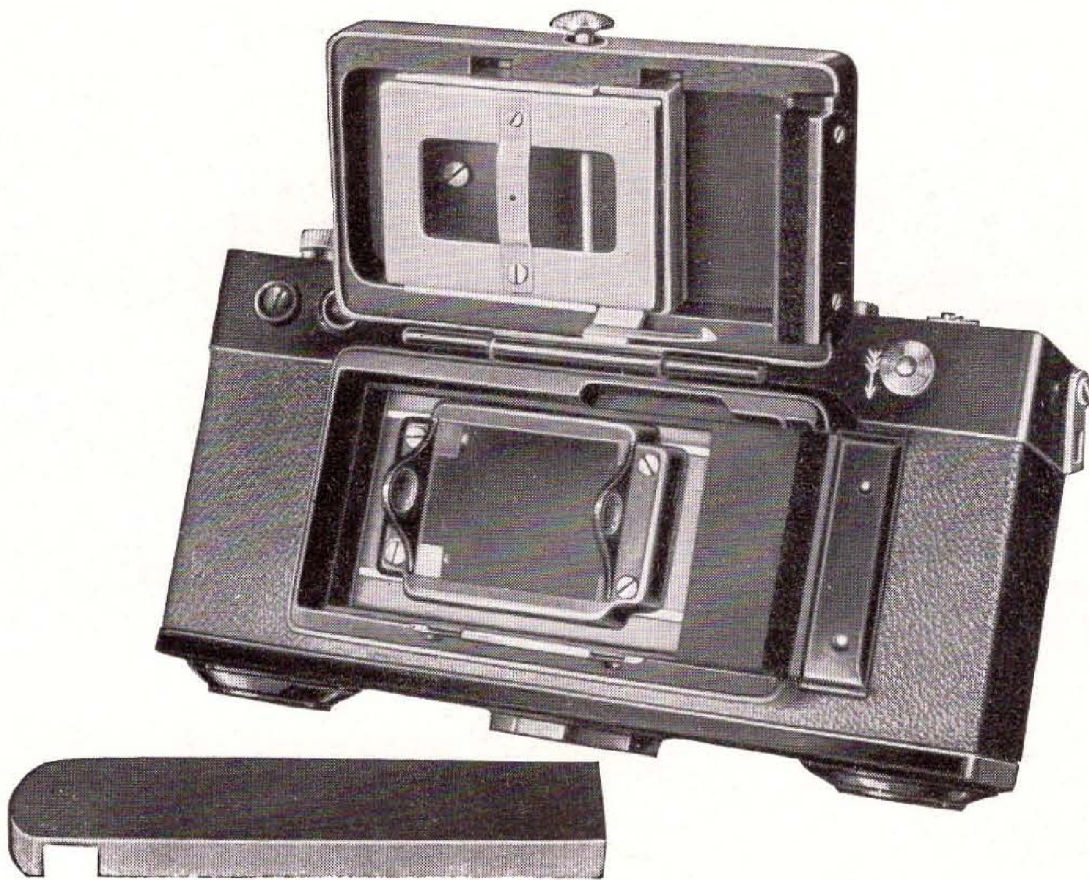

Fig. 12a Contax with Plate Adapter and Ground Glass in place for Focussing

The construction of this plate adapter renders it exceedingly simple in use. The standard back of the Contax is taken off and a second back, carrying the plate adapter, is put in its place. The adapter is opened for reception of the ground-glass focussing screen or a plate-holder of the single pattern. The plates are of $1\frac{1}{8} \times 1\frac{3}{4}$ ins size (3×4.5 cm) and may be cut from those of $4\frac{3}{4} \times 3\frac{1}{2}$ or $3\frac{1}{2} \times 2\frac{1}{2}$ ins (9×12 and 6.5×9 cm). A cutting board is a useful accessory for this purpose. Focussing may be done on the ground-glass screen or with aid of the distance-meter of the Contax.

List of articles p. 24.

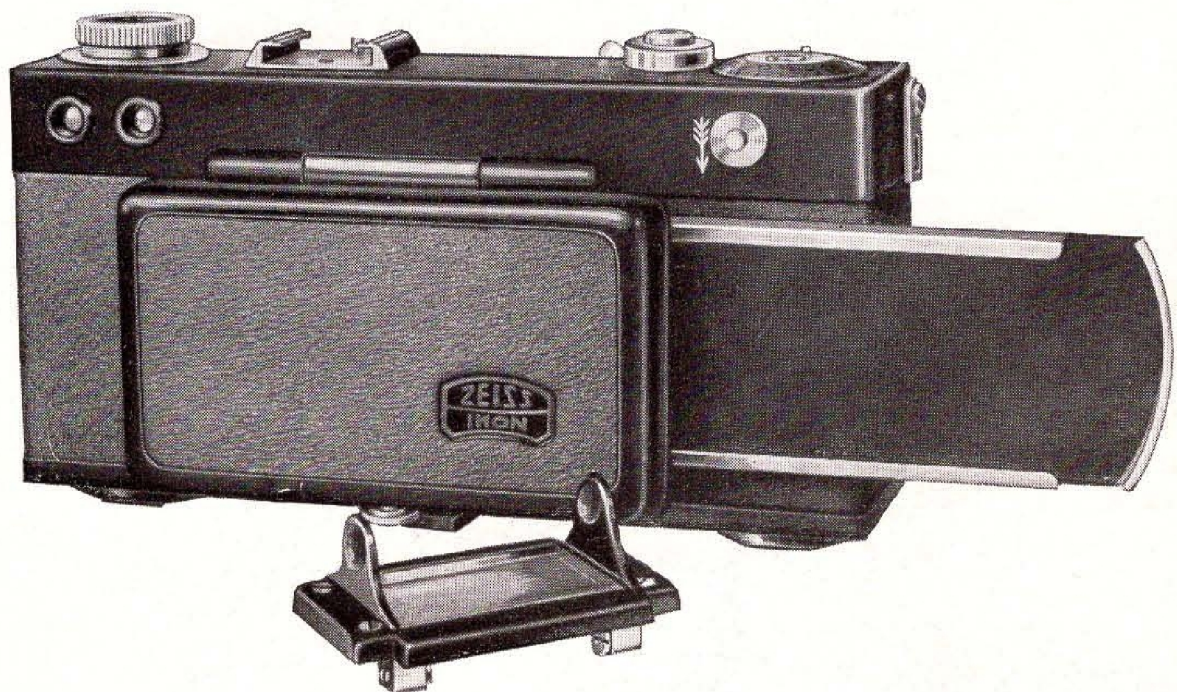

Fig. 12b Contax with Plate Adapter during exposure, plate-holder shutter withdrawn

List of Articles of Part I

Proxar supplementary lenses for Contax lenses 2 ins focal length

	35½—20 ins	20—12 ins
For Tessars <i>f</i> /3.5 and <i>f</i> /2.8	1×27	2×27
For Sonnars <i>f</i> /2 and <i>f</i> /1.5	1×42	2×42
No. 1628/10	Ball and socket joint	
No. 540/11	Focussing screen in frame	
No. 1292	Focussing magnifier (6×)	
No. 1293	Focussing magnifier (10×)	
No. 1343	Optical near focussing equipment complete for 20, 12 and 8 ins, in case	

Large Copying Stand

No. 1454/28	Complete outfit, consisting of upright column, baseboard, illuminating arrangement with two reflectors, copying bracket, focussing screen adapter, but not including lamps
No. 1454/25	Copying bracket, only
No. 1454/26	Baseboard with upright
No. 1454/27	Illuminating arrangement
No. 995/32	Set of supplementary lenses
No. 5520/6	Focussing screen adapter
No. 5520/7	Focussing magnifier to fit focussing screen adapter
No. 1454/32	Extension piece for upright for 20×16 ins negative
No. 1454/33	X-ray plate frame 7×5 ins, without legs
No. 1454/34	X-ray plate frame 12×9½ ins, without legs
No. 1454/35	X-ray plate frame 20×16 ins, without legs
No. 1454/36	Legs for X-ray plate frame
No. 1454/37	Two supplementary reflectors for illuminating arrangement
No. 1557/44	Lamp for illuminating fitting, frosted, 110 volts
No. 1557/45	Lamp for illuminating fitting, frosted, 220 volts

Special Copying Stand

No. 5520/1	Special Copying Stand
No. 5520/0	Wooden case for Copying Stand

Photo-micro Equipment

No. 8009/8	Baseboard for photo-micro outfit
No. 8009/2	Base for connector
No. 8009/3	Connector for the Contax
No. 5520/6	Focussing screen adapter for Contax
No. 5520/7	Magnifier for focussing screen adapter
No. 8009/5	Prism attachment for microscope

- No. 8009/6 Clamping ring for prism attachment or Mikrophot
 No. 8009/1 Illumination unit
 No. 8009/11 Greyscreen for illuminating equipment,
 for dimming the illumination during
 focussing
 No. 5439/9 Lamp, 6 volts 25 watts
 No. 8009/7 Transformer for 110/220/6 volts
 No. 1558/39 Resistance 110/220/6 volts
 No. 811/30 Mikrophot microscope attachment
 No. 811/12 Field of vision diaphragm for Contax
 No. 1471/2 Heat-absorption cell
 No. 8009/9 Holder for cell
 No. 8009/0 Box for complete photo-micro outfit

Plate Adapter

- No. 540/13 Plate adapter with one holder for plates
 30×45 mm
 No. 540/14 Single plate holder for plates 30×45 mm
 No. 540/11 Focussing screen in frame
 No. 2006/1 Gauge for cutting plates $6,5 \times 9$ or
 9×12 cm.
 No. 542/1 1 doz. plates $3 \times 4,5$ cm.
 No. 540/8 Slide carrier for cut films $3 \times 4,5$ cm,
 also for use as template



TOYS. Photo Fiedler

Half-watt lamp, 2-inch Zeiss Tessar $f/3.5$
 at $f/22$, Proxar 2×27 8 secs.



COFFEE BEANS
Photo Kammerer

Daylight, September, 11 a. m.
Special Copying Stand, 2-inch Zeiss Tessar $f/2.8$ at $f/16$,
3 secs. Scale of reproduction 1:2

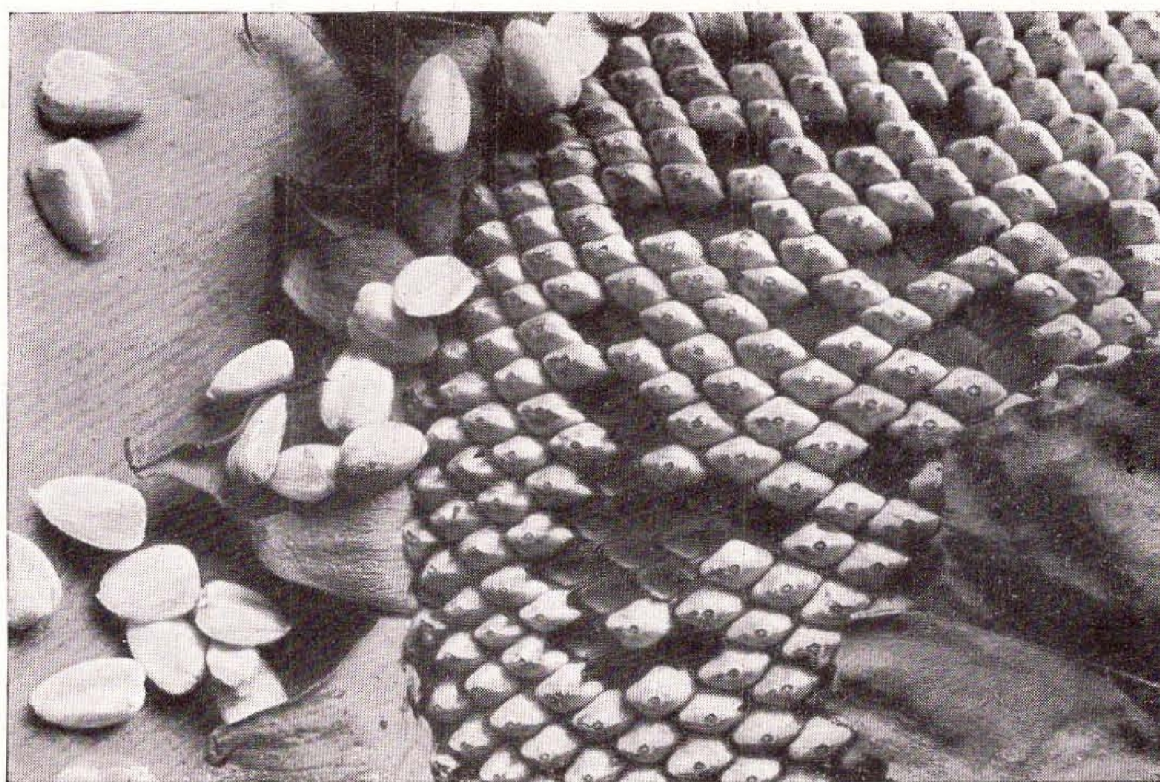

SUNFLOWER
Photo Kammerer

Daylight, September, 11 a. m.
Special Copying Stand, 2-inch Zeiss Tessar $f/2.8$
at $f/22$, 2 secs. Scale of reproduction 1:3

Part II

Projection.

Enlarging and Colour Pictures

1. Projection

At the present time less use is made by amateurs than should be the case of projectors for showing pictures in their homes. In comparison with an ordinary enlargement (on paper) a picture on the projection screen is remarkably effective, particularly so when in colour. The showing of pictures in this way is now a very simple matter.

Two patterns of apparatus are available for the purpose. We will first refer to that of the simpler type—the box projector

Contabox

This projector is for lengths of film pictures of the Contax size $1\frac{5}{16} \times 1\frac{3}{8}$ (24×36 mm) or of the standard cinemato-



Abb. 13 a
Contabox
with Contax lens
of 2 ins focal length

graph size $\frac{3}{4} \times 1\frac{5}{16}$ (18 × 24 mm). It is also adapted for transparencies on glass of picture size up to $1\frac{1}{8} \times 1\frac{5}{8}$ ins (3 × 4 cm) on plates 2 × 2 ins (5 × 5 cm).

A 100-watt projection lamp gives a sufficiently bright picture on the screen of size up to 6 ft (2 m), which is large enough for class rooms and society audiences of moderate size. An excellent quadruplet condenser covering a wide angle, in conjunction with a concave mirror behind the lamp, utilises every ray of the light. The Contax camera lens is used as projection objective.

The Contabox provides the means of exhibiting the photographic quality of pictures on lengths of film to a party of friends with the best possible effect. A collection may be made of films, each illustrating some subject of interest to the maker and his friends. One may be scenes of a holiday; another of sport; others of one's family, children or occupations. Such exhibitions need not be limited to pictures taken with the Contax; by use of a copying stand, pictures or printed matter of any kind or size may be reproduced as transparencies for projection.

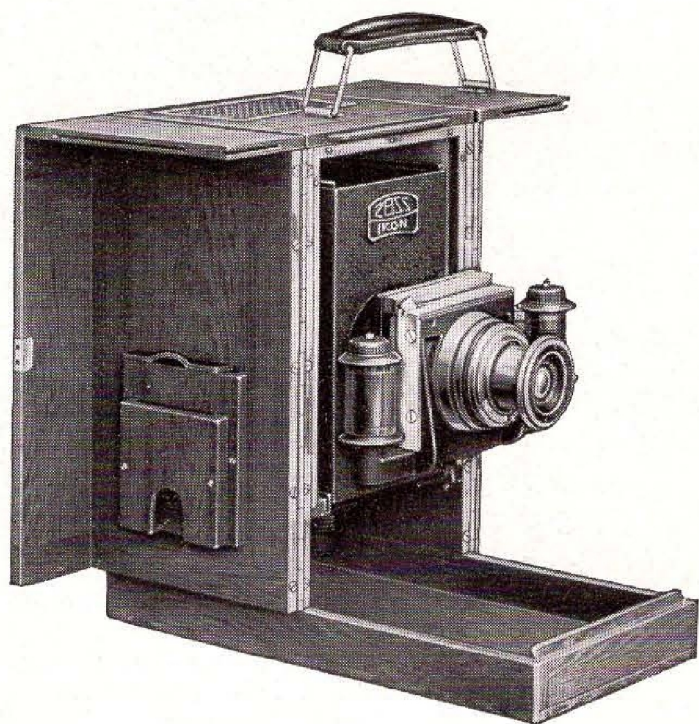
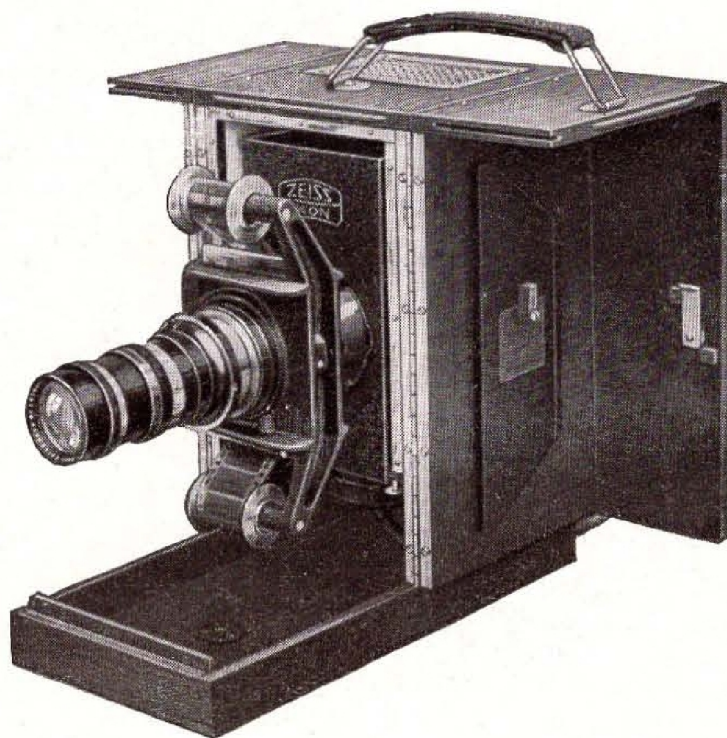

Fig. 13b
Contabox with
 $5\frac{8}{8}$ -inch Zeiss Sonnar

Contax Large Projector

This higher-powered apparatus is for the projection of ordinary photographic transparencies up to a width on the screen of 12 or 13 ft (see p. 33), or Agfacolor colour pictures up to 3 ft. A cooling cell of nearly 4 inches thickness, with automatic safety device, allows of the use of a 250-watt projector lamp without risk of damage to the films by heat.

The apparatus is fitted with a special large-aperture projection lens the Alinar f 2,5 of 4 ins (10 cm) focal length, permitting of its use in large rooms at a distance of more than 30 ft from the screen.

The projector is supplied in two designs, the one with device for the projection of coloured transparencies made according to the Agfacolor process, and the other with-

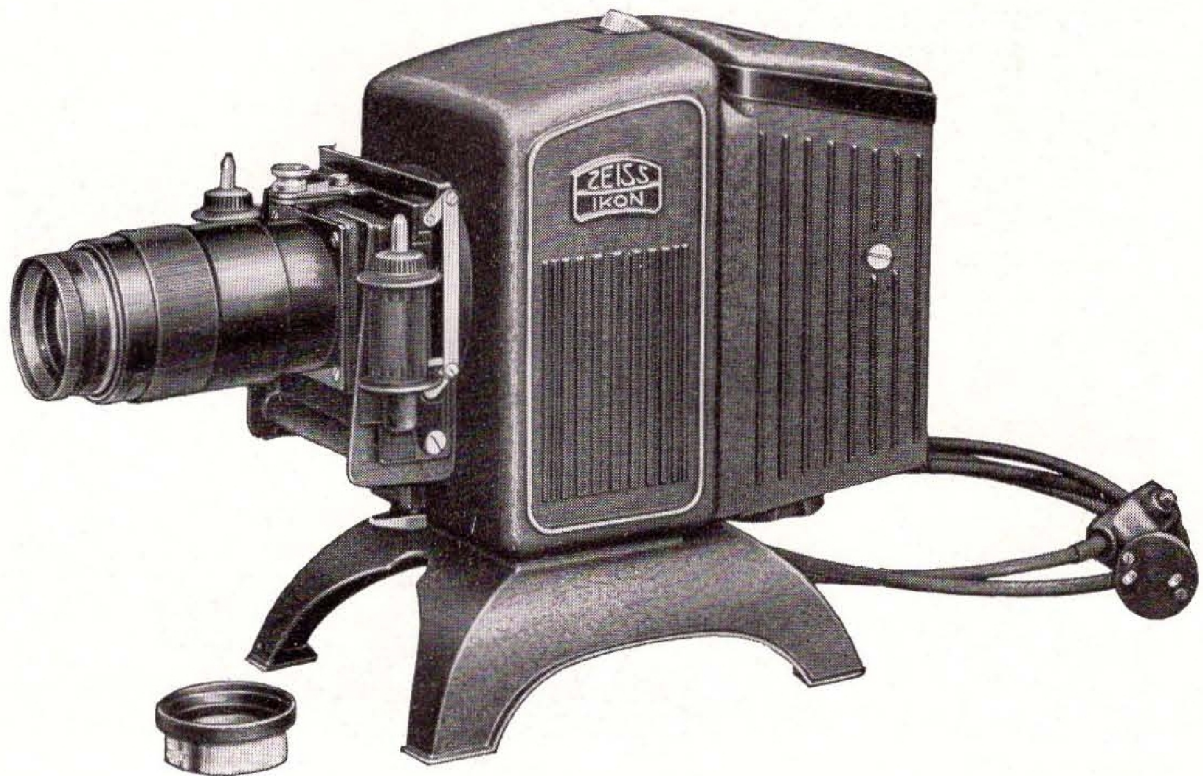

Fig. 14 Contax Large Projector

out this device, i. e. only for black-white views. With the colour projector is supplied a special tricolour filter which must be exchanged with the front lens of the projection objective.

It is best to employ a "silver" projection screen on account of the much greater brightness of the pictures.

List of articles p. 35.



Nitraphot lamp
at 3 ft from subject,
2-inch Zeiss Tessar $f/2.8$
at $f/8$. Exp. 2 secs.
Special Copying Stand
Scale of reproduction 1:3

JAPANESE TAPESTRY

Photo Fiedler

2. Enlarging

The making of the excellent enlargements which are obtainable from the little negatives constitutes a most fascinating part of Contax photography. The Magniphot and Helinox are enlargers which in their several ways enable this work to be done most excellently and readily.

Magniphot Enlarger

This enlarger is specially designed for amateur requirements. The Contax lens is used with it; a separate enlarging objective has not to be bought. Since it is important to be able to make pictures over a wide range of degrees of enlargement, the Magniphot is provided with an upright standard of exceptional length, which is made in



Photo Habermann

June in sun, 10 a. m.
2-inch Zeiss Tessar $f/3.5$
at $f/4$. Exp. $\frac{1}{60}$ sec.

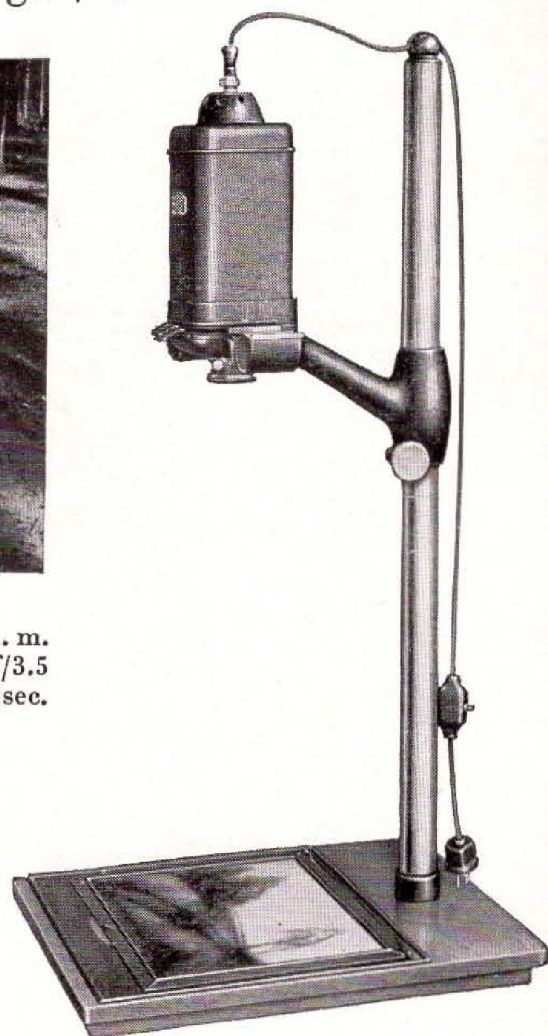

Fig. 15 Magniphot Enlarger

two parts for convenience of carrying or packing. The smallest enlargement which can be made is approximately $3\frac{1}{2} \times 2\frac{1}{2}$ ins (6×9 cm).

The greatest degree of enlargement when using the base-board of the apparatus is 15 diams, but in practice the size of the enlargement is limited by the dimensions of the board to 15×10 ins from a Contax negative. Enlargements of any desired larger size may be made by swinging round the upper part of the apparatus, e. g. to point over the edge of a table to the floor.

The illuminant is an opal lamp in conjunction with a condenser. This system yields a very suitable diffused light, with which well graded enlargements of good brilliance are obtained. Moreover slight defects in the negative, such as scratches on the non-emulsion side and the grain of the image itself, are rendered practically invisible by this type of illumination. Exposures are short even when the Contax lens is stopped down, thus enabling enlargements to be turned out with satisfactory expedition.

In the normal holder for the strip of film two glass plates can be inserted, by means of which enlargements can be made from film negatives (hardened) while still wet. Press photographers will appreciate the usefulness of this feature.

As with all Zeiss Ikon enlargers, the bromide paper is held in one of the metal frames, made in most current sizes. The frame allows of rapid insertion and removal of the paper and is provided with a mask for white-margin pictures.



Fig. 16 Metal frames for holding and masking paper

Helinox Projection Printer

By many amateurs this enlarger or projection-printer of simpler construction will be found sufficient. It is made to work at one fixed degree of enlargement, yielding prints of $3\frac{1}{2} \times 2\frac{1}{2}$ ins or $4\frac{3}{4} \times 3\frac{1}{2}$ ins size. The enlarger is fitted with artificial illumination from electric lamp and can also be used with daylight. The lens is an $f/6.3$ anastigmat.

List of articles p. 36.



Fig. 17
Helinox printer

¹ April, 3 p. m. sunshine
 $5\frac{3}{8}$ -inch Zeiss Sonnar $f/4$. Exp. $\frac{1}{100}$ sec.



Photo Schneider

3. Colour Pictures

Pictures in natural colours may be taken with the Contax by using the Agfacolor film, a special film prepared with a lenticular formation of the transparent base. The exposures require to be made with the 2-inch Tessar $f/2.8$ or Sonnar $f/2$ or the $3\frac{3}{8}$ -inch Sonnar $f/2$. The only other accessory needed for use with these lenses is a special tri-colour filter, which is attached either to the outer bayonet joint of the Contax or to the lens itself. The filter is provided with a straight guide, since the colour bands of the filter must always be placed in the same position relatively to the film, whatever may be the adjustment of the lens. It is hardly necessary to add that the above-mentioned colour lenses serve equally well for ordinary use.

The Agfacolor film is supplied in cartridges, each containing film for 18 exposures.



Fig. 18a Contax with 2-inch Zeiss Tessar $f/2.8$ and Colour Filter



Fig. 18b Contax, $3\frac{3}{8}$ -inch Sonnar $f/2$ and Colour Filter

Development and reversal may be done by any amateur by means of a special developing frame. There is no printing in this process; the film is developed as a negative and then converted into a positive. These Agfacolor pictures in colour can only be shown by projection, the high-power Contax Large Projector being used for this purpose. (For further particulars, see under "Projection".)

List of articles p. 36.

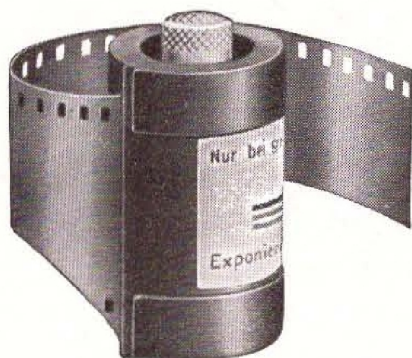

Fig. 19
Agfacolor Cartridge

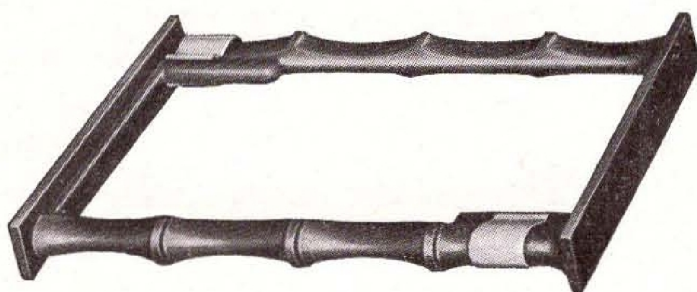

Fig. 20
Developing Frame for Colour Film

List of Articles of Part II

Contabox B

- No. 1426/1 Contabox B with carrier for single slides 2×2 ins ($2\frac{1}{4} \times 2\frac{1}{4}$ ins on request), and masks 18×24 mm and 24×36 mm, heat absorbing screen, 100 watt 110 volt lamp and 6 ft electric flex
- No. 1426/2 Contabox B with 100 watt 220 volt lamp (if required with lamp for 125 or 150 volts, kindly state in ordering)
- No. 1426/3 Contabox B with 100 watt 30 volt lamp and resistance for connection to 110, 125 and 220 volts (continuous and alternating)
- No. 1426/4 Contabox B with 100 watt 30 volt lamp and transformer (saves current) for connection to 110, 125 and 220 volts (for alternating current only)
- No. 1426/12 Lens panel with film stage, heat-absorbing screen, carrier, mask 18×24 mm or 24×36 mm, attachment tube and special lens in tubular mount
- No. 1425/11 Brown sail-cloth cover for the box
- No. 1576 Small convenient screen to roll up like a map, with supports and cardboard tube. Size 3×3 ft

Contax Large Projector

- No. 1429/21 Large Projector with device for the projection of coloured transparencies made with the Contax with lamp 250 watts 110 volts or Super Nettel and lenses of 2 ins focal length
- No. 1429/23 The same as No. 1429/21, but with resistance for connection to 220 volts
- No. 1429/22 Large Projector with device for the projection of coloured transparencies made with the Contax and lens of 8,5 cm focal length*, with lamp 250 watts 110 volts
- No. 1429/24 The same as No. 1429/22, but with resistance for connection to 220 volts
- No. 1429/1 Large Projector for black-white transparencies 24×36 mm, with lamp 250 watts 110 volts
- No. 1429/2 The same as No. 1429/1, but with resistance for connection to 220 volts
- No. 1429/0 Carrying case for No. 1429/21, 1429/22, 1429/1

* When ordering please state distance between transparency and filter—60 or 120 mm.

- No. 1429/00 Carrying case for No. 1429/23, 1429/24, 1429/2
 No. 1557/46 Lamp 250 watts 110 volts
 No. 1577/5 Silver screen for colour projection 75 × 100 cm
 (2¼ × 3 ft)

Magniphot

- No. 1454 Magniphot Enlarger, without lamp or lens
 (the Contax lenses are used for the enlarging)
 No. 1454/22 Pair plate-glass sheets for enlarging wet strips
 of film
 No. 1557/49 Opal lamp 75 watts 110 volts
 No. 1557/50 Opal lamp 75 watts 220 volts
 No. 1454/21 Special anastigmat for enlarging without Con-
 tax lenses

Frames for holding the bromide paper

Size	3½ × 2½	4¼ × 2¼	¼ pl.	4¾ × 3½	5½ × 3½	6 × 4 ins
	6.5 × 9	6.5 × 11	8.3 × 10.8	9 × 12	9 × 14	10 × 15 cm
No. 2674/3	/15	/5	/7	/8	/9	
Size	½ pl.	7 × 5	9½ × 7	12 × 9½	5¾ × 4¼*	ins
	12 × 16.5	13 × 18	18 × 24	24 × 30	10.5 × 14.8*	cm
No. 2674/27	/11	/20	/21	/26		

* International postcard size

- No. 2674/31 Special frame for enlarging from Contax Nega-
 tives on 4¾ × 3½ in. paper

Helinox Projection Printer

- No. 1411/6 For enlargements to 3½ × 2½ ins
 No. 1411/7 For enlargements to postcard (5½ × 3½ ins)
 No. 1557/44 Special lamps, frosted inside, 40 watts 110 volts
 No. 1557/45 Special lamps, frosted inside, 40 watts 220 volts

Colour Pictures

- No. 540/16 Taking filter in mount for 2-inch Tessar *f*/2.8
 540/15
 No. 540/17 Taking filter in mount for 2-inch Sonnar *f*/2
 No. 540/15 Filter holder for Nos. 540/16 and /17
 No. 540/31 Taking filter (standard) for 3⅜-inch Sonnar *f*/2
 in mount for 540/30
 No. 540/30 Filter holder for lens mount of 3⅜-inch Sonnar
f/2
 No. 5426/3 Developing frame for Agfacolor film
 Agfacolor film (cartridge)



Scale of reproduction 1:3

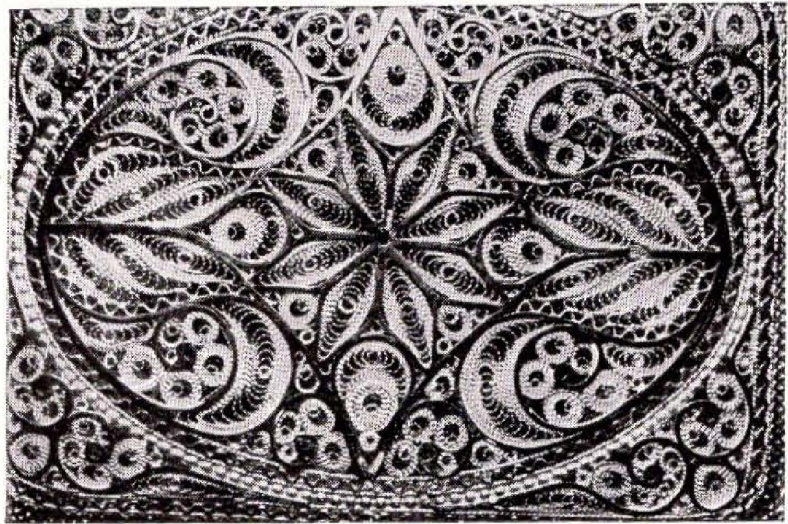

Scale of reproduction 1:2

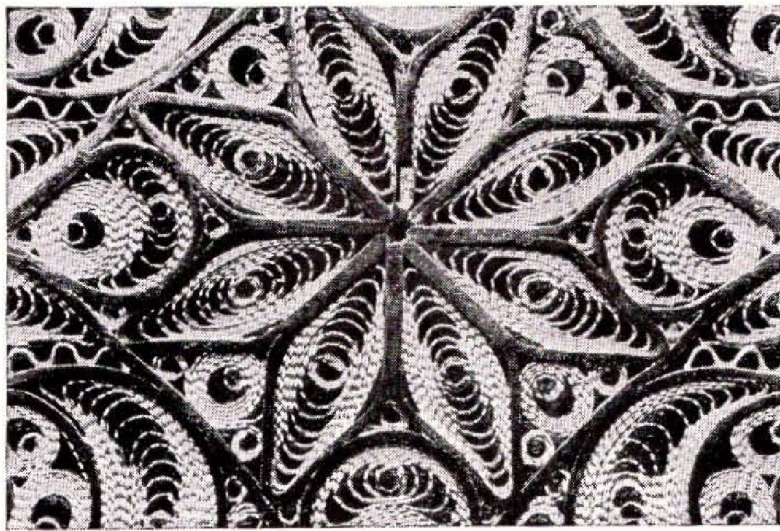

Scale of reproduction 1:1

FILAGREE WORK ON CIGARETTE CASE

Photo Kammerer

With Nitraphot lamp at 3 ft, Special Copying Stand,
2-inch Zeiss Tessar $f/2$ at $f/22$. Exp. 2 secs.

Part III

Miscellaneous Accessories

1 Dark room appliances

Loading of cassettes and also the winding of film on Contax spools must be done in a dark-room. As regards general dark-room equipment, the reader is referred to our catalogue of photographic requisites.

Specially for the handling of Contax film a very suitable lamp is the small *Aladdin*, fitted with three safelights, bright red, dark red and green.

For cutting ends of films, a most useful appliance is a *template* or cutting shape.

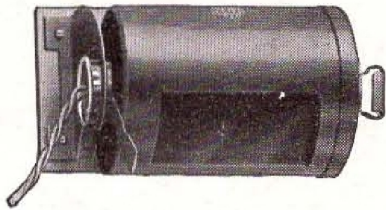

Fig. 21

Aladdin Lamp (small model) Fig. 22 Template for cutting film

Lengths of film which have been exposed in the Contax must be developed in the *Contax Tank*. The tank is designed so that the length of film is coiled on a spiral plate,

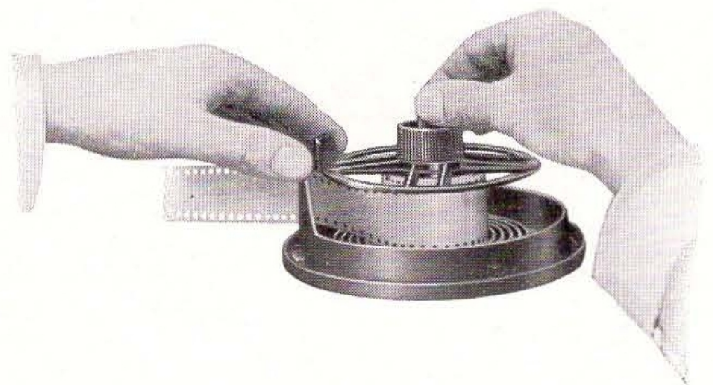

Fig. 23 Contax Tank

Fig. 24 Spiral Plate

and is thus freely exposed to the developer etc., not interwound with a celluloid band. The tank having been closed, the inside fitting with the film can be turned by a projecting head, so as to mix the developer thoroughly during the process of development, as so necessary for good results. (The tank requires about 12 ozs of solution.)

Following development, the film is fixed and washed—also in the tank.

The Contax tank when closed is light-tight, so that the whole process of treating the film except loading may be done by daylight. The film may of course be put into the tank in darkness with aid of a changing bag, an operation, however, demanding more than ordinary care.



Fig. 25 Magnifier with Illuminating Box

Before making use of negatives, it is well to examine them critically for sharpness and amount of subject included.

For this purpose the negative is examined with a *magnifier* of fairly high power. A test of this kind is of importance for all miniature negatives. The appliance provided for this purpose consists of a *negative viewer* with illuminating and marking attachments. By marking the film by punch-

ing a small hole in the perforated side, the user can quickly identify, in the dark-room, the negatives which are to be enlarged.

In many cases it is of advantage to make contact prints from the little negatives, using the *Lilliput printing frame*. A general idea of the effect of the pictures is thus obtained, more especially by using a magnifier

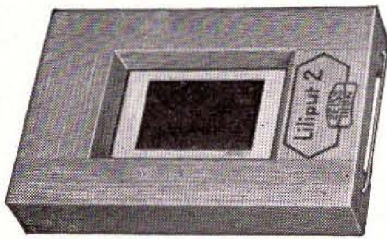

Fig. 26 Lilliput Printing Frame

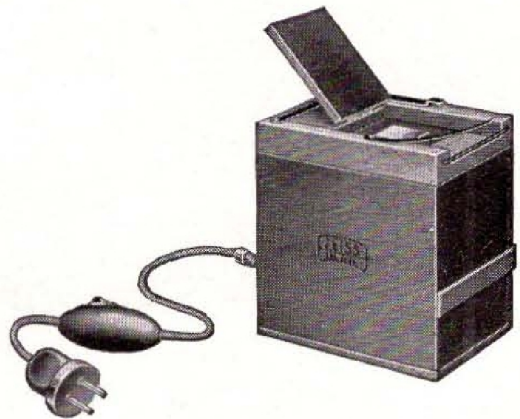

Fig. 27 Printing Box

For making glass transparencies on plates of 2×2 ins or $2\frac{1}{4} \times 2\frac{1}{4}$ ins size, we recommend the small *printing box* which can be obtained for both sizes. An apparatus for printing positives on lengths of film is in course of preparation.

List of articles p. 47

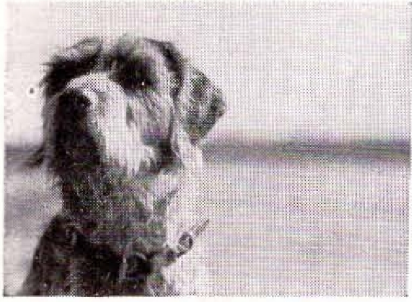

Photo Dr. Class

2 Accessories for the Camera

When making exposures with the camera on a tripod, the *tilting head* (fig. 28) allows of rapid alternation of upright and oblong pictures. The two stops provided on this accessory render it unnecessary to adjust the camera in one or the other position.

For use with the focussing-screen adapter, a *push-on magnifier* serves also as a focussing hood. The full Contax image can be seen when using this magnifier, which is an indispensable accessory whenever focussing is done by inspection of the image on the ground glass.

Several patterns of *lens hood* are available for the Contax lenses, e. g. a simple inexpensive model for the Tessars only and special types for individual lenses, including one with rectangular aperture, corresponding with the Contax size, for the 1¹/₈-inch wide-angle Tessar



Fig. 28 Tilting Head



Fig. 29 Push-on Magnifier
for focussing-screen adapter

The telescopic lens-hood is for practically universal use. It is attached to the outer bayonet joint of the Contax and thus is not affected by the movement of the lens. Hence it can also be fitted with a rectangular aperture, affording specially excellent protection from reflection of

light into the lens. This hood is used at two extensions—fully drawn out for 2 inch Tessars and at two thirds of its full length for 2-inch Sonnars. Moreover the telescopic lens hood is well adapted for use with the telephoto lenses of $3\frac{3}{8}$, $5\frac{3}{8}$ and $7\frac{1}{8}$ ins focal length with aid of the connecting tube.



Fig. 30 Zeiss Ikon
Push-on Lens Hood

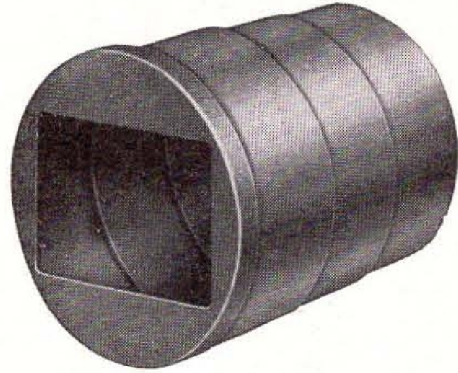

Fig. 31 Telescopic
Lens Hood

No good photographic outfit is complete without a *leather case* for effective protection from damage of the valuable optical parts and interchangeable lenses. A case of specially good two-part design is the Universal, which conveniently accommodates the Contax camera with standard lens, telephoto, filter, supplementary lenses, hoods, cassettes and film. It can be opened while slung from the shoulder without risk of any of the contents falling out.

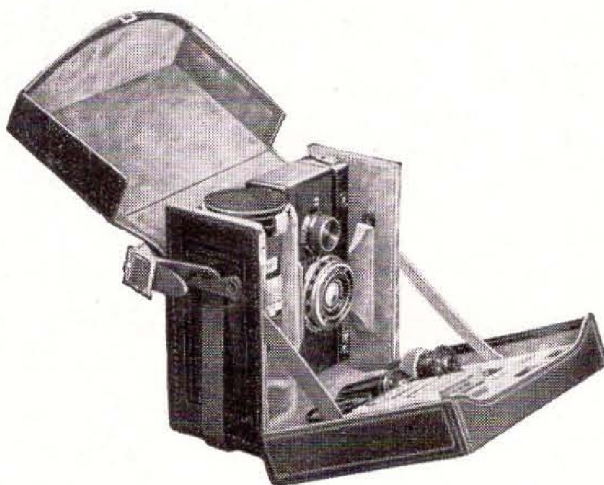

Fig. 32 Universal Case



Fig. 33 Lens Case

The entire contents are immediately accessible on opening the case.

For carrying separate telephoto lenses, there is a two part leather case, providing space for the lens in the lower part and for hood, filter and supplementary lens in the upper division.



Fig. 34 Contax in Ever-ready Case Fig. 35 Soft Leather Purse

A most handy case in which to carry the camera is that named the "Ever ready", as exposures can be made without taking the camera out—simply by opening the case. Those not wishing to carry a solid leather case should use a purse of soft doeskin for protection of the camera, which can be so carried by a strap from the shoulder. For keeping the negatives, and also contact prints from them, a very good practical *pocket album* has been designed complete with register and 120 envelopes, each holding a strip of six Contax negatives.

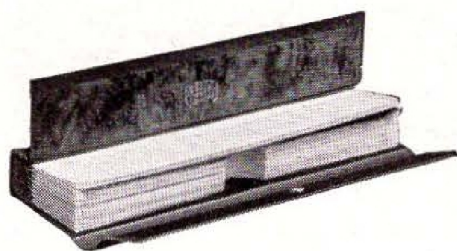
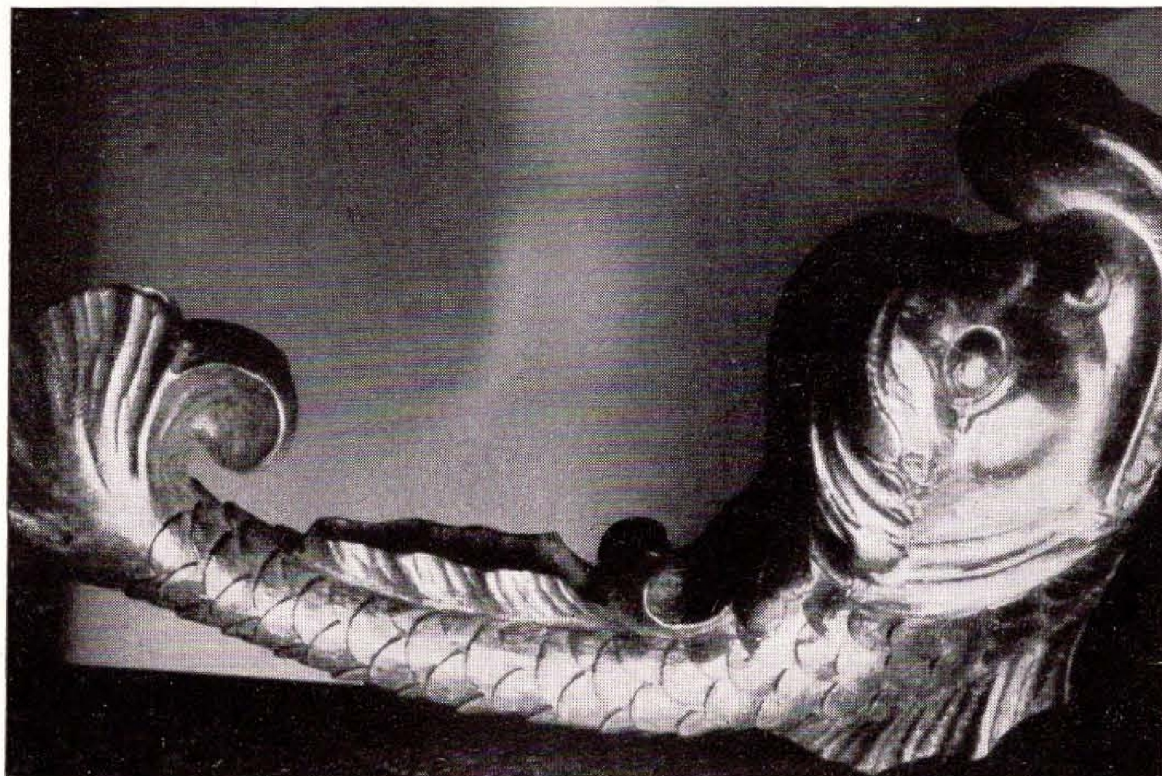

Fig. 36 Pocket Photo Album



BUTTERFLY

June in sun, 2-inch Zeiss Tessar $f/2.8$ at $f/8$
Proxar 2×27 . Exp. $\frac{1}{25}$ sec.



WOOD CARVING
Photo Kammerer

With Nitraphot lamp at $1\frac{1}{2}$ ft, 2-inch Zeiss Tessar $f/2.8$
at $f/11$; Proxar lens 2×27 at 15 ins distance. Exp. 1 sec.

Although the majority of Contax pictures are taken with the camera held in the hand, there are occasions, even for outdoor subjects, when a stand is wanted. The unipod is most convenient in such circumstances, and so also is the chain "stand", which is so small that it may be carried in the pocket. One advantage of the chain stand is that it can also be used to hold the camera at about table level, as most suitable for portraits.

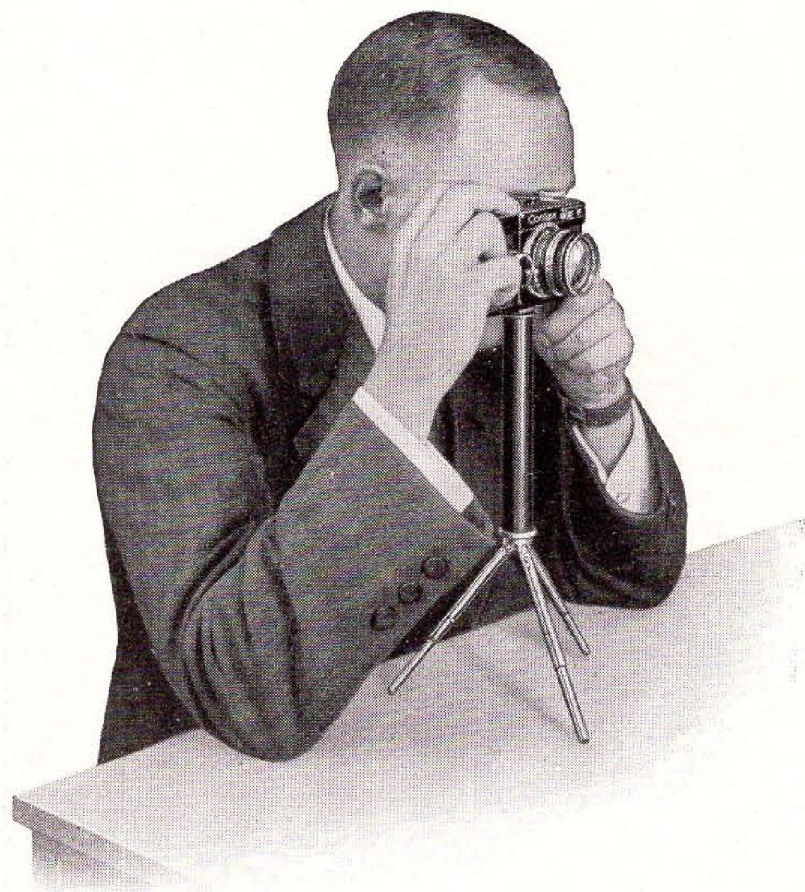

Fig. 38 Chain "Stand" used for low view-point

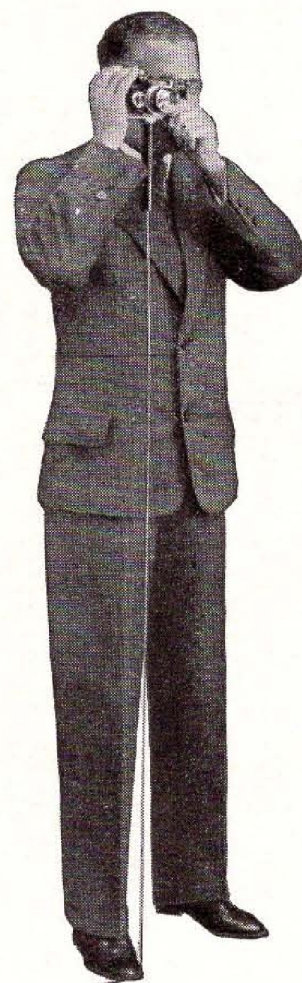

Fig. 37
Chain "Stand"

List of Articles of Part III

Dark-room Appliances

- No. 1839/8 Aladdin lamp, small model
No. 541/16 Template for cutting film
No. 5425/1 Contax developing tank, complete
No. 5425/2 Dish, only
No. 5425/3 Cover, only
No. 5425/4 Spiral plate, only
No. 5425/5 Cover plate, only
No. 3649 Developer ($1\frac{3}{4}$ ozs) for Contax Developing tank;
to make solution to fill tank

No. 2643/24 Lilliput II printing frame
No. 1538 Negative viewer with illuminating box, without
focussing magnifier and without lamp

No. 1290 Zeiss Ikon focussing magnifier
No. 1538/10 Adapting ring for same
No. 1292 Carl Zeiss focussing magnifier ($6\times$)
No. 1293 Carl Zeiss focussing magnifier ($16\times$)
No. 1538/11 Adapting ring for same
No. 1557 Lamps 15 watts, 110 volts, for negative viewer No. 1538
No. 1557/66 Lamps 15 watts, 220 volts, for negative viewer No. 1538
No. 2660/5 Printing box for 2×2 ins transparencies with
mask 24×36 mm

No. 2660 ditto for $2\frac{1}{4}\times 2\frac{1}{4}$ ins
No. 3525/6 Ten cover glasses 2×2 ins
No. 3525/4 ditto $2\frac{1}{4}\times 2\frac{1}{4}$ ins
No. 1593/9 Masks (100) 2×2 ins
No. 1593/6 ditto $2\frac{1}{4}\times 2\frac{1}{4}$ ins
No. 1601/2 Cleaning and binding appliance
No. 1601/1 ditto $2\frac{1}{4}\times 2\frac{1}{4}$ ins
No. 1608/2 Box to hold 50 transparencies 2×2 ins
No. 1608/1 ditto $2\frac{1}{4}\times 2\frac{1}{4}$ ins
No. 3114/4 Pocket photo album for keeping Contax posi-
tives and negatives in lengths of six pictures.
120 envelopes with register

No. 3097/5 Storage box for 50 negative wallets, without
wallets

Minor Accessories

- No. 1630/2 Tilting head
No. 5520/7 Push-on magnifier for focussing-screen adapter

Lens Hoods

- No. 1283/4 Tubular Lens Hood for 2-inch Tessars, $3\frac{3}{8}$ -inch Triotar $f/4$ and 7-inch Tele-Tessar K $f/6.3$
- No. 1283/3 Telescopic Lens Hood for Tessars and Sonnars of 2 ins focal length
- No. 1283/11 Adapting ring for use of Lens Hood No. 1283/3 on $3\frac{3}{8}$ -inch Triotar $f/4$, $5\frac{1}{4}$ -inch Sonnar $f/4$ and 7-inch Tele-Tessar K $f/6.3$
- No. 1283/1 Push-on Lens Hood for 2-inch Tessars, $3\frac{3}{8}$ -inch Triotar $f/4$, $5\frac{1}{4}$ -inch Sonnar $f/4$ and 7-inch Tele-Tessar K $f/6.3$
- No. 1283/2 Push-on Lens Hood for $1\frac{1}{8}$ -inch Tessar $f/8$
- No. 1281/4 Zeiss push-on Lens Hood
for lens diam, 27 mm
- No. 1281/8 ditto for lens diam, 37 mm
- No. 1281/9 ditto for lens diam, 42 mm
- No. 1281/10 ditto for lens diam, 51 mm
- No. 1283/5 ditto for $3\frac{3}{8}$ inch Sonnar $f/8.5$

Leather Cases

- No. 1777/5 Leather purse with quick-fastener for Contax with Tessar of 2 ins focal length
- No. 1777/10 Leather purse with quick-fastener for Contax with Sonnar of 2 ins focal length
- No. 1777/15 Twisted carrying strap for camera in leather purse
- No. 1777/3 Universal case for Contax with accessories
- No. 1777/6 Case for $3\frac{3}{8}$ -inch Triotar $f/4$ or $5\frac{1}{4}$ -inch Sonnar $f/4$ (State lens when ordering)
- No. 1777/7 Case for $3\frac{3}{8}$ -inch Sonnar $f/2$
- No. 1777/1 Solid leather case for Contax with 2-inch Sonnar
- No. 1777/2 Brown Ever-ready case for Contax with 2-inch Tessar
- No. 1777/8 Brown Ever-ready case for Contax with 2-inch Sonnar
- No. 1777/12 Box for Contax equipment

Stands

- No. 1624/10 Chain "stand"
- No. 1624/11 Unipod

Carl Zeiss Inc.
485 Fifth Avenue, New York
728 So. Hill Street, Los Angeles