

KODAK

RETINA IIIC
CAMERA

- You have purchased a truly fine camera. Utmost precision is combined with unsurpassed performance; the Retina tradition of quality and versatility is carried to new photographic heights.

The Retina IIIC Camera features — auxiliary interchangeable lenses — a coupled rangefinder combined with luminous, projected multiple-frame finder showing fields covered by 35, 50, and 80mm lenses—a built-in exposure meter — the Synchro-Compur shutter with exposure-value (light-value) settings and full flash synchronization—plus many other refinements that set a new standard for photography.

Before an important picture assignment, a trip, or any special event, shoot a roll or two of film and make a few flash pictures. This will give you practice and provide a check on your equipment.

Read the first section of these instructions (pages 3 to 13) carefully and practice the operations described without film in the camera—the controls work equally well with or without film. When you are familiar with this basic operation, then load your camera with film and take your first pictures; the sections which follow will give you further important information for successful pictures.

KODAK RETINA IIIC CAMERA

COUPLED RANGEFINDER and
VIEW-FRAME FINDER

EXPOSURE METER

SYNCHRO-COMPUR SHUTTER

INTERCHANGEABLE LENSES

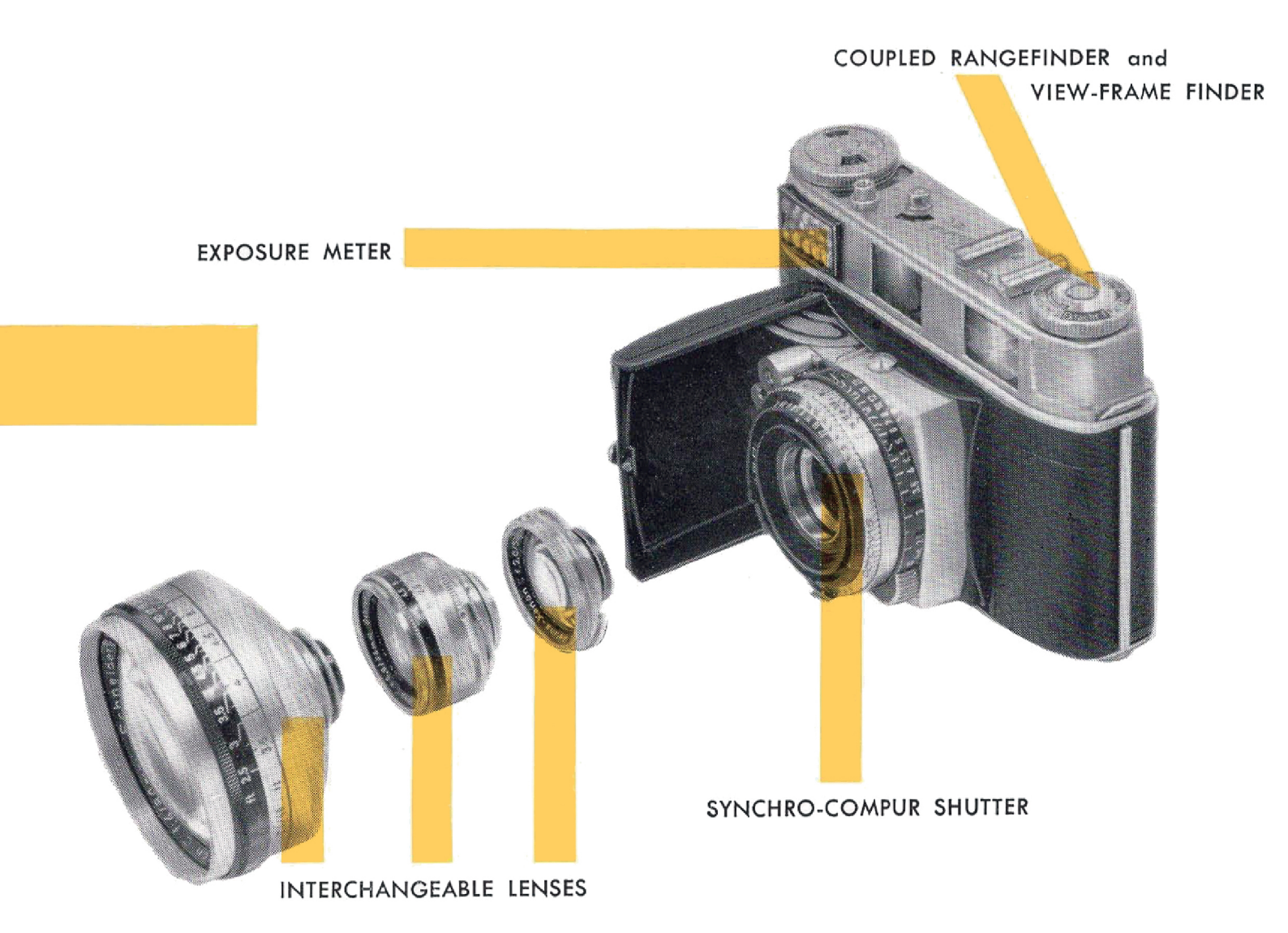

OPENING BUTTON

COVER



opening

Hold the camera in your hand and press the **OPENING BUTTON** toward the word "Kodak"; at the same time pull open the protective **COVER** carefully until the shutter panel locks in position.

closing

Move the **FOCUSING KNOB** down as far as it will go to set the focusing scale to "inf." The closing buttons cannot be depressed until this is done. Simultaneously press the two **CLOSING BUTTONS** on each side of the shutter panel; then close the cover.

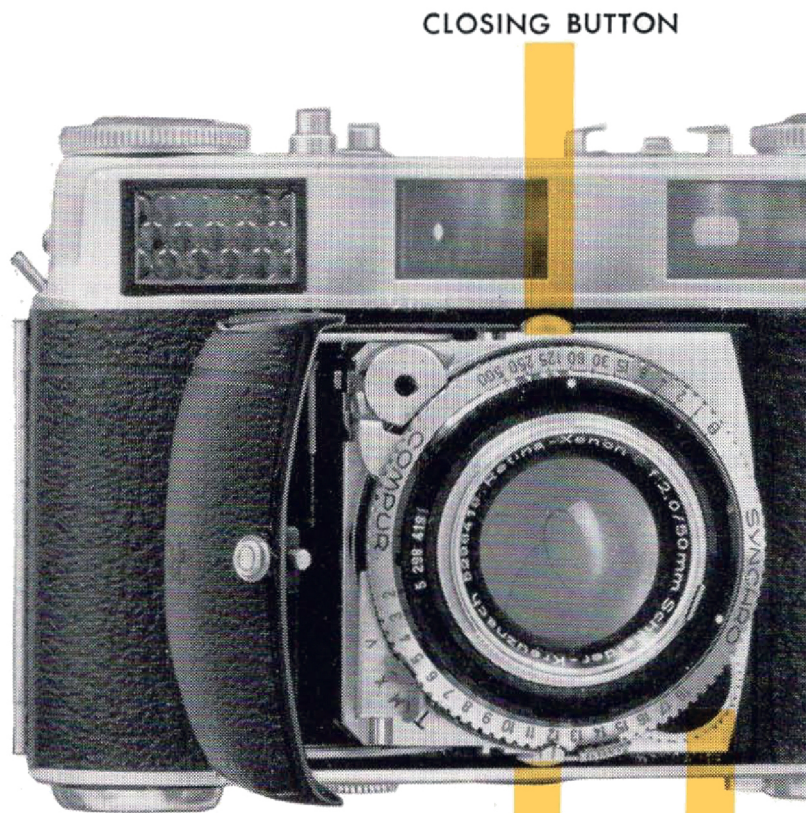

CLOSING BUTTON

CLOSING BUTTON

FOCUSING KNOB

sighting the camera



Grip the camera with both hands and look through the eyepiece. Hold the camera at that distance from the eye which allows you to frame the subject in that view frame of the finder which corresponds to the lens mounted on the camera. Frame the subject in the middle (bold) frame with the standard (50mm) lens; in the center (smallest) frame with the telephoto (80mm) lens; and in the outside (largest) frame with the wide-angle (35mm) lens.

The horizontal indicators near the top and on both sides of each view frame provide for parallax

The illustrations at the right, showing the positions for horizontal and vertical pictures, are intended as a guide for holding the camera steady; other positions, of course, are possible. Try a few positions to see which is best.

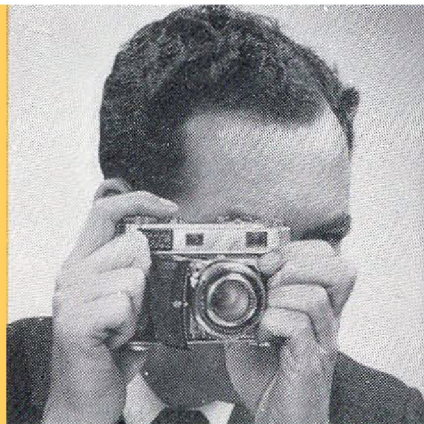



correction at close distances. Therefore, when the camera is focused for distances from 6 feet to the minimum focusing distance, the indicators show the upper edge of the picture when the camera is held horizontally. The part thus eliminated at the top of the frame is added to the bottom.*

focusing

Hold the camera in the picture-taking position and look through the eyepiece. You will see the subject outlined by one of the luminous view frames. In the center of the field of view you will also notice the rangefinder field in the form of a round spot. Until the camera is focused for the correct distance, this field shows a double image of the subject. To set the distance correctly turn the focusing knob (shown on page 3) until the outlines of the double image move together and coincide, so that only one image is visible. The lens is now set for the film plane†-to-subject distance.

*The four vertical pointers, two on the base and two on the top of the 50mm frame, indicate the boundaries for pictures with the Stereo Attachment.

†The film plane location corresponds to the rear top edge of the camera.

determining exposure

NEEDLE

PHOTOCELL



INCIDENT LIGHT MASK

INDEX

POINTER

SETTING RING

Set Film Index in ASA window by turning the inner disc by means of the button as described on page 20.

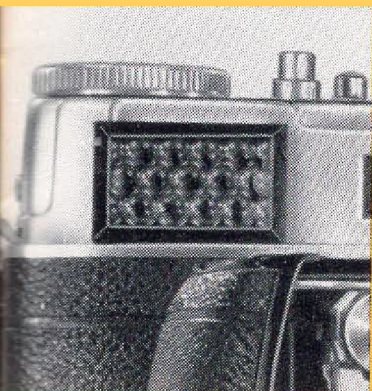

Make sure that the honeycomb cells of the exposure meter are not obstructed by fingers, strap, or any other object when making a reading.

The Retina IIIC has a built-in photoelectric exposure meter which, when the camera is pointed toward the subject, measures light reflected from the subject. This provides a guide to the correct exposure-value (light-value) settings. The exposure value is a number corresponding to the amount of light required for correct exposure.

Determine the exposure value from the exposure meter as follows:

1. For readings taken from the camera position, remove the white Incident Light Mask from the front of the PHOTOCELL by sliding the mask upward and lifting it off. (Replace the mask for Incident Light readings. This method is described on page 38.)
2. Point the camera at the subject, directing it slightly downward; the white NEEDLE will move in the window.
3. Turn the meter SETTING RING to move the yellow POINTER directly over the white needle.
4. Read the exposure-value number on the setting ring opposite the INDEX.

EXPOSURE-VALUE LEVER

LENS OPENING SCALE

SPEED RING

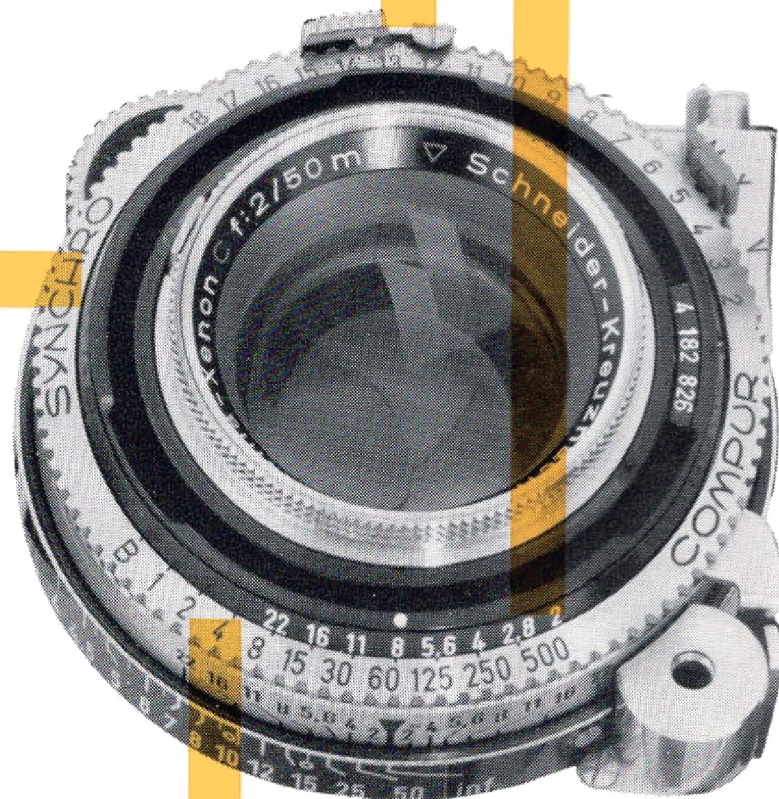

SHUTTER SPEED SCALE

On the shutter SPEED RING you will find the same scale of exposure values, from 2 to 18, that is engraved in red on the exposure meter setting ring. Now transfer the exposure value read off the setting ring of the exposure meter to the shutter speed ring. To do this, pull the EXPOSURE-VALUE LEVER slightly outward and move it until the pointer is at the appropriate number on the scale of the ring. If you cannot move the lever to the desired number because the lever reaches the limits of its travel, turn the shutter speed ring until the appropriate exposure value is available. You can set in-between exposure values if the meter setting ring gives an intermediate reading.

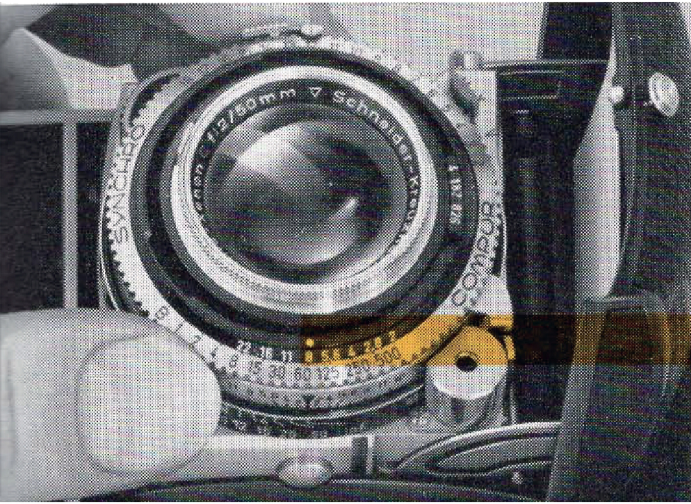

The shutter speed and lens opening (coupled by the exposure-value setting) can now be read opposite the white dot INDEX. For example: with an exposure value of 12 the camera may be set for a combination of lens opening $f/8$ and $1/60$ second. Suppose this combination is not suitable for your subject because you need a faster shutter speed, such as $1/500$ second, for a sports shot. In that case, turn the shutter speed ring, from $1/60$ to $1/500$ second. This automatically adjusts the lens opening to $f/2.8$ and thus compensates for the faster shutter speed time.

On the other hand, if you intend to take a picture which calls for good depth of field, for example, needing a lens opening such as $f/16$, you must rotate the speed ring in the same manner until the figure 16 on the LENS OPENING SCALE is opposite the white dot index. This changes the shutter speed to $1/15$ second. Such an exposure should, however, only be made from a firm support, for there is risk of camera movement at exposure times of $1/30$ second or longer.

summary of steps

After setting the film index in the ASA window, as described on page 20,

1. Point the exposure meter at the subject.
2. Turn the meter setting ring to make the yellow pointer coincide with the white needle of the meter.
3. Read the exposure value.
4. Set the exposure value on the shutter speed ring by means of the exposure-value lever.
5. If necessary, alter the lens opening-shutter speed combination by simply turning the speed setting ring.

Make sure the exposure-value lever is not accidentally shifted from the set exposure value.

11

1

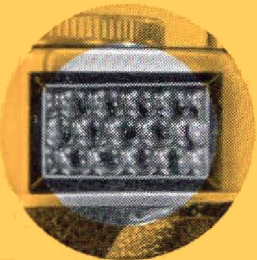

2



3



4

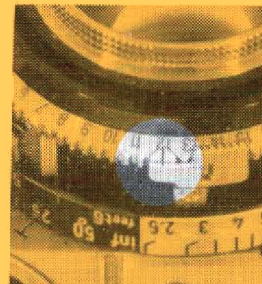

5

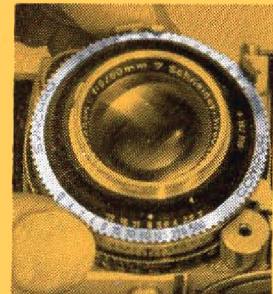

setting and releasing shutter

Look through the finder eyepiece; sight the subject, and press the EXPOSURE RELEASE. If the shutter is not set, you cannot press the button.

To set the shutter, with the right thumb swing out the RAPID WIND LEVER in one movement *as far as it will go*; then let it return to its original position. If it does not return, you did not swing it out far enough. Winding this lever, at the same time sets the shutter and—if you have film in the camera—advances the film by one frame and advances the film counter (page 18). Now you can press the exposure release. You will notice how smoothly the release operates; this is important to avoid camera movement.

12

CAUTION: Make sure that you press the larger button pointed out in the illustration.



RAPID WIND LEVER

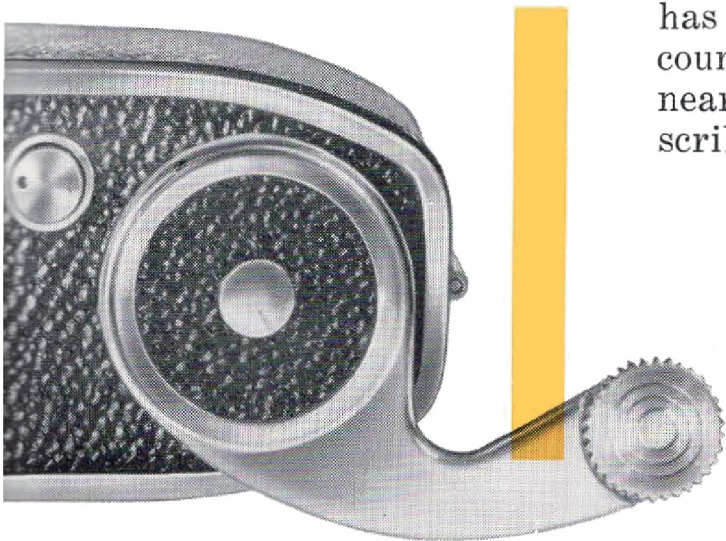

If during this practice operation, the rapid wind lever becomes locked, this means either that the exposure release has not been pressed, or that the film counter is at "1" and must be reset to the nearest diamond-shaped mark as described on page 18.

13

You are, by now, familiar with the "feel" of your camera and the most important points of camera operation. So, let's select a film from the following pages, load the camera, and take a roll of pictures. If you wish to start off with black-and-white pictures, you might choose a general-purpose film such as Kodak Plus-X; however, inasmuch as your camera is so perfectly suited as a "color camera," you may wish to load immediately with Kodachrome or Kodak Ektachrome Film for pictures in full color.

films

The Kodak Retina IIIC Camera uses Kodak 135 Film

COLOR FILMS

Kodachrome Film — For full-color transparencies which can be projected on a screen or from which prints or enlargements can be made.

Use Kodachrome Film for Daylight for daylight pictures, and Kodachrome Type F for flash or flood-lighted pictures. 20 or 36 exposures.

Kodak Ektachrome Film — Like Kodachrome, Ektachrome Film produces life-like color transparencies for projection or from which color prints and enlargements can be made. The speed of this film, however, is faster than that of Kodachrome Film. You can process this film yourself or have it processed by your photofinisher.

Use Kodak Ektachrome Film for Daylight for exposure in daylight, and Kodak Ektachrome Film Type F for pictures with clear flash lamps. 20 exposures.

BLACK-AND-WHITE FILMS

Kodak Panatomic-X Panchromatic Film—The film to use for big enlargements when high film speed is not a factor. It combines exceptionally fine grain and the ability to record extremely fine detail. 20 or 36 exposures.

Kodak Plus-X Panchromatic Film—An excellent high-speed film for general outdoor and interior use. The low graininess and high resolving power permit high-quality enlargements. 20 or 36 exposures.

Kodak Tri-X Film—An extremely fast panchromatic film of moderate contrast, wide exposure and development latitude, and color sensitivity suitable for all types of indoor and outdoor illumination. 20 or 36 exposures.

KODAK FILMS

	FILM INDEX	
	Daylight	Photoflood
Kodachrome (Daylight)	10	5*
Kodachrome (Type F)	10**	10†
Ektachrome (Daylight)	32	12*
Ektachrome (Type F)	20**	16†
Panatomic-X	25	20
Plus-X	80	64
Tri-X	200	160

*With Kodak Photoflood Filter No. 80B (for Kodak Daylight Type Color Films)

**With Kodak Daylight Filter for Type F Color Films (85C)

†With photographic flood lamps and Kodak Wratten Filter No. 82A

NOTE: Film index numbers are intended as a guide for setting correct exposure values.

loading

in subdued light

- 1** To open the back of the camera, press the **MILLED LEVER** clockwise; the opposite end of the lever then uncovers the opening **BUTTON**. Press this button and the back springs open.
- 2** Pull the **REWIND KNOB** out to the second stop.
- 3** Turn the built-in **TAKE-UP SPOOL** by its flange until a slot points upward.
- 4** With the lower edge of the film against the lower take-up spool flange, push the trimmed end of the film protruding from the magazine far enough into this slot to anchor a perforation over the small pin of the slot.
- 5** Pull the film over the film track and insert the magazine in the **SUPPLY CHAMBER**. Push in the rewind knob (turn slightly if necessary). Then

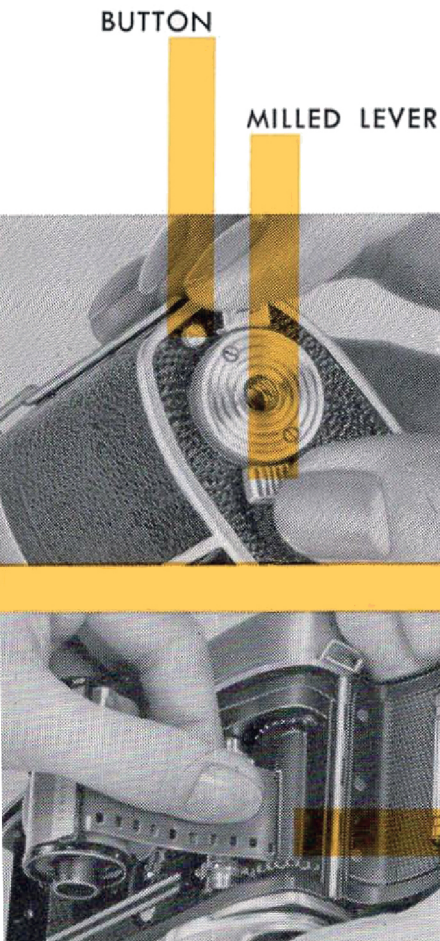

TAKE-UP SPOOL

REWIND KNOB

SPROCKET TEETH

SUPPLY
CHAMBER

TAKE-UP
SPOOL

SPROCKET TEETH

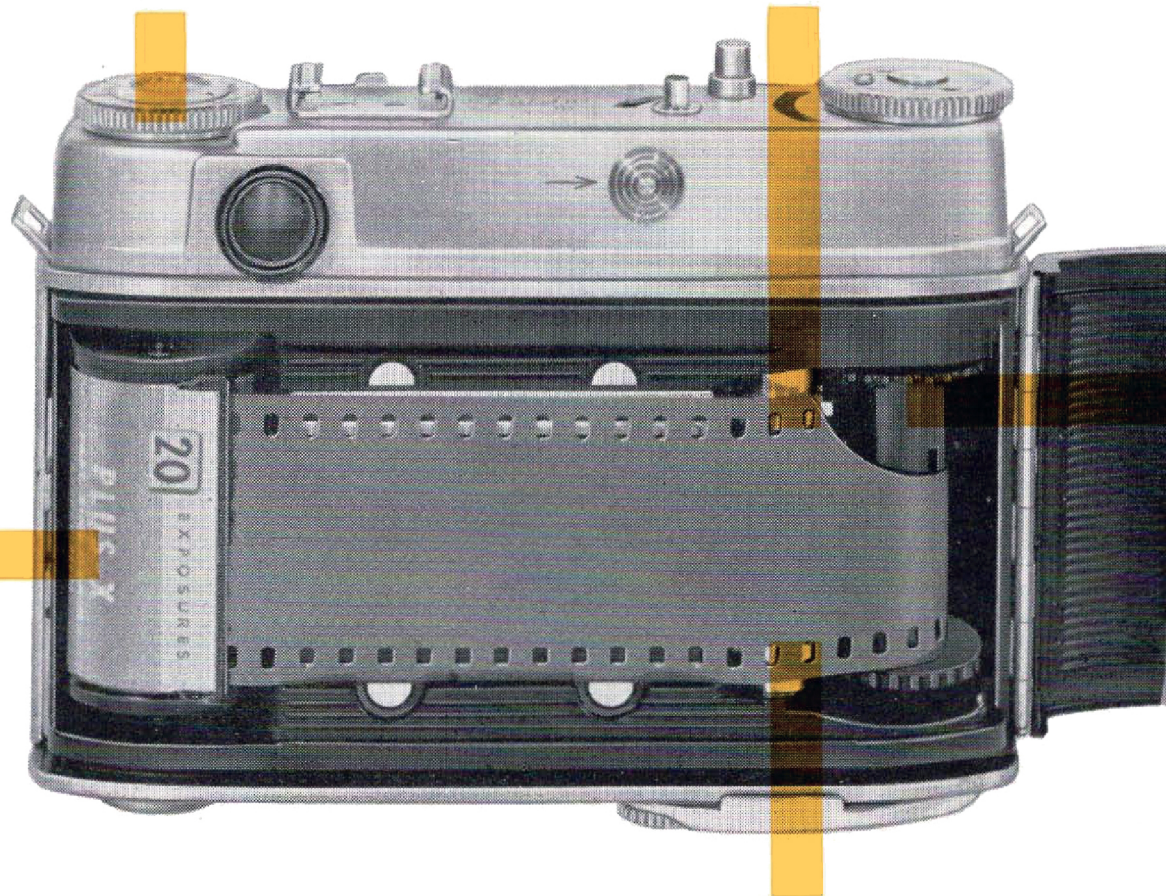

THE FILM INDICATOR: Set the type of film loaded in the camera on the film indicator located on top of the rewind knob. Grip the rewind knob with two fingers and turn the inner ring with the thumb of the other hand until the triangular index points to the type of film loaded in the camera.

turn the take-up spool by its flange until the **SPROCKET TEETH** engage the perforations *on both sides* (shown on previous page).

- 6 After making sure that the sprocket teeth engage the film perforations on both sides, close the back of the camera, by pressing the back against the body until it locks.

setting the film counter

Depress fully and hold down the **FILM RELEASE** button (within the curved guard); then, at the same time, press the **FILM COUNTER ADVANCE** in the direction of the arrow as many times as necessary to bring the diamond-shaped mark near 36 on the **FILM COUNTER** opposite the notch. If you are using a 20-exposure magazine, set to the diamond-shaped mark between 20 and 25. Press and release the film release button; then swing out and release the rapid wind lever. Do this 2 more times to bring

the film counter to 36 or 20, depending on the number of exposures in your magazine.

The film counter always indicates the number of exposures still available. After making exposure 1, a transport lock comes into operation; neither the rapid wind lever nor the exposure release will then operate. This prevents the film end from being pulled from the magazine.

NOTE: When the rapid wind lever is swung out, the rewind knob should turn counterclockwise (after slack has been taken up in the magazine). This will provide a check on whether or not film is advancing properly.

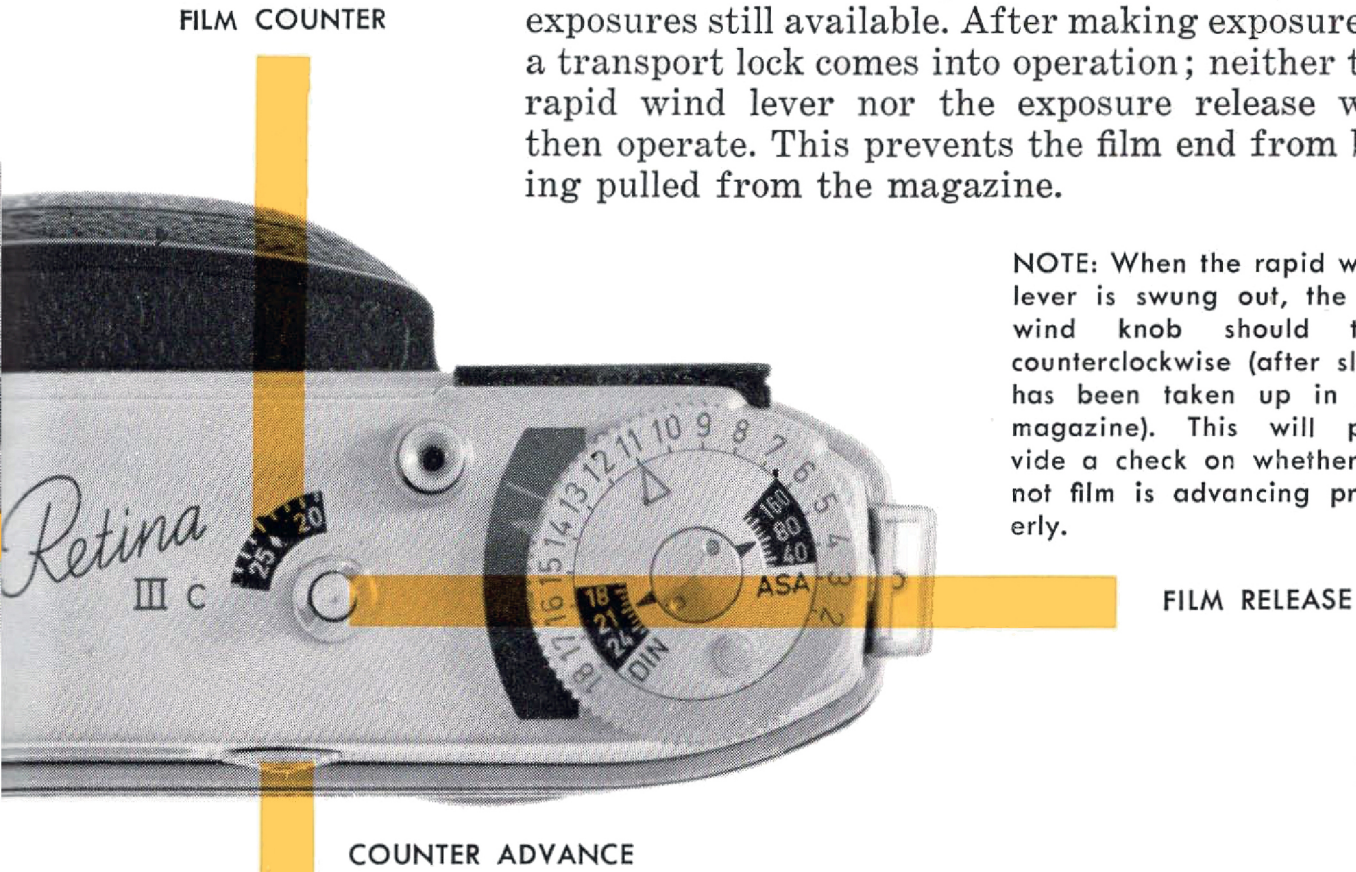

FILM COUNTER

FILM RELEASE

COUNTER ADVANCE

setting the film index

The film index of the film loaded in the camera can be found in the instructions packed with the film and on page 15. Turn the INNER DISC of the exposure setting ring by means of the BUTTON until the appropriate film index of the film in the camera appears in the ASA WINDOW*. For example: The daylight index of Kodak Plus-X Film is 80; for this film used in daylight, set 80 in the window. The daylight index of Kodachrome Film for Daylight is 10; set 10 in the window for daylight exposure of this film. The window marked DIN should be ignored.

Check occasionally to make sure that the film index has not been accidentally shifted. For modifying film index settings, see pages 34 to 39.

*Make sure that the ASA window is always in position to cover the ASA scale of numbers from 5 to 1300, as shown in the illustration.

INNER DISC

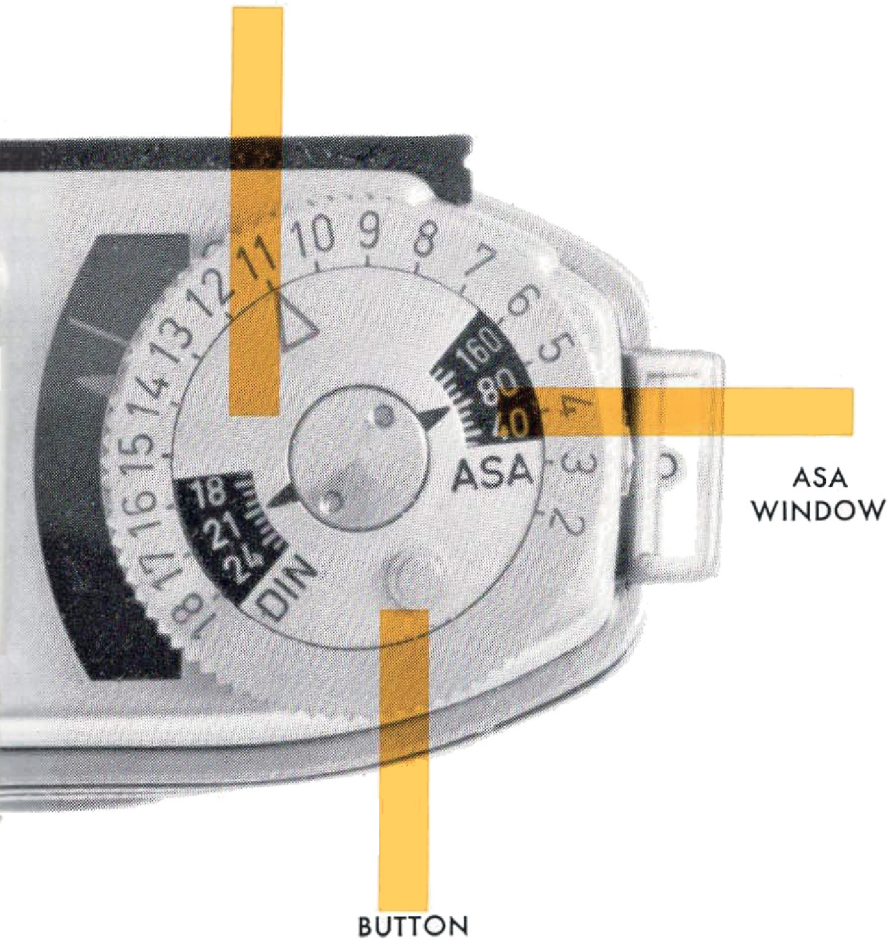

ASA
WINDOW

BUTTON

unloading

Always Unload in Subdued Light

To rewind the exposed film, depress the **CLUTCH BUTTON** in the base of the camera and pull the rewind knob straight out until you feel resistance (about a quarter inch). Then turn the rewind knob in the direction of the arrow until the clutch button ceases to rotate; this is easily observed by the small black dot near the rim of the button. The film is now rewound into the magazine; open the camera back, pull out the rewind knob all the way, and remove the magazine.

CLUTCH BUTTON

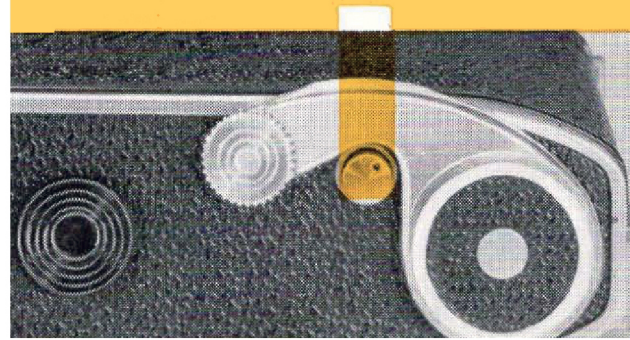

setting the focusing scale

In addition to using the coupled rangefinder to determine distance automatically, you can also set the FOCUSING SCALE (for 50mm lens) manually for film plane-to-subject distance. Set the correct film plane-to-subject distance on the focusing scale opposite the FOCUSING INDEX.

The small red dot next to the focusing index is to be used instead of the focusing index when focusing with Infrared Film. Therefore, turn the focusing knob until the figure corresponding to the film plane-to-subject distance is opposite the red dot when using infrared film.

The bottom of the focusing ring carries three other scales. These are for use with the interchangeable lenses which are described on page 28.

depth of field

After you have properly focused on your subject, the subject will be sharp in the picture. However,

other objects in the picture area, both in front of and behind the subject, will also be in focus. This is “range of sharpness” or “depth of field.”

To permit instant reading of the depth of field for any lens opening and distance, a DEPTH-OF-FIELD SCALE composed of numbers corresponding to lens openings is arranged on either side of the focusing index.

Suppose you have set the aperture to $f/8$ and the distance to about 9 feet; this is how you read off the depth: To the left of the focusing index the line marked with the figure 8 (corresponding to the lens opening) is opposite 6 feet. To the right of the index another line marked with the figure 8 points to 16 feet. This tells you that with a setting of about 9 feet at $f/8$ you have a depth-of-field zone extending from about 6 to 16 feet. Within this zone everything will be sharp.

23

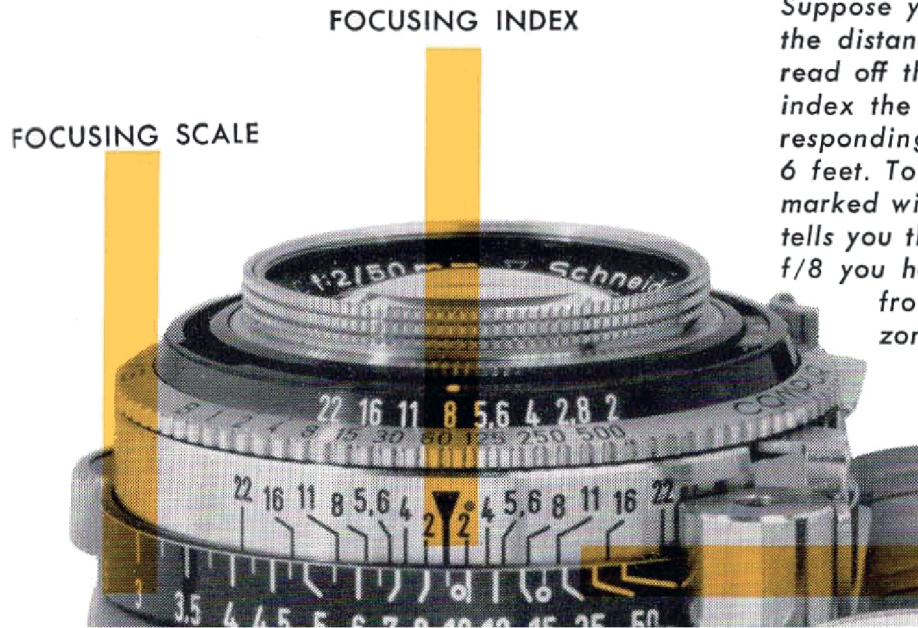

DEPTH-OF-FIELD SCALE

zone focusing

Technically good exposures depend largely on the skilled combination of correct distance, shutter speed, and lens opening settings. However, you may encounter subjects where you just haven't the time to work out the ideal setting or to use the rangefinder, if you don't want to miss the picture. For such occasions your camera carries two zone focus settings: one for near and one for distant subjects. With these settings you must, however, have adequate light.

For near subjects set the distance to the small circle near the 10-foot mark, and the lens opening to $f/8$. This gives you a depth of field from about 6 to 20 feet.

For more distant subjects use the small circle near the 15-foot mark and an aperture of $f/8$. This gives a depth of field from about 9 feet to inf.

flash pictures

- Flash pictures, in black-and-white or color, are easy to make with your camera. The built-in synchronization of your Synchro-Compur shutter permits the use of flash, including electronic flash. Flash lamps are fired when the camera shutter is released.

Either the Kodalite Super-M 40 Flashholder or the Kodak Rotary Flashholder, Type 1, with Kodak Retina Flashholder Bracket is recommended for use with your camera. The B-C (battery-condenser) method* of flashing lamps provides powerful electrical energy for accurate synchronization and offers more dependable lamp firing.

The versatile, compact Kodalite Super-M 40 Flashholder is supplied with interchangeable 3-inch and 4-inch re-

*Supplied with the Rotary Flashholder, and available for the Kodalite Super-M 40 Flashholder.



Kodalite
Super-M
40 Flashholder
mounted to
Kodak Retina
Flashholder
Bracket



Kodak Rotary
Flashholder, Type 1
mounted to
Kodak Retina
Flashholder Bracket

flectors for greatest efficiency with M-2 lamps and No. 5 or No. 25 lamps.

The Kodak Rotary Flashholder, Type 1 features rapid sequence lamp-firing. Six M-2 lamps are preloaded in the magazine and advanced, one at a time, to firing position by rotating the turret.

synchronization • speed settings

There are three letters engraved on the block of the flashpost; M and X are synchronizer settings for flash, V is the self-timer setting. These settings are adjusted by the SELECTOR lever (illustrated on opposite page).

M-2 Lamps—Set the synchronizer selector pointer on X (pointer in illustration is set at M). Set the shutter at 1 to 1/30 second. Consult the calculator on the flashholder for exposure information.

Lamps, such as No. 5 or No. 25—With the synchronizer selector pointer on M, exposures can be made from 1 second to 1/500 second.

Electronic Flash—Set the synchronizer selector pointer on X. With electronic flash equipment having no lag in the trip circuit, set the shutter at any speed from 1 second to 1/500 second.

Note: Do not use units flashed by means of heavy-duty relays or solenoids. Such units may destroy the shutter contacts.

THE SELF-TIMER—If you wish to include yourself in a picture, first operate the rapid wind lever; then set the selector pointer to V. Start the self-timer mechanism by pressing the exposure release*. The shutter will go off after about 10 seconds — time to take your place in the picture.

If you use the self-timer for flash shots, the camera works with the X-synchronization. As the self-timer runs down, the synchronizing lever automatically moves to X. Be sure to use the correct shutter speed setting for X-synchronization. No. 5, No. 25 or No. 8 lamps can be used at X selector setting for speeds from 1 to 1/30 second.

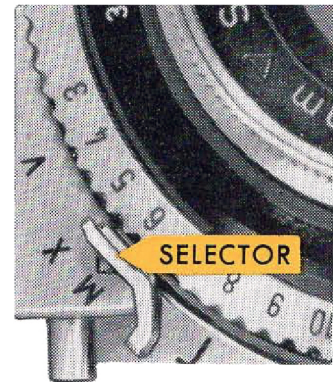

*After moving the selector lever to "V," it must be returned by making an exposure. Do not force the lever.

auxiliary interchangeable lenses

An 80mm long-focus lens component, especially suited to portraits and long-range subjects, and a choice of two 35mm wide-angle lens components, particularly useful when you wish to cover a wide subject field, are available to widen the scope of your Retina IIIC Camera. The view finder of the camera shows the field of view for both the 35 and 80mm lenses.

The standard lens of your camera is the 6-element, $f/2$, 50mm, Kodak Retina-Xenon C Lens. When the front component of this lens is removed to admit one of the auxiliary lenses, the shutter blades are exposed. Behind the blades is the rear lens component. This forms a complete lens only in combination with the standard, telephoto, or wide-angle lens components specified for this camera. *Change lenses in subdued light.*

The front component of the standard lens

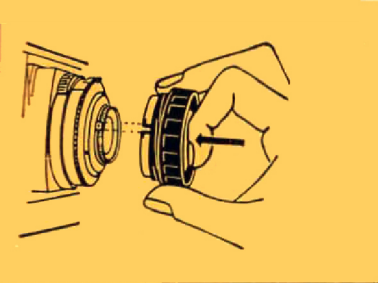
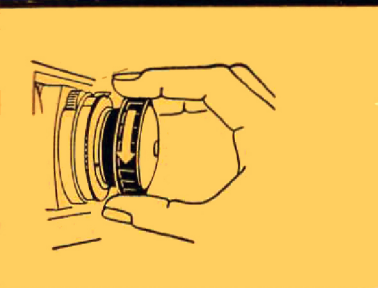
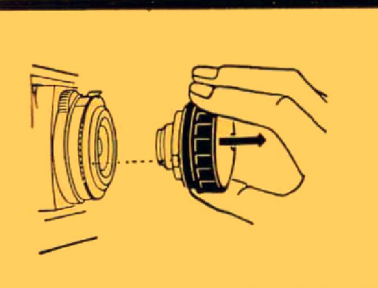
**1****2****3****4**

is locked in place by a bayonet-type, internal snap-lock mechanism. For removal and storage of the front component, the use of the Kodak Retina 50mm Lens Component Case, a special grip-top container, is recommended. As shown in the illustration, after removing the top of the case, (1) press in the transparent center of the top to bring the grip-insert to its full-open position. (2) Place the insert over the lens rim with the red dot showing in one of the three slots. Press the black outer ring toward the lens as far as it will go to tighten the hold of the grip-insert; then turn counterclockwise. (3) Remove the lens, tilting the camera downward. (4) Place the bottom of the container over the lens while it is held in the grip-top, engage the threads of the top and bottom of the container, and tighten. The lens can be replaced on the camera by placing the red dot on the lens flange opposite the red dot on the lens opening ring and turning the lens clockwise until the snap lock engages (red dot lines up with white dot). *Make sure that these two dots remain lined up.*

telephoto shots

Telephoto effects can be obtained with the Kodak Retina Longar Lens Component, 80mm $f/4$ (for Kodak Retina Cameras with Xenon C Lenses). To attach the lens to the camera, place the red dot exactly opposite the red dot (arrow in illustration) on the lens opening ring; then press in and turn the lens clockwise until the snap lock engages (red dot lines up with white dot).

The rangefinder can be used to focus not only the 50mm lens, but also the 80mm or 35mm lens.

To focus the Longar lens, determine the camera-to-subject distance with the camera rangefinder, and note the distance figure opposite the index on the focusing scale for the standard 50mm lens. Now, tilt the camera up and look underneath the shutter to find the TELE-SCALE. Then transfer the measured value to the part of the tele-scale marked with chrome figures on black. To do this, turn the focusing knob until the measured distance on the tele-scale is opposite the "T" INDEX mark.



By attaching a Kodak Retina 80mm Auxiliary Lens (for Kodak Retina Longar Lens Component, 80mm $f/4$) to your telephoto lens, you can also focus the telephoto lens with the rangefinder for distances from 6 feet to 3.5 feet. In that case, transfer the measured distance to the part of the tele-scale with the gold figures on black.

31



"T" INDEX

TELE-SCALE

The rotating ring on the telephoto lens is for indicating depth of field only; the camera cannot be focused with this ring. The distance scale of the ring is engraved in the same colors as the tele-scale as a reminder to set the appropriate scale for correct focus.

CAUTION: Remember that the largest lens opening of your Longar lens is $f/4$. Therefore, when moving the speed ring, make sure that the white dot index does not indicate a larger lens opening than $f/4$; that is, $f/2$ or $f/2.8$. Otherwise the picture will be underexposed.

Make sure that the component lens is securely seated at all times.

CAUTION: Keep in mind the largest lens opening of your Curtar lens. When moving the speed ring, make sure that the white dot index does not indicate a larger lens opening than $f/5.6$ or $f/4$, depending on which lens is in use. Otherwise the picture will be underexposed. Make sure that the component lens is securely seated at all times.

wide-angle shots

For wide-angle effects with your camera, use the Kodak Retina Curtar Lens Component, 35mm $f/5.6$ or $f/4$ (for Kodak Retina Cameras with Xenon C Lenses). To attach the lens to the camera, place the red dot opposite the red dot on the lens opening ring; then press in and turn the lens clockwise until the snap lock engages (red dot lines up with white dot).

To focus the Curtar lens correctly, get the camera-to-subject distance with the rangefinder and note the distance figure opposite the index on the focusing scale for the standard lens. Now, transfer the distance figure obtained with the rangefinder to the WIDE-ANGLE SCALE (black figures on chrome) by turning the focusing knob to bring the appropriate figure to the triangular WIDE-ANGLE INDEX.

Like the telephoto lens, the wide-angle lens carries a color-keyed scale for indicating depth of field *only*.

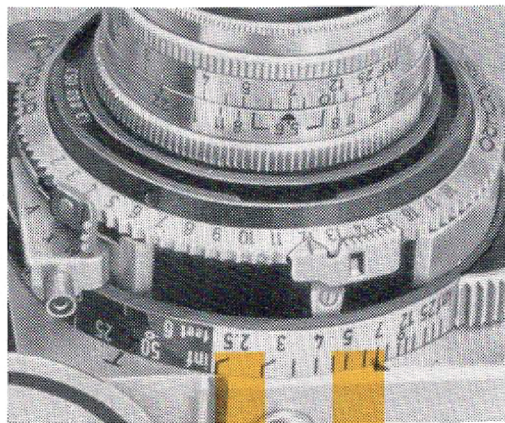

32

WIDE-ANGLE SCALE

WIDE-ANGLE INDEX

setting exposures

**without
exposure values**

Shutter speeds and lens openings can also be set without reference to exposure values. However, the *shutter speed must be set first* and the lens opening after. Otherwise, the lens opening will be changed because of the speed ring coupling.

time exposures

If a subject needs a longer exposure time than one second, make a time exposure. Simply mount the camera on a tripod or other firm support and make an exposure* for the desired time, with the shutter set at B.

Set the lens opening; then press the exposure release for the correct interval; the shutter is open while the exposure release is depressed.

*The Kodak Metal Cable Release No. 5 screws into the top of the exposure release. The camera should be mounted on a tripod or other firm support for all exposure times longer than 1/30 second.

exposure meter

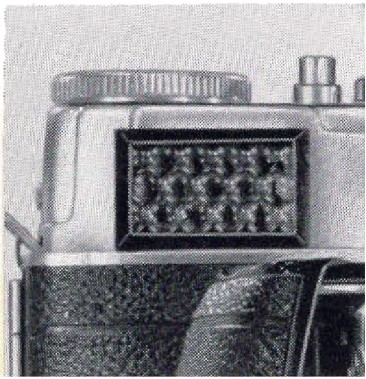

Reflected Light Readings. The exposure meter of the Retina IIIC is primarily used for measuring the intensity of light *reflected by the subject*.

With the Incident Light Mask removed from the exposure meter, point the camera at the subject as described on page 7.

The field covered by the exposure meter is about the same as the field covered by the 50mm lens.

The meter reads the average over-all brightness of the field covered. If the field is evenly illumi-

34

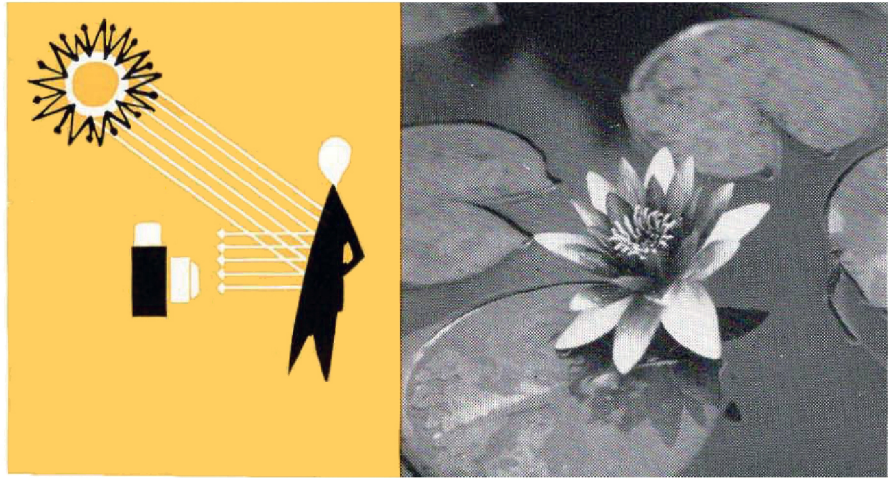

NOTE: When using the telephoto or the wide-angle lens, keep in mind that the former covers a smaller field, and the latter, a larger field than the exposure meter. Watch for brightness differences between the field covered by the lens and the exposure meter, which may influence the meter.

nated (see illustration, page 34) and lacks great contrast, the exposure-value number provided by the meter can be used without modifications. This applies also when the highlight and the shadow areas are of about the same size and of equal interest value. This is especially the case with black-and-white film due to its great exposure latitude.

Under certain conditions, better exposure is obtained by modifying the use of the exposure meter. This is particularly so with color films due to their relatively limited exposure latitude. For example, when determining the proper exposure for a person in light-colored clothing occupying approximately half of the field, against a dark background — the exposure meter, reading the over-all brightness, will give an exposure value which will result in overexposure of the person.

To obtain a better exposure of the subject of principal interest, do the following:

1. Step close to the person, and take a reading of the light reflected by the subject only (see illustration on next page), or . . .

2. Increase the exposure-value number by one-half (for example, from 8 to between 8 and 9), if the difference in brightness between the principal subject and background is moderate, and one full exposure-value number if the difference is considerable.

If the principal subject is dark compared to the background, follow the same general procedure — Take a close-up reading of the subject—or *decrease* the exposure value by one-half or one full number depending upon the brightness difference between the principal part and background.

36

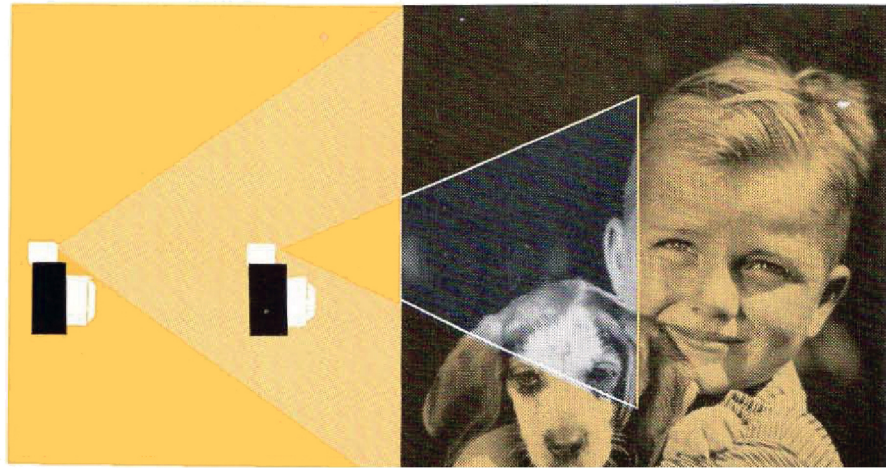

The film indexes for color films, assigned by the manufacturer, can be used with meters marked for ASA Indexes. However, it may be desirable to modify this index to get the result you want for the condition under which you will use the picture. For example, a transparency projected with a high-wattage projector on a small screen requires less exposure than when shown with a low-wattage projector on a large screen.

If you have taken pictures before, be guided by past experience. Note the reading provided by the meter and, if necessary, adjust the index.

With color film it may be worth while to take a few pictures of a typical sunlit outdoor subject, with the sun in back of you, for test purposes. One picture should be at the setting indicated by the exposure meter and the others one exposure-value number more and one exposure value less. From the results, when projected, you can tell readily whether you should use the setting suggested by the film manufacturer or a higher or a lower one.

Another approach to getting the kind of pictures



Storage for the incident light mask is provided in the top of the field case.

38

you want is to use the exposure meter as recommended, and note whether the slides are correctly exposed, too light, or too dark. If they tend to be light, try a higher film index; for example, if "10" is the film index suggested by the manufacturer, try a setting between 10 and 20.

Incident Light Readings. There are instances where measurement of the light *falling on the subject* must be used (see illustrations below).

Place the Incident Light Mask over the front of the exposure meter by sliding it down from the top. Point the camera from the subject to the posi-

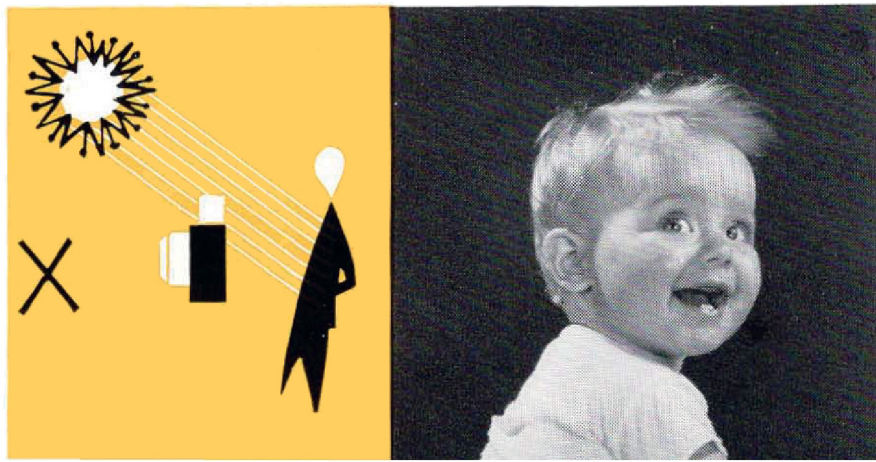

tion from which the picture will be made (X in illustration). The same scales are used as with reflected light readings.

This method is recommended for floodlighted subjects indoors, or when taking pictures against the light, close-ups such as a white face against a large black background, and snow scenes.

When the subject itself is inaccessible, successful readings can be taken from a substitute position which is illuminated similarly to the subject.

the film release

The FILM RELEASE button can be used to deal with any blockage of the rapid wind lever that may occur. Just depress the film release button (within its curved guard) fully; if the lever is locked between the start and end of its swing, it will spring back into place.

A close-up photograph of the top of a vintage camera, showing the ASA and DIN scales and the film release button. The ASA scale is a circular dial with numbers 1 through 18. The DIN scale is a curved guard with numbers 1 through 18. The film release button is a small circular button with a yellow highlight. The camera body is silver and has the word "Astina" and "III C" visible.

FILM RELEASE

multiple exposures

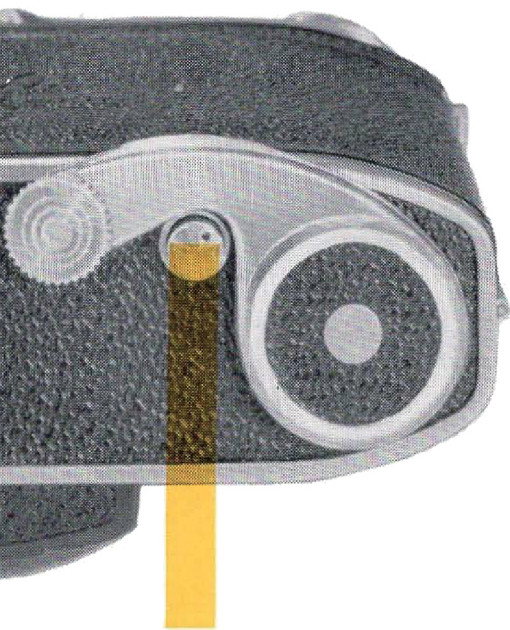

CLUTCH BUTTON

To take an intentional multiple exposure, first make the original exposure; then *press and hold* the CLUTCH BUTTON *while operating* the rapid wind lever. Pressing this button disengages the film advance mechanism but permits the operation of the rapid wind lever to set the shutter. (Use this method also for saving film if flash lamps fail to fire.)

Inasmuch as the film counter is also advanced, one or more frames of film will be available than is shown on the counter. To be able to use these frames of film after the counter reaches 1, thus locking the rapid wind lever, press and hold down the film release button; then press the film counter advance in the direction of the arrow as many times as is necessary to bring the diamond-shaped mark on the film counter opposite the notch. The rapid wind lever can then be operated.

**a complete system
of photography with the
RETINA IIIC**

Certain auxiliary equipment has been referred to and described previously in the manual. This equipment and the items that follow are offered to extend the picture-taking scope of your Retina Camera. See your Kodak dealer.

Kodak Retina

filters—filter cases

Filters for both black-and-white and color films are available in screw-in mounts for your camera. The 32mm diam. size fits the standard and $f/5.6$ wide-angle lens; the 60mm diam. size fits the telephoto and $f/4$ wide-angle lens.

For convenient carrying and storage, the Kodak 8-Filter Pocket Case (for 32mm diameter filters), shown below, and the Kodak Retina Filter Compartment Case (for 32mm diameter filters and lens hoods) are available.

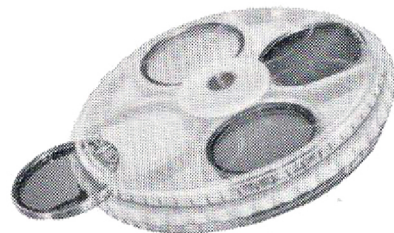

Kodak Retina field case

Model B

Leather with chrome-finished metal reinforcement. Elastic band inside of top is for storing incident light attachment of exposure meter. To remove front of field case, slide attaching button upward.

The Kodak Retina Fitted Case (not illustrated) accepts camera, 2 lens components, and other accessories.



Kodak Retina lens hoods

The Kodak Retina Lens Hood, Bayonet Type (for 50mm lens) is for the standard lens; an extension hood, the Kodak Retina Lens Hood Extension (for 35mm $f/5.6$ lens), slips over the front of the 50mm lens hood. The Kodak Lens Hood (for 80mm lens) and Kodak Lens Hood (for 35mm $f/4$ lens), not illustrated, are slip-on type hoods.

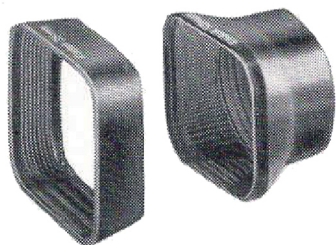

Kodak Retina 50-80 sports finder

This folding, open-frame finder shows the field covered by the 50 and 80mm lenses. Manual parallax adjustment. 80mm finder frames swing in or out of 50mm frame. Chrome finished. Compact. Supplied in leather case attachable to carrying case strap.

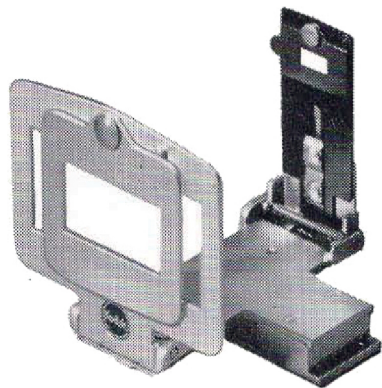

Kodak Retina

close range and viewfinder kit

Model B

This kit is used for optically measuring film-to-subject distances ($38\frac{1}{4}$ to 12 inches), and for determining the precise field covered by the 50mm lens supplemented by the N1, N2, or the combination of the N1 and N2 auxiliary lenses.



Kodak Retina

close-up kit

Model B

This kit measures close distances (11 to 6 inches) and the field sizes mechanically at 4 settings by means of 4 pairs of field guides. For use, the kit requires the Kodak Retina Camera Platform, Model B.

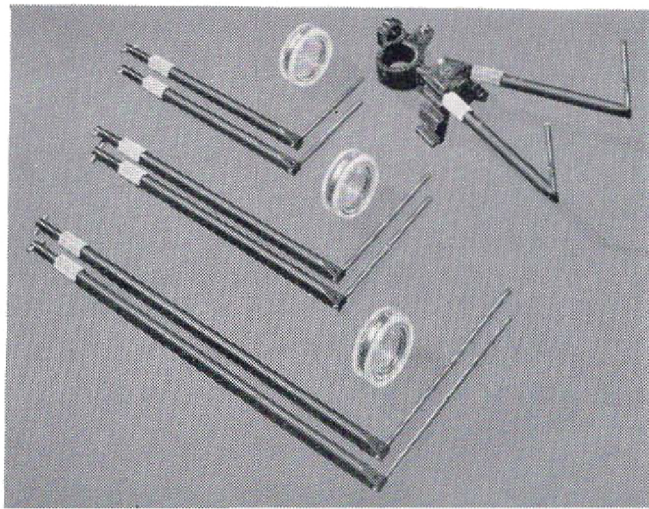

Kodak Retina

camera platform

Model B

This platform fits the bottom of the camera and provides a tripod socket in the center of the camera base. It is required for using certain auxiliary items of equipment.

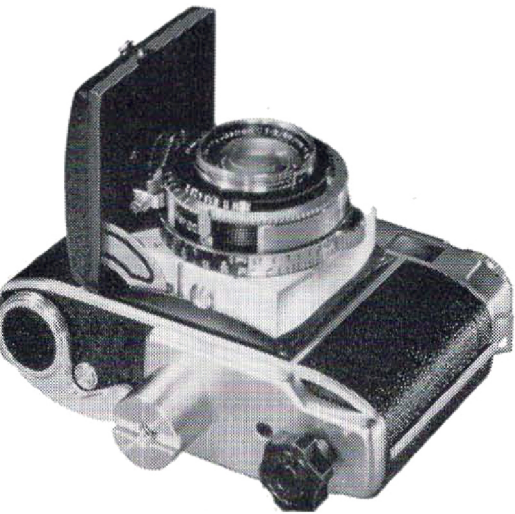

Kodak Retina

microscope adapter kit

Model B

Photomicrographs can be made easily with this outfit. Fits practically all microscopes — eye piece diameter 1 inch. Outfit consists of microscope adapter, clamping ring, and light-value diaphragm locking ring.

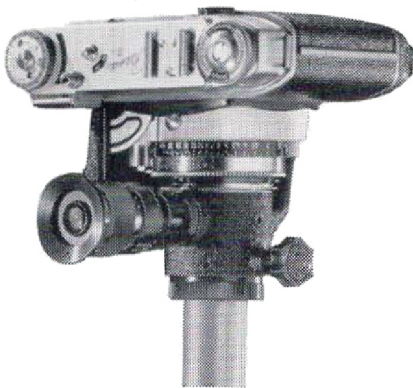

Kodak

table top camera stand

Model B

Consists of the base, 2-section telescoping column, ball-and-socket head, and right angle head. It provides flexible yet rigid support for miniature cameras from a few inches to about a foot above the base. Can be disassembled.

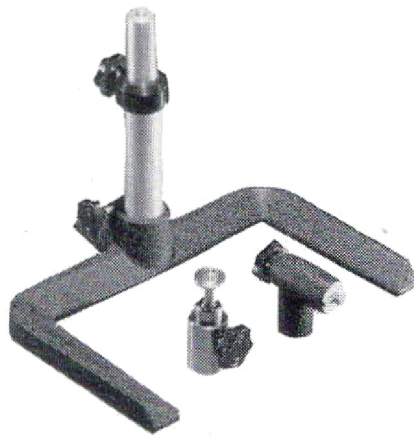

GUARANTEE

Within a year after purchase, any repairs necessary to this Kodak Retina Camera due to a defect in materials or workmanship will be made or, at our option, the camera will be replaced without charge. No other warranty or guarantee, express or implied, shall be applicable to this equipment. Nor are we responsible for loss of film, for other expenses or inconveniences, or for any consequential damages occasioned by the equipment.

In case of unsatisfactory operation, the camera should be sent directly or through a Kodak dealer to Eastman Kodak Company or a repair firm authorized by us to make such repairs. It should be accompanied by a description of the trouble encountered and other available information regarding the camera, including the date and place of purchase.

EASTMAN KODAK COMPANY, Rochester 4, N. Y.

DETAILS

FILM

FILM LOAD—Kodak 135, 20- or 36-exposure magazines

NEGATIVE SIZE—24mm x 36mm

LENS—50mm, *f/2* Retina-Xenon C, coated, 6 elements. Changeable front component held by bayonet-type snap lock; removable to substitute auxiliary lenses

LENS OPENINGS—*f/2*, *f/2.8*, *f/4*, *f/5.6*, *f/8*, *f/11*, *f/16*, *f/22*

SHUTTER

SYNCHRO - COMPUR — Automatically cocked when film is advanced

SPEEDS—1, 1/2, 1/4, 1/8, 1/15, 1/30, 1/60, 1/125, 1/250, 1/500 and "B"

RELEASE—plunger type on top of camera, or Kodak Metal Cable Release No. 5

SELF-TIMER—Built-in, selector at "V," about 10 seconds delay

FLASH—Built-in synchronization for class F, M, and electronic flash

EXPOSURE METER—Integral part of camera. Element is moisture sealed. Reads reflected and incident light (with mask)

FOCUSING AND VIEWING

COUPLED RANGE FINDER — Superimposed-image type combined with viewfinder

VIEWFINDER — Optical, projected view-frame type showing fields covered by 35, 50, and 80mm lenses

FOCUSING RANGE—2½ feet to infinity

DOUBLE EXPOSURE PREVENTION—Automatic; multiple exposures possible

RAPID WIND LEVER—Advances film and sets shutter with one stroke

CONSTRUCTION

BODY—Die-cast aluminum alloy, black leather covered

TRIPOD SOCKET—In camera base

FILTERS AND LENS HOODS—Kodak Filters (Screw-in type, 32mm diameter) for 50mm *f/2* and 35mm *f/5.6* lenses.

Kodak Filters (Screw-in type, 60mm diameter) for 80mm and 35mm *f/4* lenses. Kodak Retina Lens Hood, Bayonet Type, for the 50mm *f/2* lens; and with the Kodak Retina Lens Hood Extension for 35mm, *f/5.6* lens.

Kodak Retina Lens Hoods (Slip-on type) for 80mm, *f/4* lens and 35mm *f/4* lens.

EASTMAN KODAK COMPANY • ROCHESTER 4, NEW YORK