

Kodak
Made in Germany

INSTAMATIC
REFLEX CAMERA



KODAK INSTAMATIC® REFLEX CAMERA

Kodak Instamatic reflex camera

This continental member of the KODAK INSTAMATIC family is designed with true precision craftsmanship. It combines operating simplicity with a high level of capability. Features of this versatile camera include:

- **Instant Loading and Unloading**—Merely drop in or remove a 126 film cartridge.
- **Single Lens Reflex Viewfinding**—Provides direct parallax-free viewing through the same lens that takes the picture. Previews depth-of-field through the ground-glass screen.
- **Compur Electronic Shutter**—Simply select the lens opening—even in-between openings can be set. A viewfinder scale indicates the shutter speed at which the correct exposure will be made automatically. Automatically-timed shutter speeds range from 1/500 second to as long as 20 seconds.
- **Interchangeable Lenses**—A complete family of wide-angle, normal, and telephoto lenses, plus other aids for special applications, is available.
- **Automatic Features**—Automatic daylight exposure control with manual aperture control, automatic flash exposure control (45mm, $f/2.8$ lens), flash exposure indication ($f/1.9$ lens), and automatic flashcube rotation are built in.

Picture-Taking can be easy as ABC

After inserting the batteries and film cartridge, simply do this . . .

OUTDOORS

A—Set the bright-sun symbol (☀) or cloudy symbol (☁), whichever represents the light condition, opposite the index mark. (Details page 11)

B—Look through the viewfinder and rotate the front, knurled lens mount until the subject appears sharp. (Details page 9)

C—Press the shutter release to take the picture. (Details page 8)

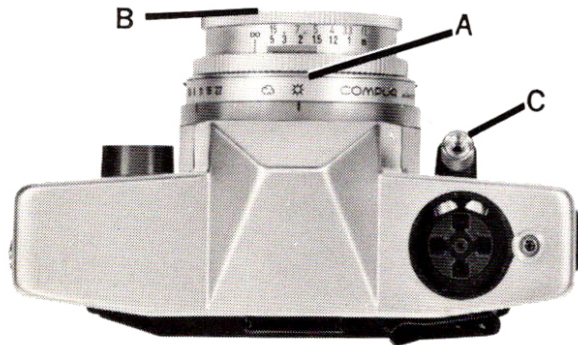

INDOORS (with 45mm, f/2.8 lens)*

A—Set the camera for automatic flash control (couple distance and lens opening scale); insert a flashcube. (Details page 16)

B—With the subject 5 to 23 feet from the camera, look through the viewfinder and rotate the front, knurled lens mount until the subject appears at its sharpest.

C—Press the shutter release to flash the bulb and take the picture.



. . . for the important details of camera operation, carefully read the instructions which follow.

*For f/1.9 lens, see page 18.

Install Batteries

Install batteries before taking any pictures. Use two fresh PX825-size batteries to power the daylight exposure control and to fire flashbulbs.

Before installing batteries, clean battery contact surfaces with a rough cloth. Then, press the thumbnail LATCH of the battery clip (on bottom of camera) toward the front of the camera; the BATTERY CLIP will spring out so it can be withdrawn for loading. As shown in the illustration, slide

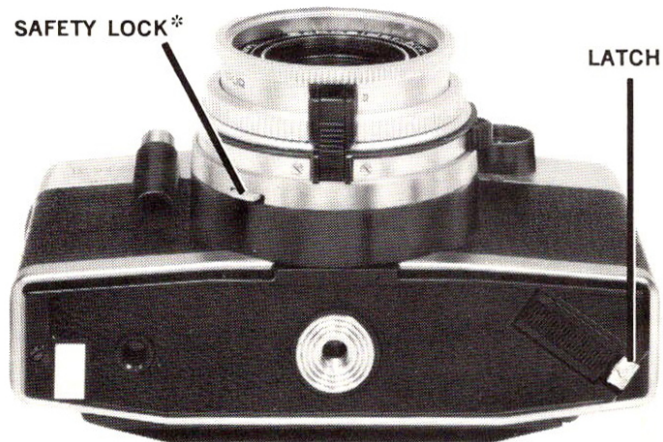

*For interchanging lenses. See pages 20 and 21.

one battery, positive (+) side **up**, into the open end of the clip; press the other battery, positive (+) side **down**, into the remaining circular recess in the clip—**press down firmly to seat**. (For handy reference in positioning batteries, minus and plus cut-outs appear in the contacts of the clip.) Replace the clip in its camera recess with the clip LATCH toward the back corner of the camera, as shown. **Make sure the clip is all the way in.**

NOTE: To insure most dependable service, clean battery contact surfaces periodically with a rough cloth. For maximum protection of camera contacts, batteries may be removed if camera is stored.

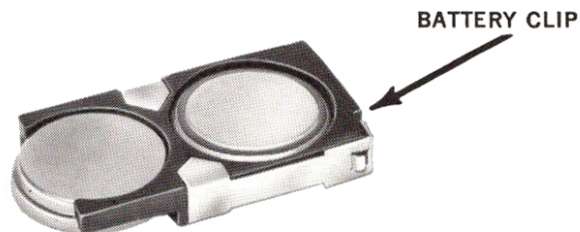

Battery Testing

A built-in battery tester permits you to easily check the present condition of your batteries. Merely look through the viewfinder eyepiece and slide the TEST BUTTON on the side of the camera all the way down; if the needle in the viewfinder drops into the corner notch at the bottom of the shutter speed scale, the batteries are satisfactory. If not, clean battery contact surfaces with a rough cloth; then, re-install, re-check, and, if necessary, replace batteries.

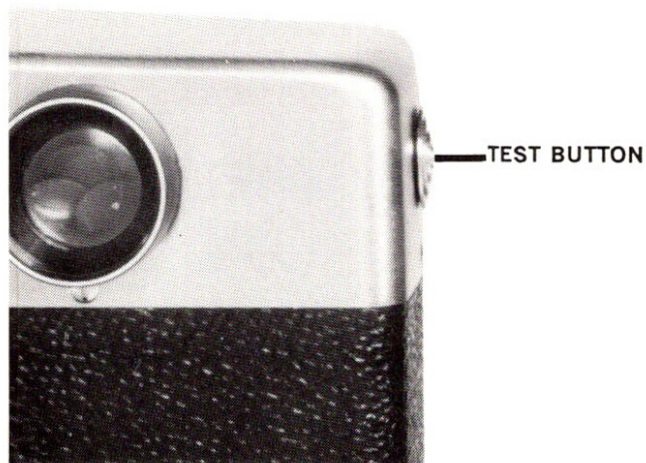

Film

Your camera accepts KODAK Film in the 126 film cartridge for instant loading and unloading. Choose, from the table below, the film that produces the type of pictures you want.

Type of Picture	KODAK Film	No. of Exposures	Produces (order from dealer or purchase Pre-paid Processing Mailer)
Black-and-White Prints	VERICHROME Pan	12	3½ x 3½-inch black-and-white prints or enlargements.
	TRI-X§	12	
Color Prints	KODACOLOR-X	12 or 20	3½ x 3½-inch color prints or enlargements.*
Color Slides	KODACHROME-X	20	Color slides, mounted in 2 x 2-inch cardboard mounts for projection or viewing.†
	EKTACHROME-X	20	
	High Speed EKTACHROME§	20	

*Color slides are also available from your KODACOLOR-X negatives.

†Duplicate slides or enlarged color prints can be made from your original slides.

§Extremely fast film. Ideal for daylight pictures of dimly lighted subjects.

Loading

1. Open the back of the camera by pressing in the **LOCK** button on the bottom of the camera to pop open the hinged cover; then swing out the cover, as far as it will go.
2. Place a film cartridge in the camera, as illustrated, with the larger cylindrical end down and toward the lock button.
3. Close the back of the camera by pressing the back against the body until it locks.

The film name and number of exposures per cartridge appear in the **WINDOW** on the back of the camera. The camera is now automatically set for the proper film speed.

4. Swing out the **FILM ADVANCE** lever as far as it will go toward the right, and allow it to return; repeat until the lever locks (about 7 full strokes). The appearance of a series of arrows in the center of the win-

1

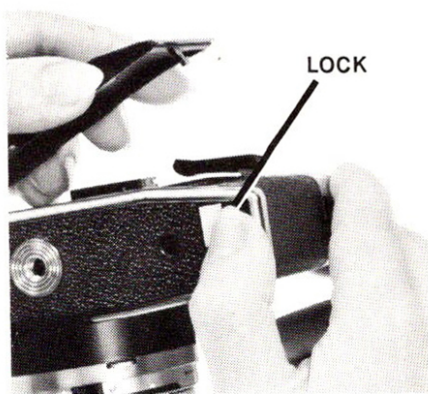

2

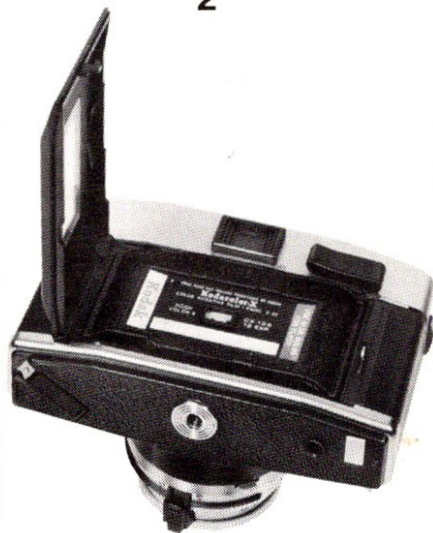

3

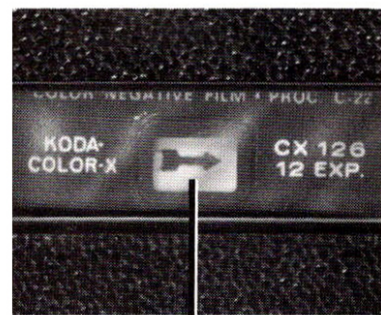

WINDOW

Unloading

dow indicates that the film is advancing toward the first exposure. After each picture, smoothly operate the film advance lever one full stroke to advance the film.

The number that appears in the center of the window on the back of the camera (shown below, right) serves as your exposure COUNTER. The same number may appear in duplicate.

4

FILM
ADVANCE
LEVER



COUNTER

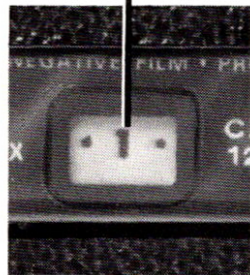

1. After the last picture, operate the film advance lever until it locks, before you open the back of the camera. The appearance of an "X" in the center of the window indicates that the film has been exposed, but that the backing paper has not been fully wound into the take-up chamber. Do not remove the cartridge from the camera until all the yellow paper, with the "Xs," has been moved past the window; otherwise the last exposures may be "light-fogged."

2. Press in the lock button; open the back.

3. Remove the cartridge by turning the camera over to allow the cartridge to fall into your hand. Close the back of the camera. **Do not open the cartridge** (except in darkroom, for home processing) or your pictures will be ruined.

NOTE: Removing and replacing a partially-exposed cartridge, even under darkroom conditions, may result in loss of at least one exposure.

Film Advance and Shutter Release

Always swing out the **FILM ADVANCE LEVER** to the limit of its travel; then let it return to its original position. This advances film for the next exposure, sets the shutter, provides a large lens opening for viewing and focusing, and fully powers the shutter speed pointer.

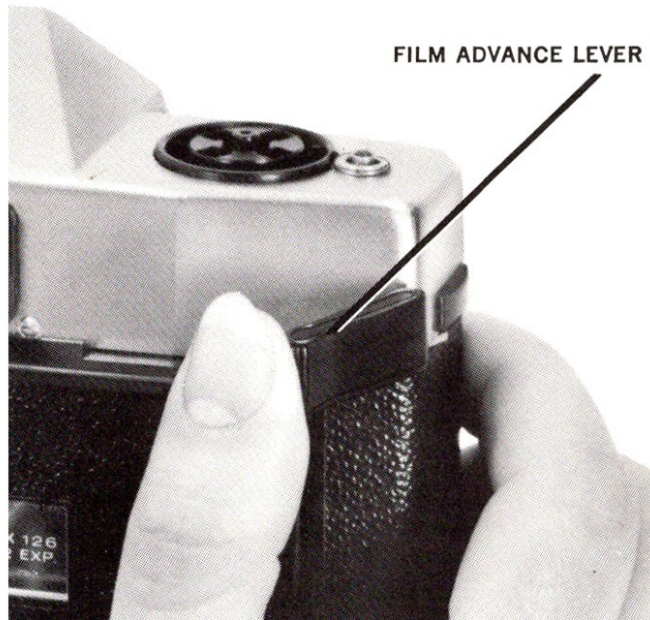

Because of the double-exposure prevention feature of your camera, the **SHUTTER RELEASE** can be depressed only after the film advance lever has been operated. For picture-taking, press down the shutter release as far as it will go with a **slow squeezing action**.



Viewing and Focusing

Swing out the film advance lever fully; then let it return. Grip the camera with both hands and look through the eyepiece. Hold the camera at that distance from the eye which allows you to see all of the ground glass. In the center of the ground glass screen, you will see a circle divided by a diagonal line; this is the split-image rangefinder.

There are three methods of focusing the camera correctly—by means of the ground glass, with the aid of the rangefinder, or by the distance scale. The nature of the subject indicates largely which method is more suitable.

Subjects without prominent horizontal or vertical lines are more easily focused on the ground glass screen. But if the subject has such lines, the rangefinder is probably more suitable for focusing.

Using Ground Glass Screen—Turn the knurled distance-scale ring, at the front of the lens mount until the subject you are picturing appears at its sharpest on the ground glass.



Using Rangefinder—Aim the camera so that the circular area in the center of the screen covers a vertical or horizontal line of the subject. Turn the distance-scale ring—the image in the upper half of the circle will move relative to that in the lower half. When the two halves line up exactly, the camera is correctly focused.

Using Distance Scale—Rotate the distance-scale ring on the front of the lens until the film-to-subject distance*, in feet (red figures), is opposite the triangular, black FOCUS INDEX (shown opposite). The black figures are film-to-subject distances in meters.

*The film plane coincides with the back of the camera at the eyepiece.

Shutter Speed Scale—Also visible at the right side of the viewfinder, is the shutter speed scale. Use of this scale is described on page 13.

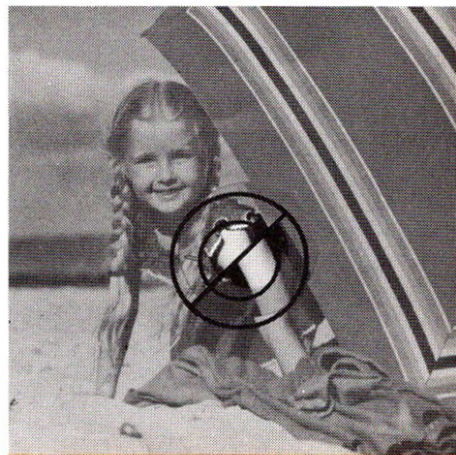

OUT
OF
FOCUS

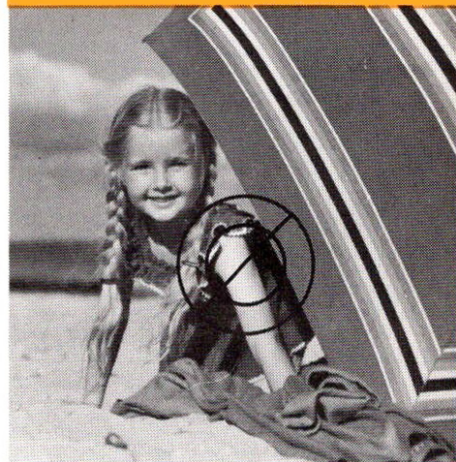

IN
FOCUS

Depth of Field

When the lens is properly focused (set for the film-to-subject distance) the subject will be optically sharp in the picture. However, other objects, both in front of and behind the subject will also appear sharp in the picture. This range of sharpness is known as “depth of field.” For any one distance setting, the larger the f -number (the smaller the lens opening) the greater will be the depth of field. Depth of field is visible on the ground glass **before film is advanced.**

To provide numerical indication of the depth of field, a depth scale, composed of numbers corresponding to lens openings is arranged on both sides of the triangular black index. The dots between 4 and 8 indicate the depth at $f/5.6$. The method of determining depth of field by the scale is illustrated and described opposite.

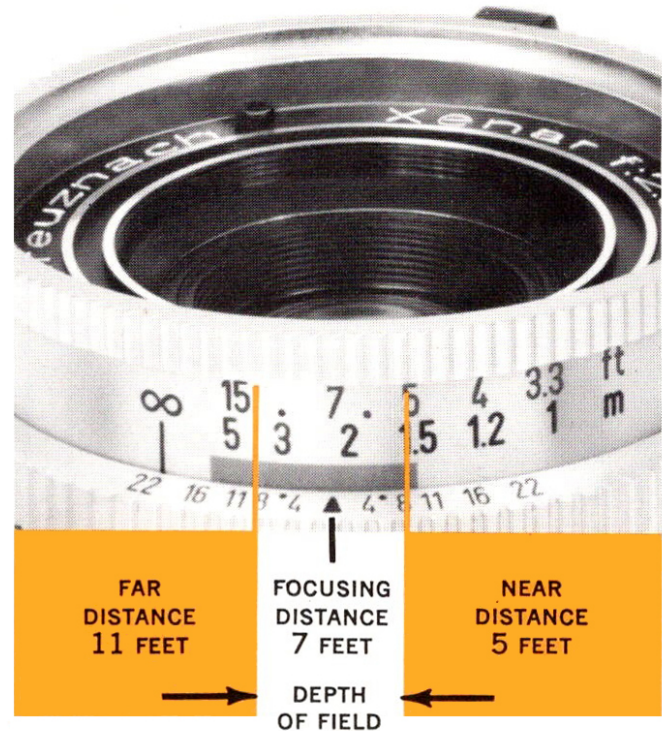

For Example—The illustration shows the focus set for 7 feet. If the lens opening (f -number) is set at $f/8$, then the depth of field is from about 5 feet to about 11 feet, shown by the distance figures (on the lens mount) opposite the figure 8, one on each side of the focusing mark. At the $f/16$ setting, the depth of field would extend from about 4 to 25 feet. The depth of field for other lens openings is read in the same manner.

Exposure Control

The shutter speeds of your camera range from 1/500 second to as long as 20 seconds. They are automatically controlled (by the amount of light reflected to the electric eye by the subject) to provide suitable exposure with the light-condition symbol or lens opening that is set.

Automatically-Timed Exposures (1/500 to 1/30 second): The SHUTTER SPEED SCALE is visible at the right side of the viewfinder as you look through the eyepiece. The numbers on the scale represent fractions of a second; that is, 30 = 1/30 sec., 60 = 1/60 sec., etc. The fastest shutter speed is 1/500 sec.

To obtain a faster shutter speed (for perhaps an action shot) or a slower shutter speed than that pointed out by the NEEDLE, rotate the lens-opening scale; this automatically provides the desired shutter speed without changing the exposure. If the needle enters the BRACKET at the top of the scale, this indicates that a shutter speed slower than 1/30 second is required—either an **automatically-timed exposure**

Caution: Make sure that the ELECTRIC EYE is not obstructed during picture-taking by the fingers or any other object and that the camera is not pointed toward the sun or other bright light-source.

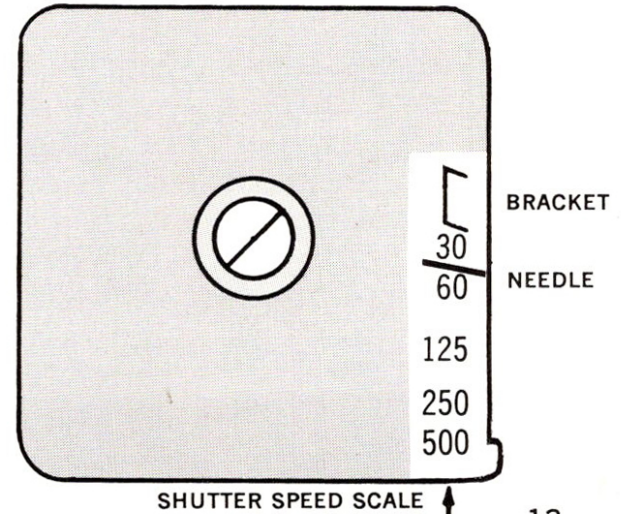

to as long as 20 seconds (as below), or an extended time exposure, as described opposite. To get sharp pictures at these slow shutter speeds, the camera must be held rock steady; therefore, if possible, set a larger lens opening to provide a shutter speed of 1/30 second or faster. If a larger lens opening cannot be set (or is not desirable because of depth-of-field consideration), place the camera on a tripod* for an automatically-timed exposure of up to 20 seconds as described below.

Automatically-Timed Exposures (Just-slower-than 1/30 sec. to as long as 20 sec.): When the pointer is within the bracket, this indicates longer exposures. The camera must be held extra steady during exposure, to avoid camera movement which causes blurred pictures. Therefore, place the camera on a tripod or some other solid support. Also avoid subject movement for sharp pictures at these slow shutter speeds. To take the picture, press

*With some tripods (other than those with adjustable attaching screw) the length of the screw exceeds established standards. With these tripods, seat the camera firmly, by using a washer or shortening the screw.

down but do not hold the shutter release. The shutter closes automatically for exposures of up to 20 seconds; if it remains open, proceed as described below.

Extended Time Exposures (Longer than 20 seconds): These exposures are **not** automatically timed by the exposure control of the camera. To get sharp pictures, avoid movement of the camera and the subject.

To make the exposure, cover the **ELECTRIC EYE** so that it is lighttight (with opaque tape, for example), select the lens opening desired, focus the camera for the subject distance, and press down, but do not hold, the **SHUTTER RELEASE** to open the shutter; at the end of the exposure time, close the shutter by depressing the **POST** in the center of the flashcube socket.

This post can also be depressed to close the shutter at any time that the light-level is so low that the exposure control does not close the shutter automatically in up to 20 seconds.

NOTE: To further minimize the risk of camera movement during exposures longer than 1/30 second, use of a cable release is suggested. Screw the release into the threaded socket on top of the shutter release.



Outdoor Picture-Taking Summary

1. Swing out the film advance lever all the way to set the shutter and advance film.
2. Set the lens opening by rotating the lens opening scale until the proper light-condition symbol is opposite the symbol pointer, or the desired lens opening value ($f/1.9$ or $f/2.8$ to $f/22$) is opposite the lens opening index.

3. Look through the viewfinder eyepiece and . . .

- note the shutter speed selected automatically by the electric eye. If the needle indicates a shutter speed slower than $1/30$ (in bracket at top of scale), either place the camera on a solid support or change the lens opening to automatically give a more useful shutter speed. If the needle goes beyond 500, adjust the lens opening until the needle is within the scale.

- Focus the camera by using the range-finder, ground glass or distance scale.

- Compose the picture, hold the camera steady, and press the shutter release **all the way down to take the picture.**

Indoor Pictures with Flash

Your camera features easy, rapid flash picture-taking in the 5- to 23-foot range, with the rotating flashcube.* The electric eye does not control flash exposures; therefore disregard the position of the needle in the viewfinder.

1. Insert Flashcube

Insert a FLASHCUBE in the flash socket on the top of the camera; then press down the cube until it snap locks in place with

*For flash distances other than 5 to 23 ft. and for high-speed films, such as KODAK High Speed EKTACHROME or TRI-X Film, see the instructions with the flashcubes or film cartridge.

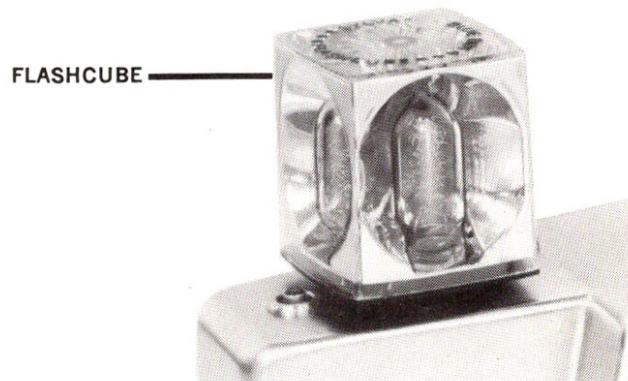

one of its four bulbs facing forward in its detent (click-stop) position. The shutter speed is now automatically set for 1/30 second. The cube revolves $\frac{1}{4}$ -turn clockwise each time the film is advanced for the next exposure, thus providing flash for four exposures if a fresh cube is in place. To remove a used or partially-used cube from the camera, lift it out of the socket. When placing a used cube on the camera, make sure that a **fresh bulb is facing forward** before the exposure is made.

IMPORTANT: Turn the flashcube in a **clockwise** direction, only.

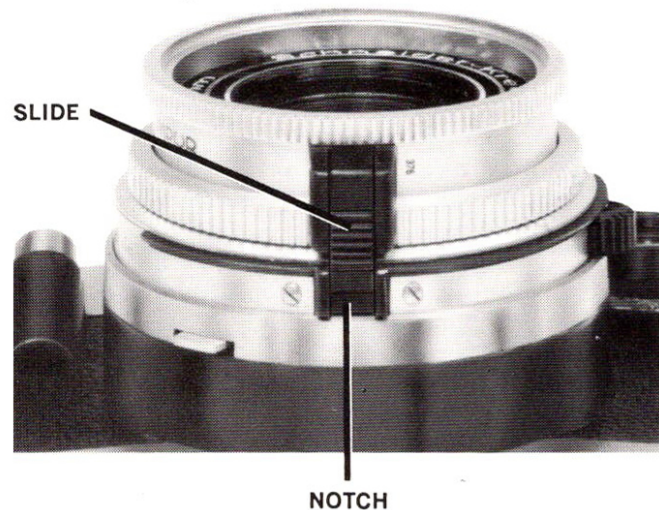

2. Set the Exposure (Distance and Lens Opening)

With the f/2.8, 45mm Lens: Coupling the lens opening scale with the focus (distance) scale, provides **automatic exposure control**—the correct lens opening is automatically set as you focus the camera for subject distances from 5 feet to 23 feet (indicated by the blue band on the distance scale). To couple the scales, rotate the lens mount until the black ribbed SLIDE is opposite the black plastic NOTCH on the bottom of the mount. Insert the slide in the notch.

- Set the distance (focus) by rotating the distance scale (now coupled with lens opening scale) until the subject is in focus. Subjects must be in the 5- to 23-foot range.

NOTE: For operations other than flash-exposure control purposes, **make sure that the slide is withdrawn from the notch.**

With the $f/1.9$, 50mm Lens: Lens opening settings are not coupled with distance settings for automatic flash exposure control with this lens. They must be set independently.

- Focus the camera for the correct camera-to-subject distances in the 5- to 23-foot range by means of the rangefinder, ground glass, or distance scale. The illustration shows a distance setting of 6 feet.

- A reference scale on the underside of the lens mount **points out** the correct lens opening to use with the distance now set. Note this lens opening number opposite the FLASH SYMBOL. The illustration shows a lens opening of $f/11$ opposite the symbol.

- Set the lens opening by rotating the lens opening scale until the lens opening number noted (in previous step) is opposite the LENS OPENING INDEX.

With Interchangeable Lenses without Flash Coupling or Reference Scale: After focusing the camera for the correct subject dis-



tance, set the lens opening scale according to the instructions supplied with the flashcubes or the film cartridge.

3. Take the Picture

Compose the picture in the viewfinder and press the shutter release all the way down (with a slow, squeezing action) to flash the lamp and take the picture.

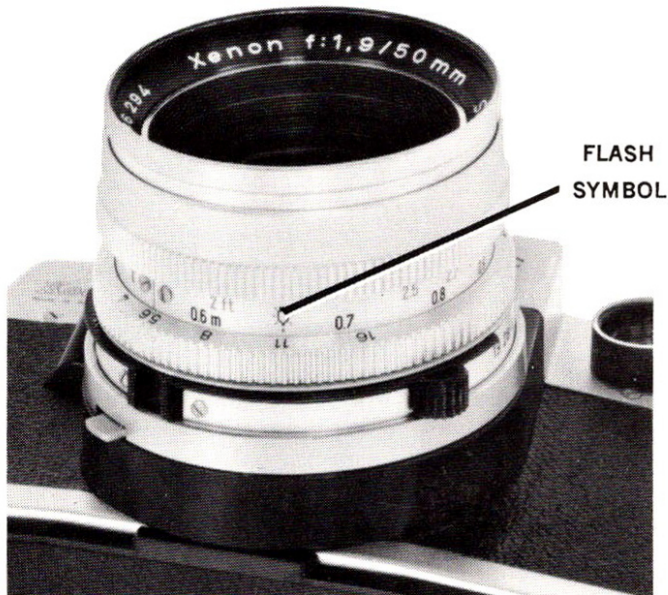

Electronic Flash

Your INSTAMATIC Reflex Camera also accepts electronic flash with a standard connecting cable. Plug the cable into the AUXILIARY SOCKET on the top of the camera; this automatically sets the shutter for 1/300 second. See the instructions packaged with your flash unit. Flashcube and electronic flash cannot be used simultaneously.

Photo Aids

The following specially designed photo aids offer convenience and extend the picture-taking range of your KODAK INSTAMATIC Reflex Camera. See your Kodak dealer for these and additional photo aids.

Interchangeable Lenses

These superb telephoto and wide-angle lenses extend the picture-taking scope of your INSTAMATIC Reflex Camera. In addition to the choice of two

standard lenses—the Xenar Lens, 45mm $f/2.8^*$, or the “faster” Xenon Lens, 50mm $f/1.9^*$, there is also a choice of three telephoto and two wide-angle lenses. See comparison pictures below.

*To view at maximum aperture, set the lens at maximum aperture.

Telephoto Lenses†

The Tele-Arton Lens, 85mm $f/4$, gives almost twice the image size, the Tele-Xenar Lens, 135mm $f/4$, gives almost three times the image size, and the Tele-Xenar Lens, 200mm $f/4.8$, gives four times the image size of the standard lens at the same distance. These long-focus

†Same as supplied under KODAK RETINA label.

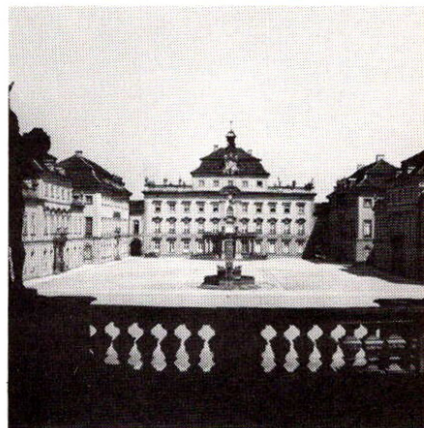

Wide-Angle (28mm)



Standard (50mm)



Telephoto (135mm)

lenses are important for bringing action closer in shooting sports events, for photographing distant scenery, and for taking "close-ups" from a distance.

Wide-Angle Lenses†

The Curtagon Lens, 35mm $f/2.8$, and the Curtagon Lens, 28mm $f/4$, are available for covering a wider area than the standard lens. These short-focus lenses allow you to get the subject into the picture when there is little room to move back.

Note: The interchangeable lenses described above are complete units and are easily interchanged. To remove a lens, just hold down the

†Same as supplied under KODAK RETINA label.

SAFETY LOCK on the underside of the lens mount; then turn the lens counterclockwise and lift it off. To attach a lens, first set the lens opening between $f/5.6$ and $f/22$. Then line up the red dot on the inside shoulder of the lens mount, with the red dot on the rim of the shutter; then insert the lens and turn it clockwise until the safety lock engages.

KODAK INSTAMATIC Reflex Field Case—Attractively styled in black with chrome-finish trim. To remove the front of the case, slide the open front and attaching buttons to the left.

KODAK INSTAMATIC Reflex Fitted Case†—Stores several lenses plus photo aids, such as lens hood, filter, and close-up lenses.



KODAK INSTAMATIC Reflex Right-Angle Finder*—Makes copying, low-angle views, and similar phases of photography easier. Fits, with adapter, over finder eyepiece of camera. Supplied in leather case.

KODAK INSTAMATIC Reflex Close-Up Lens Set, Type N/29.5mm*—For direct use with the 45mm *f*/2.8 lens; and with the 50mm *f*/1.9 lens (with the KODAK INSTAMATIC Reflex Step-Down Ring as described below). This lens set consists of an N1 lens and an N2 lens. These lenses can be used either singly or in combination to extend the focusing range of the camera down to about 12 inches, film-to-subject distance.

KODAK INSTAMATIC Reflex Close-Up Lens Set, Type R/29.5mm*—For use with the 45mm *f*/2.8 lens directly, and with the 50mm *f*/1.9 lens used together with the INSTAMATIC Reflex Step-Down Ring. This set of three lenses is useful for taking extreme close-ups of small objects and for copying. These lenses allow focusing from about 11 inches to 7 inches.

KODAK INSTAMATIC Reflex Step-Down Ring, 52/29.5—For using single Type N or Type R/32 close-up lenses, with Xenon Lens, 50mm *f*/1.9.

KODAK INSTAMATIC Reflex Microscope Adapter—Photomicrographs can be made easily with this outfit because the electric eye provides correct exposures up to an exposure time of 20 seconds. Fits practically all microscopes with ocular diameter of 25mm.

KODAK Flashcube Extender—Increases the distance between the lens and the flashcube to produce more pleasing modeling and shadow effects in close-ups.

KODAK INSTAMATIC Reflex Lens Spacer—Fits between the camera body and the lens to permit picture-taking at closer than the minimum focusing distances. Can be used with all lenses.

KODAK INSTAMATIC Reflex Camera Stand Kit—Provides a flexible yet rigid support for the camera from a few inches to about a foot above the base. It is especially useful for copying and in tabletop photography. Can be disassembled for storage or carrying.

KODAK INSTAMATIC Reflex Lens Hood 29.5mm*—Fits the 45mm *f*/2.8, the 35mm *f*/2.8, and the 85mm *f*/4 lenses. When not in use, this flexible hood can be rolled back while on the lens. It can be rolled forward when needed to protect the lens from extraneous light.

KODAK Projectors—A KODAK Projector will show your slides big, bright, and sharp on the screen. Ask your dealer to show you one of the revolutionary KODAK CAROUSEL Projectors. Features round, 80-slide trays which can be changed easily and quickly. Other features include remote controls, instant editing, and high-watt power. Choice of models.

*Same as supplied under KODAK RETINA label.

Details

Film

Film Size—Kodak film in 126 cartridge; 12- or 20-exposures.

Film Format—28 x 28mm.

Lens

Xenon Lens, 50mm, $f/1.9$, or Xenar Lens, 45mm, $f/2.8$. Removable to attach wide-angle or telephoto lenses.

Lens Openings—($f/1.9$), $f/2.8$, $f/4$, $f/5.6$, $f/8$, $f/11$, $f/16$, and $f/22$; with $\frac{1}{3}$ -stop intermediate settings.

Lens Mount—Screw-in type. Thread diameter: $f/2.8$ —29.5mm; $f/1.9$ —52mm.

Shutter

Compur Electronic—Automatically cocked when film is advanced.

Speeds—From $1/500$ second to as long as 20 seconds, automatically controlled by CdS cell; indicated in viewfinder; also time exposures.

Release—On front of camera, or by cable release.

Exposure Controls

Daylight: Film Speed set automatically by film cartridge (ASA 64/80/125 or 160).

- Shutter speed electrically determined by CdS electric eye.

Flash: Built-in socket for 4-bulb flashcube.

- Flash shutter speed of $1/30$ second automatically set by inserting flashcube.
- With 45mm $f/2.8$ lens—correct lens opening is automatically set by focusing.

- With 50mm $f/1.9$ lens—correct lens opening is indicated by flash symbol.
- Outlet for electronic flash—shutter speed is automatically set at $1/300$ second.

Viewing and Focusing

Viewfinder—Pentaprism-type, parallax-free with all lenses. Instant mirror return.

Focusing Range—2 feet to infinity with $f/1.9$ lens; 3.3 feet to infinity with $f/2.8$ lens.

Coupled Rangefinder—Split-image type, combined with viewfinder—all lenses.

Ground-Glass Focusing—With extra-fine ground glass—all lenses.

Film Advance

Lever advances film, sets shutter and fully powers the shutter speed pointer with one stroke. Double exposure prevention.

Other Features

- Instant loading
- Battery tester
- Uses two PX825 batteries to power electronic shutter, CdS exposure control, and flash.

Construction

Body—Die-cast aluminum alloy, black covering.

Tripod Socket—In camera base.

Photo Aids

A complete line of specialized photo aids extends the picture-taking scope of your camera. See listing on pages 20 to 22.

Service Facilities

If this camera should require attention, complete service facilities are provided at Rochester, New York, and Kodak's Regional Marketing and Distribution Centers from coast to coast at the addresses shown at right. Also, service covered under the warranty is available through independent service shops in many cities. For such local, warranty-covered service, please see your Kodak dealer or refer to the yellow pages of your telephone directory under "Photographic Equipment and Supplies—Factory Approved Warranty Service."

Eastman Kodak Company, Central Equipment Services Center
800 Lee Road, Rochester, New York 14650

Eastman Kodak Company, Regional Equipment Services Center
1901 West 22nd Street, Oak Brook, Illinois 60523

Eastman Kodak Company, Regional Equipment Services Center
1400 Hi Line Drive, Dallas, Texas 75207

Eastman Kodak Company, Regional Equipment Services Center
5315 Peachtree, Industrial Blvd., Chamblee, Georgia 30005

Eastman Kodak Company, Regional Equipment Services Center
3250 Van Ness Avenue, San Francisco, California 94119

Eastman Kodak Company, Regional Equipment Services Center
1334 York Avenue, New York, New York 10021

Eastman Kodak Company, Regional Equipment Services Center
12100 Rivera Road, Whittier, California 90606

Eastman Kodak Company, Regional Equipment Services Center
1065 Kapiolani Blvd., Honolulu, Hawaii 96807

Warranty

Within a year after purchase, any repairs necessary to this KODAK INSTAMATIC Reflex Camera—bearing a serial number with "EK" prefix—due to a defect in materials or workmanship will be made or, at our option, the camera will be replaced without charge. No other warranty, express or implied, shall be applicable to this equipment. Nor are we responsible for loss of film, for other expenses or inconveniences, or for any consequential damages occasioned by the equipment.

In case of unsatisfactory operation, the camera should be sent directly or through a Kodak dealer to Eastman Kodak Company or a repair firm authorized by us to make such repairs. It should be accompanied by a description of the trouble encountered and other available information regarding the camera, including the date and place of purchase.

EASTMAN KODAK COMPANY • Rochester, New York 14650