

Kodak

EKTACHROME

film

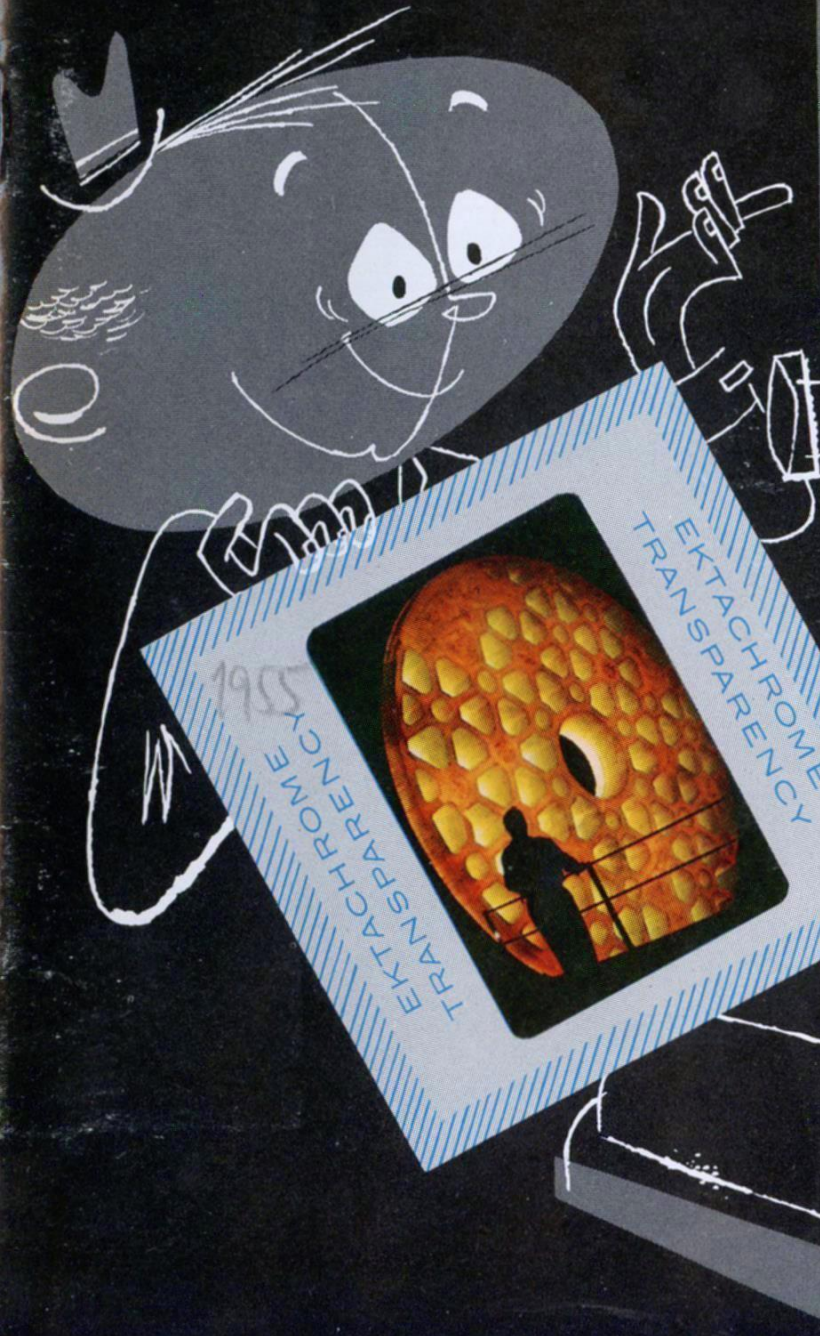

A
Kodak
Publication



IN

S LEAGUE,

every miss is an out!

Picture taking, in fact, is really a lot more like fishing than baseball. When there's a fine snapshot situation, you either seize it or you don't, and one that gets away is usually gone for good.

There's hardly a more futile combination of words in the language than, "Wouldn't that have made a terrific picture." Only by keeping your camera pretty constantly at hand can you detour around them.

But your camera's eye is a blind one. Only color film can help it capture an instant of time and give that instant a crowning glow of reality.

Your Ektachrome Pocket Exposure Guide is at the back of the book

Ektachrome Film does this superlatively well. It's a well-balanced, all-round film that will give you soft colors where you want them and should be soft and sparkling colors where you expect some sparkle. With Ektachrome, you'll snap more kinds of color pictures than ever before. If you wish, process the film yourself; if you don't, your Kodak dealer will be glad to make the arrangements for you.

First. Then, load up.

Remember, make sure you keep your camera with you. It's not a camera that doesn't count at all.

contents

Introducing Ektachrome	2
Words To Work With	4
Trying Out A New Film	6
Under The Sun	7
Snapshots Without Sunlight	10

Processing Equipment	27
Mixology	29
Step By Step	30
Signposts For Slide Shows	32
Loose Ends	33
Processing Primer	16
Lighting	18
Aperture	22
Shutter Speed	25
Pre-Processing Primer	26



Picture taking, in fact, is really a lot more like baseball. When there's a fine snapshot scene, you either seize it or you don't, and one that usually goes for good.

There's hardly a more futile combination of the language than, "Wouldn't that have made a picture." Only by keeping your camera perpetually at hand can you detour around them.

But your camera's eye is a blind one. Only you can help it capture an instant of time and stand a crowning glow of reality.

Your Ektachrome Pocket Exposure Guide is at the back of the book

THIS LEAGUE, *a near miss is an out!*

Kodak Ektachrome Film does this superlatively well. It is a fine all-round film that will give you soft colors where they should be soft and sparkling colors where you would expect some sparkle. With Ektachrome, you'll be able to snap more kinds of color pictures than ever before and, if you wish, process the film yourself; if you don't wish, your Kodak dealer will be glad to make the arrangements.

So, read first. Then, load up.

And then, make sure you keep your camera with you. Near misses don't count at all.

contents

Introducing Ektachrome	10
Words To Work With	11
Trying Out A New Film	12
Under The Sun	13
Snapshots Without Sunlight	14

Filterings	16	Processing Equipment	27
Flash!	18	Mixology	29
Flash Hits The Ceiling	22	Step By Step	30
Handling A Flood	25	Signposts For Slide Shows	32
Pre-Processing Primer	26	Loose Ends	33

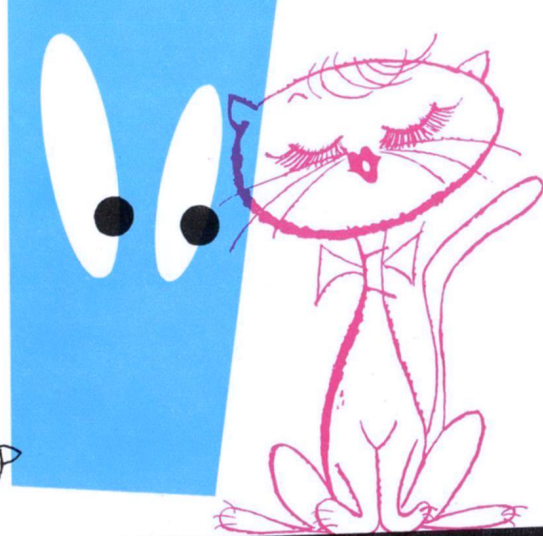
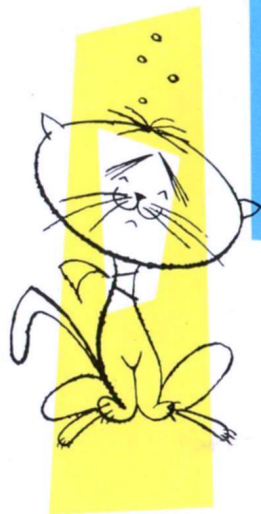

INTRODUCING EKTACHROME

While all little girls may be made of sugar and spice, the ingredients aren't always equally distributed. Some of them generally turn out to be a good bit sugarier or spicier than others. Color films, too, though they bear certain apparent resemblances to one another, measure up quite differently in some characteristics as basic to them as seasoning is to girls. So, taking yardstick in hand, let's explore a few of Ektachrome's dimensions.

Film Speed is to snap shooting what horsepower is to driving. It's a measure, expressed in terms of an exposure index, of how little light a film needs to make a good picture. High speed puts extra muscles on your camera, lets you jack-rabbit away into snapshots with great depth of sharp focus, fast action-stopping shutter times, or pictures made under weak natural light. While you'll seldom need all the speed a fast film can deliver, it's comfortable to know you have this extra photographic power on demand.

Ektachrome is definitely in the Indianapolis Speedway class among color films. Its exposure index for Daylight Type is a zippy 32; its basic exposure for bright sunlight, 1/50 second at *f*/11.

Sharpness, assuming you've focused accurately and held the camera steady, is as much a characteristic of a film as your ten tiny fingers and ten tiny toes are a characteristic of you. A well honed straight razor will look as if it had been molded of oleomargarine if photographed on a film incapable of producing a sharp image. Ingredients of sharpness are resolution (distinctness of the various picture elements), graininess (how apparent the picture-forming dye particles are), and contrast.

Ektachrome pictures will still look crisp and well defined when either projected on home screens or enlarged many times in photographic color printing or photo-mechanical reproduction. Sharpness is extremely good.

Processing of color films depends upon chemical substances called "couplers." A coupler, by itself, can't provide color any more than a cat, by itself, can start a cat fight. Couplers need something to couple to. This something is a substance in the film developer which, when combined with one kind of coupler, makes a yellow dye; with another, light blue-green dye; and with a third, magenta dye. In various combinations, these three dyes can form an infinite variety of colors and shades.

Ektachrome film has its couplers as standard equipment, built right in at the Kodak factory. Only one color developer is needed to get all three couplers bursting into bloom. This makes it easy for either color photofinishers or you, yourself, to handle the processing.

Color Rendition is the thing which determines whether your snapshot of a barn comes out with a red suitable for a fire engine, a baby girl's bonnet, or whether it really looks like barn paint. No film can provide a perfect color match, and a perfect match isn't necessary for good pictures. A good film, however, will come so close that the difference is subtle enough to tantalize a coffee taster. Even the best films tend to render some colors more brilliantly than others.

Ektachrome film provides excellent, really high color fidelity. Its greatest brilliance is in the yellow and red end of the color scale, thus giving Ektachrome pictures a warmer appearance than Kodachrome ones which have their greatest brilliance in the greens and blues.



Kodachrome 1/50, *f*/8



Ektachrome 1/50, *f*/11-*f*/16

WORDS TO WORK WITH

EXPOSURE is the size of the lens opening (f- number) and the length of time it will be open (shutter speed). For each kind of sunlight, there's a basic exposure printed in the Ektachrome Film instructions. With bright sun and Daylight Type film it's 1/50 second at f|11. If you should cut the shutter time in half (1/100 second) for more action-stopping ability, you'll have to make the lens opening twice as large (f|8). These two pairs of settings are equivalent exposures. Every basic exposure has many useful equivalents. There's a lot more about this in the Kodak booklet, "Snapshots Exposed!"

The size of the **LENS OPENING** helps determine how much outside light will reach the film. It is marked off by numbers with f| in front of them. As you go from f|22 to f|16, to f|11, to f|8, to f|5.6, to f|4, to f|2.8, to f|2, each successive opening is twice as large as the previous one. A maximum opening of f|4.5 or f|3.5, however, is only about half again as large as the opening preceding it, that is, f|5.6 or f|4. These numbers may seem strange, but they allow the same exposure tables to fit all cameras, large and small alike.

The **SHUTTER TIME** numbers on your camera may be written as 25, 50, and 100, but actually are 1/25, 1/50, and 1/100 second. The biggest numbers, then, the briefest intervals. Shutter time is the instant during which outside light passes through the lens and hits the film. Quick shutter speeds are essential for action pictures since most action subjects move enough in 1/50 second to make a blurred image.

The **DEPTH OF FIELD** is the range of distance from your camera in which everything will be sharply focused. The size of this range depends on both the actual point of focus and the lens opening. If you focus on an object 3 feet away, the depth of field will be much shallower than if you focus on one 25 feet away, even though you use the same lens opening. When focusing on the same object, however, a small lens opening will give a much greater range than a large one.

IN-BETWEEN SETTINGS are the ones shown as f|8-f|11 or f|4-f|5.6. When you see something like this, it means to place the lens-opening scale halfway between the two numbers. On the shutter scale, by the way, in-between settings don't give in-between speeds, so it's useless to try them.

A **"STOP"** is a change in lens or shutter setting, or both, that either doubles or halves the amount of light that will get to the film. When a picture taker closes down by one stop, he would, for example, switch from f|8 to f|11 or else keep the same lens opening but cut his shutter time in half.

REVERSAL FILMS are the kind which, when processed, give you a positive on the same sheet of film that you originally exposed in your camera. Kodak Ektachrome Film is this type.



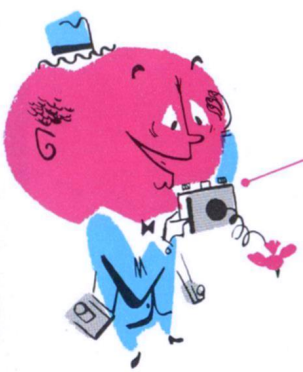

trying out a new film

When you slip a roll of some unfamiliar film into your camera, it's as smart an idea to try it on for size as it is to make sure that the sleeves of a new coat don't terminate up around the elbows and the hem isn't so long that you'll need a brace of bridesmaids to tote the train.

Kodak, of course, plants an instruction sheet in each package of Ektachrome film, and besides keeping the film from rattling around, it proclaims some recommended camera settings for the most common kinds of outdoor lighting—bright sun, hazy sun, cloudy, and open shade.

Our recommendations will probably fit your taste and your camera as neatly as a cow fits a milking machine, but it costs only five pictures to be certain.

Follow the Kodak information for all of the pictures you snap on your first roll of Ektachrome, but save the last five frames. On a bright sunny day, make five exposures of some person in a setting neither extremely dark nor light-colored. The sun should be coming from behind you. With the shutter set on 1/50 second, work the lens opening down from f/8 to f/16 in half-stop intervals.

If the pictures made according to the instruction sheet look satisfactory, you should henceforth hew to this data with unswerving devotion. If not, choose the best of the five test shots. Determine the lens opening used to make it, and merely adjust all of the Kodak daylight data in the correct direction by the difference between that opening and f/11. In fact, any time your slides are consistently light or dark, try shifting your basic exposures to compensate for the underexposure or overexposure.



under the sun

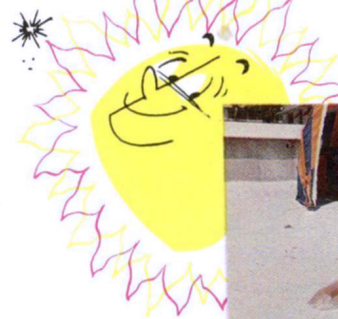

1/50, f/11

If your trigger finger has been squeezing out wonderful Kodachrome snapshots, it will probably swing over to Ektachrome with nary a twitch. It's sort of like trying out a new bike—the pedals may not be exactly where your feet are used to finding them, but the basic idea is still the same.

The only new factor that affects the calculations and manipulations you go through before pressing the button is that Ektachrome is a speed demon among color films. The problem, like that of inheriting your eccentric uncle's pet alligator, is what to do about it.

One commodity for which you might want to spend this speed bonus is extra crispness. At the standard shutter setting of 1/50 second, any jiggle or jostle of the camera will give pictures with the hazy, dreamlike quality of an oil painting that's been left out in the sun too long. Switching to a sunshine setting of 1/100 second for all your outdoor picture taking provides special insurance along these lines, particularly on windy days.

Fast shutter times not only tend to tame movement at the camera end, but also at the subject end. On a bright sunny day, an Ektachrome setting of 1/200 second at f/5.6 should freeze most action, although 1/400 second at f/4 is an even better action setting if your lens and shutter stretch that far. For a complete and nearly automatic run-down on possible lens openings and shutter speeds under

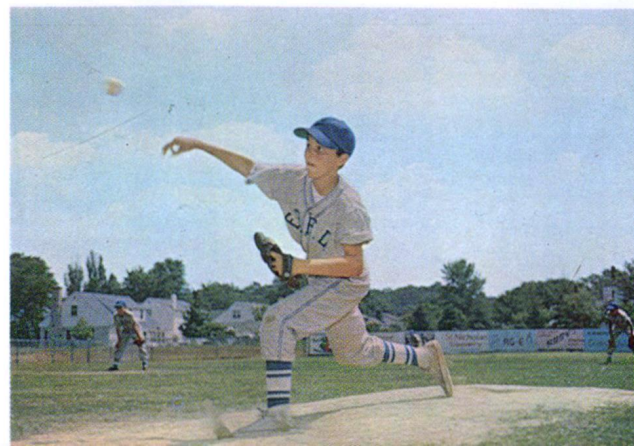

1/200, f/5.6

all ordinary outdoor lighting conditions, an inexpensive, pocket-size Kodaguide Snapshot Dial or the wider ranging Kodak Master Photoguide will save mental strain.

All exposures for sunlight picture taking can be imagined as standing on the middle rung of a ladder. For some special conditions, they have to move up a step; for others, down.

Being neither predominately dark-colored nor light-colored makes a picture subject normal. All basic exposures and their equivalents are for normal subjects, and chances are that better than 90 percent of yours will be as normal as blueberry pie. A light subject may be a person in extremely light-colored surroundings, but an extra-light one, consisting mainly of snow, sand, or white buildings, will never have people in the foreground.

When shooting close-ups of people in bright sunshine, particularly if you're planning on having prints made from your transparencies, it's vital to avoid extremely dark facial shadows. Filling them in and brightening them up is a task for a blue flash lamp. Closer than 7 or 8 feet, be sure to cover the reflector with at least one or two thicknesses of white handkerchief so that the flash won't eliminate the shadows entirely.



typical light subject

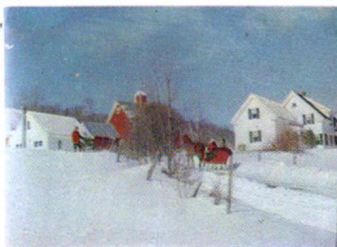

extra light subject

Everything for exploring ultra-close-up territory with your miniature camera is packed into the Kodak Close-Up Kit. Along with a frame that measures out an 8-inch camera-to-subject distance, there's a Kodak Portra Lens 5+ and a special hood, the Kodak Close-Up Flashguard, to slip over your flash holder whenever you expose by flash illumination.

Outdoors, in bright sun, you can count on an exposure setting of 1/25 second at f/16 if your subject is absolutely motionless.

Indoors, or whenever you have a subject that might move, use Daylight Type film, a No. 5B or 25B blue flash lamp, a camera setting of 1/25 second at f/22, and the Flashguard mounted so that its Swiss-cheese side is facing forward.

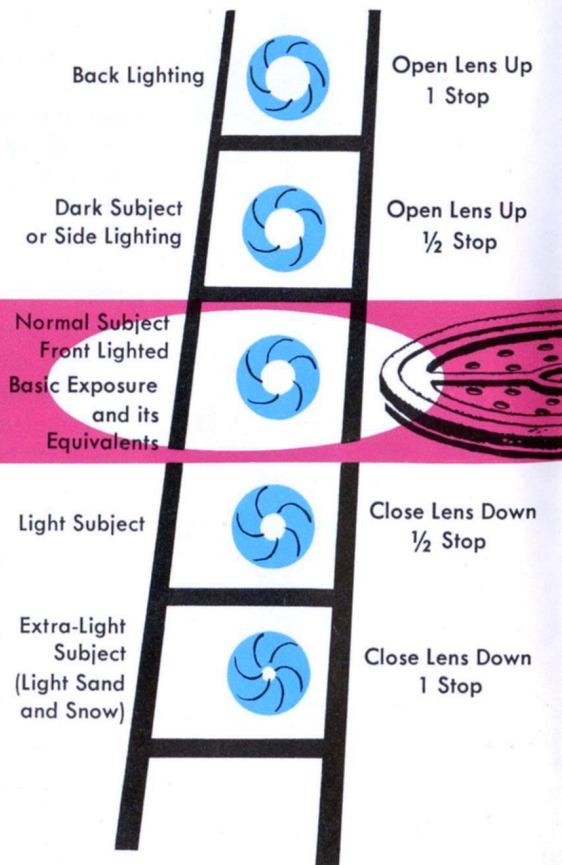
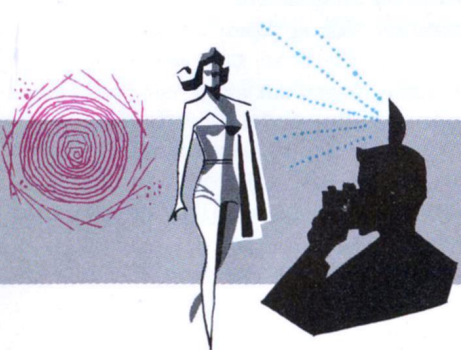

FILL-IN FLASH DISTANCES FOR CLOSE-UPS IN BRIGHT SUN

	distance (in feet)	lens opening	shutter time (in seconds)
No. 5B or 25B lamp in 4-5 inch reflector	9-15	f/11	1/50
	7-12	f/16	1/25

NOTE: Ranges rather than specific distances are given because the amount of fill-in lighting is largely a matter of personal taste, and the closer the lamp is to your subject, the greater its effect will be.

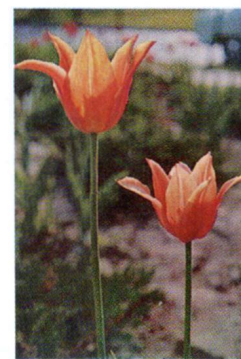
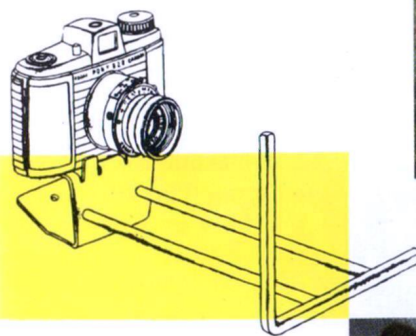

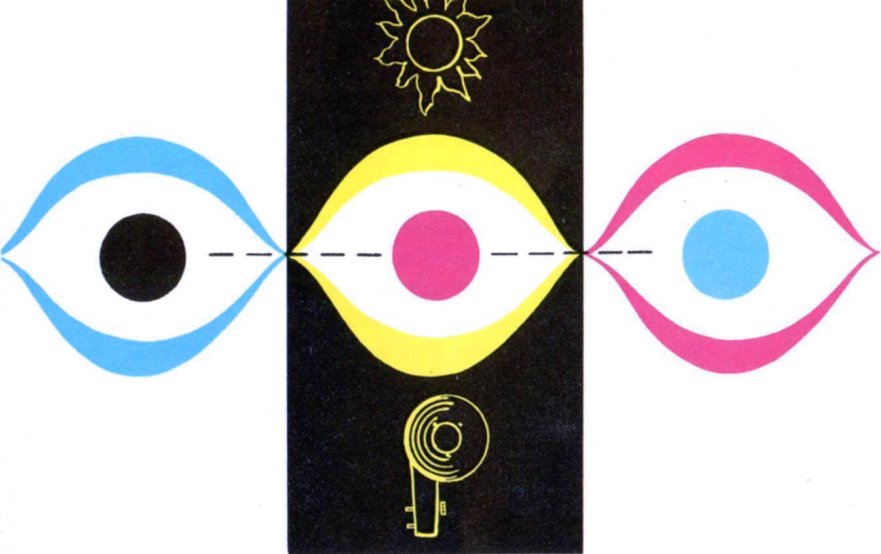

SNAPSHOTS WITHOUT SUNLIGHT

“Limited-light photography,” “available-light photography,” and “existing-light photography” are three ways of trying to pin down the same idea. It’s that light already on hand (but for which you can’t predict exposure settings in advance) yields wonderful snapshot results.

This branch of picturemaking falls into a sort of photographic nether-nether land below sunlight snapping and above flash or flood. There is, of course, quite a bit of overlapping since certain subjects can be shot by more than one technique. This is mostly a matter of choosing your own weapon and some folks always prefer a wedge to drive their ball out of the high weeds, while others depend upon a well aimed kick, delivered surreptitiously.

Correct camera settings for bright sun, hazy sun, and cloudy bright lighting are as easy to predict as the outcome of a cowboys-and-Indians shoot-em-up. But wander into your sunlit living room to click off a few fast non-flash snapshots and you’re likely to find that the 1/50 second at $f/11$ you used outdoors won’t provide an eighth of the exposure you need. At some other time of the day or at night, it may not provide even a hundredth. This difference may not be fully apparent to your eyes because they adapt so readily, but it certainly would to color film.

Generalized exposure recommendations are impossible to make when you get away from direct sunlight, because

lighting varies so widely. The Farmer’s Market in Lancaster, Pennsylvania, and the stock market in New York City are both markets, but this doesn’t assure that the same camera settings would apply in both.

Lacking some way of first finding out if there’s enough light to make pictures with your camera and then what the correct settings will be is roughly equivalent to junketing through Outer Mongolia without a road map.

In the Glass Center of the Corning Glass Works and many other sight-seeing attractions, Kodak Ektachrome Film is invaluable for making a color record of your visit. The upper left picture was shot at $\frac{1}{2}$ second at $f/2$; all the others at $\frac{1}{25}$ second at $f/2$.

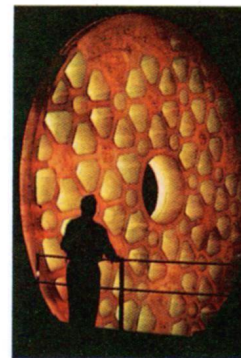

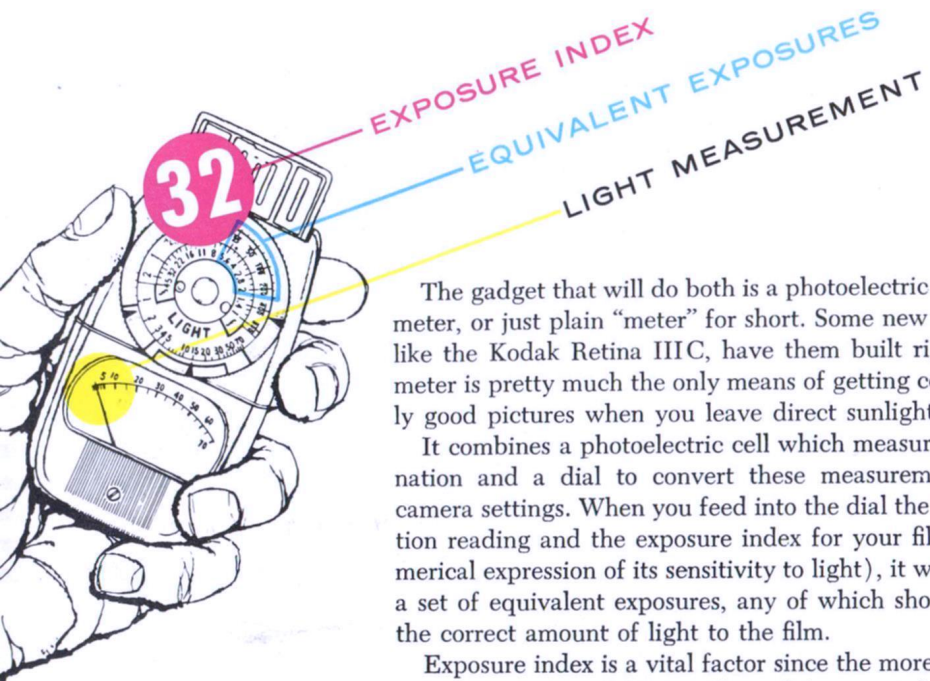

The gadget that will do both is a photoelectric exposure meter, or just plain "meter" for short. Some new cameras, like the Kodak Retina IIIC, have them built right in. A meter is pretty much the only means of getting consistently good pictures when you leave direct sunlight.

It combines a photoelectric cell which measures illumination and a dial to convert these measurements into camera settings. When you feed into the dial the illumination reading and the exposure index for your film (a numerical expression of its sensitivity to light), it will supply a set of equivalent exposures, any of which should bring the correct amount of light to the film.

Exposure index is a vital factor since the more sensitive a film is, the less light it will need for a satisfactory ex-



L 1/25, f/2; R 1/50, f/4



posure. A high exposure index, then, lets you snap pictures in a wider variety of places. *With Kodak Ektachrome Film, Daylight Type, you have an index of 32 working for you.* Shaken down to comparative terms, this makes it about three times as light-sensitive as previous reversal color films.



1/25, f/2

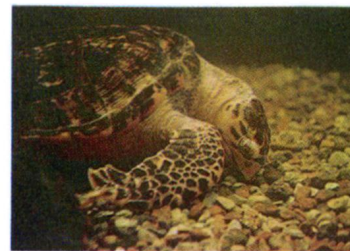

1/10, f/2

This means that, when you use Ektachrome, you'll be able to operate in only one-third as much light as your previous minimum. A setting of 1/50 second at f/2 will team up with the amount of light you'll encounter in many well illuminated stores, on brightly spotlighted stages, and within about 6 feet of a window on a gray, cloudy day.

But a meter only provides information. From there on, it's all up to you and your camera.

Steady hands and a few tricks of the trade are as useful in this kind of snapping as they are for pulling livestock out of tall silk hats. Most folks can hold a camera steady enough through a shutter time of 1/50 second to avoid any trace of camera movement in their pictures, and some can even do it at 1/25 second. It's possible, though, for almost anyone to snap away at 1/10, 1/5, or even 1/2 second by holding the camera firmly against a wall, table, fence, pane of glass, or some other stable object. A rubber jar ring makes for good non-skid contact. The ability to use these slow speeds greatly expands the range of your picture taking under dim-light conditions.

Tripods are as out of place in this kind of candid snapping as modesty is among fishermen. While going through the contortions of setting one up, a good spontaneous situation can freeze into unphotogenic self-consciousness. The Kodak Flexiclamp is a smaller, quicker substitute when one is essential.

Camera lenses also count significantly in working under difficult lighting conditions. One with a maximum opening of f/2 will be able to make a picture in half as much light as one with a maximum of f/2.8 lens, assuming that the people operating the cameras are equally adept at employing slow shutter speeds. But, the fellow with an f/3.5 or an f/4.5 lens and a bagful of tricks for holding steady at the slow speeds can shoot in even less light than the owner of an f/2 lens who doesn't have this skill.

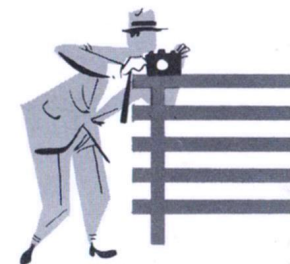

1/25, f/5.6



1/50, f/3.5

EXPOSURE METERS

and how to use them

There are two ways of measuring light. One is the incident method, reading the illumination on its way to your picture subject; the other is the reflected method, reading the light bouncing off your subject. In general, incident readings are best in dim light since hardly any surface reflects as much light as falls on it. Most modern meters are adaptable to both ways of working.

Nearly all meters come with detailed instructions, and these should be observed carefully. The tips listed here are only extremely general in nature, due to the differences between meters. If your meter instructions say anything that contradicts what you read here, stick with your instructions.

To make a reading of incident light, stand where your subject is located or in exactly the same light that falls on your subject. The light-sensitive area of the meter should be pointed halfway between the direction from which most of the light is coming and the place from which you'll be snapping. When the subject is back-lighted, however, point your meter directly toward the camera position unless you desire a silhouette.

Reflected-light readings should be made by aiming the meter toward the picture scene. For close-ups, make your reading about 6 inches from the subject's face, taking care that any bright source of light behind him doesn't influence the meter. And be sure your hand isn't creating a shadow on the area which the meter is reading. For larger areas, stand at camera position and move the meter slowly



from the top of the scene to the bottom while noting the highest and lowest readings. On overcast days, the needle will jump upward as the meter is pointed toward the sky, and this high should be ignored. In all but unusual situations, the averaging system will give reliable data.

Sometimes the light may be so dim that a meter won't give any reading at all, even by the incident method. The best bet for picture taking then is to open your lens as wide as it will go, use the slowest shutter speed possible, snap—and cross your fingers.

Daylight Type vs Type F

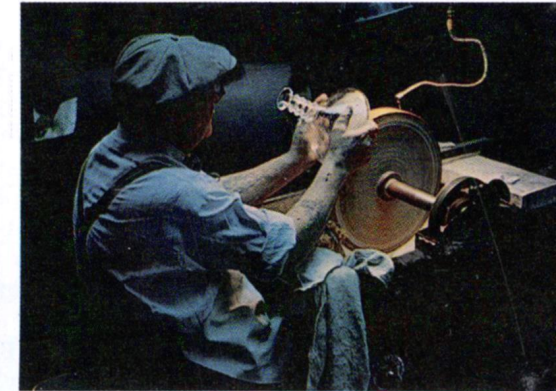
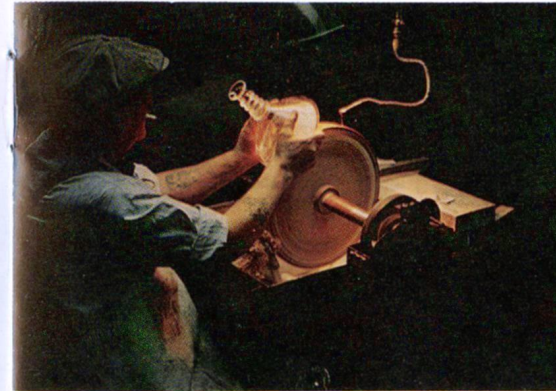

Daylight Type film is made to give the best color pictures under daylight conditions. Type F film is balanced for artificial light. So, which do you load when you're likely to encounter a combination of both, particularly if it's difficult to tell which is predominant? It's easy to say "either," and either will work, but, as you might expect, they'll give different looking pictures. The Daylight Type provides a warm-looking, yellowish transparency, while the one on Type F will lean toward the cool, bluish side. Except for personal preference along these lines, the only advantage either way is that the Daylight Type is a little more light-sensitive.

An inventor once conjured up a marvelous sheet of glass that he could look through and see everything changed into just what he wanted it to be. Five-dollar bills became five hundreds, beef stew turned into beefsteak, and even his wife began to look pretty good to him.

The poor fellow was separated from his fool's paradise via the butterfly-net route and is currently available for consultation only on visiting days.

Color films fare somewhat better. To make a picture under a kind of light other than the one for which your film is designed, chances are there's a certain Kodak Wratten Filter you can place over your camera lens for converting the wrong light to the right light.

Ektachrome Film, Type F, for example, is wedded to clear (not blue) Class M flash lamps, but by employing various filters it can go bigamous, trigamous, or even farther with numerous other kinds of flash lamps, with two types of flood lamps, and even with daylight.

Filters operate by keeping some light from reaching the film, usually more of one color than of the others. Since they differ in the amount of light they block out, each of them requires a different amount of light to make a good picture on Ektachrome. With flash lamps, the guide numbers are stated on the assumption that the proper filter is being used. For flood and daylight, the special filter exposure indexes are in the table on the next page.

The Kodak Pola-Screen is a filter of another color or, more accurately, a filter of no color at all. On a sunny day,

FILTERINGS

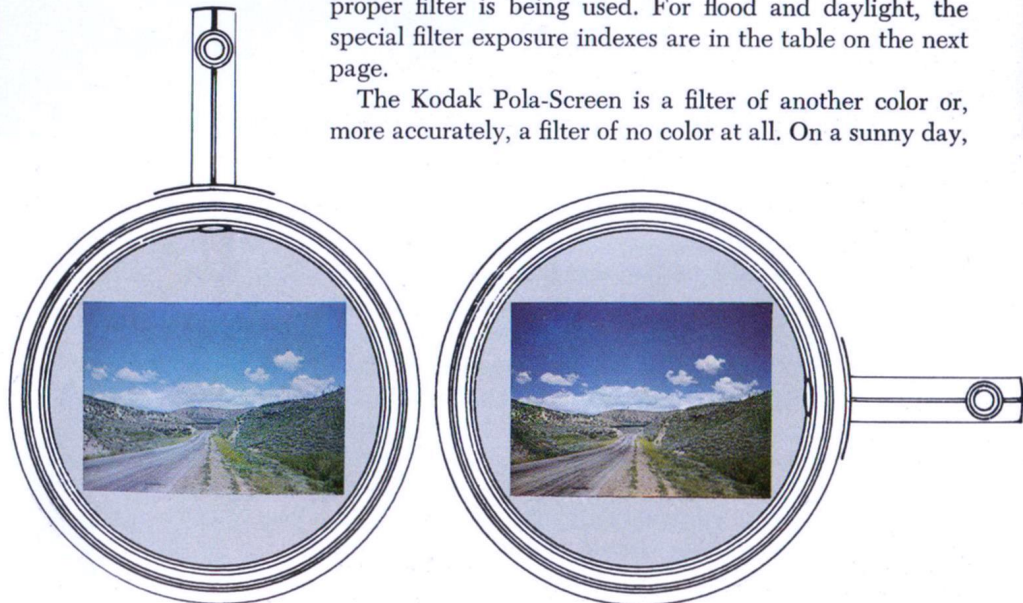

1/50, f/8-11.

1/50, f/5.6 with Pola-Screen

rotate the gray Pola-Screen slowly in front of your eye while looking at a top-lighted or side-lighted object (the Pola-Screen works only in top or side lighting); you'll see that it alters the color saturation of the sky without affecting any other colors.

Dark skies make a dramatic backdrop for scenes, pictures of flowers, trees, and buildings. When a Pola-Screen is set to do its maximum Pola-Screening, the camera lens should be open a stop-and-a-half wider than the situation would call for sans Pola-Screen. The basic Ektachrome exposure, then, in bright sunlight for an average subject is 1/50 second at f/5.6.

The Kodak Skylight Filter, by the way, often required for "warming up" Kodachrome snapshots made under bluish conditions, is needed only rarely with Ektachrome, which has a naturally warm color balance.

filter recommendations

Light Source	Daylight Type		Type F	
	Kodak Filter No.	Index	Kodak Filter No.	Index
Daylight	None	32	85C*	20
M2 Flash Lamp	No Recommendation		81	†
SM, SF Flash Lamps	No Recommendation		82B	†
Photofloods	80B	10	82A	16
3200K Photographic Flood Lamps	80B + 82A	8	82C	10

* Kodak Daylight Filter for Kodak Type F Color Films.

† Flash Guide Number Assumes use of This Filter.

one film for everything

Ektachrome Film, Daylight Type, is made to give optimum color pictures in daylight; ditto for Ektachrome Film, Type F, in most artificial illumination. Still, there are some mighty good reasons for wanting one film that will work in both even if results aren't quite so optimum, just as long as they come pretty close.

One way of doing this is with Type F film, using a Kodak Daylight Filter for Kodak Type F Color Films (Wratten No. 85C) in daylight. The daylight exposure index with this filter is 20; the basic exposure for an average subject under bright sunlight, 1/50 second at f/8-f/11.

The alternative involves Daylight Type Film and blue flash lamps for all indoor snapping. Guide numbers for these lamps are on page 21. This combination requires a stop more exposure than Type F and clear (not blue) lamps.

FLASH!

E is for Ektachrome

Type F for Flash

If you G Get the wrong lamp

You'll H have a Hash.

This fragment from the Toddler's First Book of Photography (as yet unpublished) emphasizes in its own iambic way that either no picture or a dismal version of a picture is likely to be your yield unless you're careful about selecting flash lamps.

There is an enormous variety of flash-lamp sizes and shapes—some are as big as a plump squash; other, tiny enough to crowd into a hen's egg with space left over for the yolk. They also vary in base size (a few are identical to regular household bulbs, but the midget lamps are considerably tinier), light output, flash duration, and length of time necessary to reach peak output.

Your camera probably will not synchronize with all kinds of lamps, and not all lamps will fit into your flash holder. Check your instruction manual to find out which ones you can use, and then make certain these are the kind you get.

Ektachrome Film, Type F, is balanced to give best color results with most clear (not blue) Class M lamps. Members of this class are the No. 5, 25, 8, 6, 26, 2, and 22. With any of these, there's no need for a filter.

Other clear flash lamps will also team up with Ektachrome but give first-rate transparencies only when you place the correct Kodak Wratten Filter in front of the camera lens. Filter recommendations are listed on page 17.

Shutter speed doesn't necessarily have the same significance when you use flash as it does in daylight. The most popular lamps for cameras with between-the-lens shutters are the M2, No. 5, and No. 25. The first discharges nearly all of its illumination in around 1/100 second; the other two, in a little less than 1/50. With an M2 lamp, then, you will always get 1/100 second's worth of action stopping even though you can set the shutter for a slower speed. By using 1/25 second with any of these



lamps, you allow the normal light sources in the picture area to register and provide background detail that might not be present at briefer settings.

Focal-plane shutters, integral on many precision 35mm cameras, act with flash illumination exactly as they do outdoors. The lamps made for them (No. 6, 26, 2A, and 31) throw out a relatively steady level of light over a rather long duration. Ability to freeze motion depends almost entirely upon your shutter speed.

Some lamps take longer than others to get started. The little gas-filled SM's and SF's hit peak output about 6/1000 second after you press the shutter release; the No. 5's and 25's require better than three times as long. Shutters synchronized for No. 5's and 25's are built so that they will wait a split second before opening; thus, they compensate for the lamp's delay. If you should use an SM or SF lamp with this kind of shutter, however, most of its

light might come and go before the shutter blades started to move.

Electronic flash units hurl out an extremely brief burst of light, usually 1/500 second or less in duration, and have no built-in delay. To insure that the shutter will catch all of the light, cameras on which this equipment can be used reverse the procedure set up for No. 5 and 25 lamps—first, the shutter is opened; and then the flash tube is actuated. Since the flash carries its own motion-stopping power, a long shutter speed again can be used to let ordinary lighting add some background detail.

Most electronic flash tubes emit a light almost identical in color to daylight. With a brand-new outfit, it may be necessary to use a Kodak Light Balancing Filter No. 81A for a short time, but, in most cases, the flash and Ektachrome Film, Daylight Type, will team up to give first-rate results without any kind of filtering.

The portable electronic flash outfits on the market today vary considerably in actual light output. Guide numbers for Ektachrome Film should fall somewhere between 35 and 60. If you have hit on a satisfactory one for Kodachrome Film, Daylight Type, doubling it should give you a good start with Ektachrome, Daylight Type.

To shoot an actual exposure series for electronic flash guide-number determination, snap five pictures of a typical subject at a range of 10 feet. Your lens openings should start at $f/3.5$ and work down in half-stop intervals to halfway between $f/5.6$ and $f/8$. The lens opening which gives the best transparency will, when multiplied by 10, provide a fairly accurate guide number for all of your Ektachrome picture taking.

For better picture quality than you might be able to obtain with a single conventional or electronic flash

GETTING GOOD EXPOSURES FROM GUIDE NUMBERS

1. Select a shutter speed.
2. From the table, find the guide number for that speed and the flash lamp you are using.
3. Divide the guide number by the distance from flash to subject, and use your answer as the lens opening.

source of light, try two of them. If you follow the same kind of lighting diagram shown for flood lamps on page 25, just calculate the guide number for your main light and then close the lens down a half-stop further to allow for the additional illumination added by the fill-in light.

Flash Guide Numbers for Kodak Ektachrome Films

Kodak Film	Shutter Times	Lumaclad or Polished Reflectors						
		4 to 5-inch				6 to 7-inch		
		No.	SM	No.	No.	No.	No.	No.
	Clear Lamps	8	SF	25	26	40	22	2A
Ektachrome, Type F	1/25	70	50‡	120		150	180	
	1/50	70	50‡	110	110	130	160	110
	1/100	65	45‡	95	65	110	140	65
	1/200	60	40‡	70	45	85	100	45
	Blue Lamps		5B		6B		11B	
			25B		26B		40B	
Ektachrome, Daylight Type	1/25		95		80		110	
	1/50		80		80		100	
	1/100		75		55		85	
	1/200		55		35		65	

‡ With Kodak Light Balancing Filter No. 82B

In shooting with electronic flash units, it is essential to allow enough time between flashes for the circuit to recharge fully. Data on recharging time are ordinarily listed in the instructions accompanying the unit.

Recharging time isn't a factor with conventional flash equipment, but battery exhaustion is. The delayed flash caused by batteries that have seen better days may not be evident at the time of exposure, but it certainly will be when you see your pictures. It's a good idea to replace regular batteries with a Kodak B-C Flashpack. The C end of B-C stands for condenser and this component stores energy from the battery and delivers it uniformly every time you press the shutter release. The hearing-aid type of batteries in B-C Flashpacks have often lasted as long as two years, about eight times the life of ordinary batteries.



FLASH HITS THE CEILING



Someone who aims a flash lamp anywhere but directly at his picture subject might seem heading for a miss as wide as the circus fat lady. Occasionally, though, the easiest route to first-rate flash pictures isn't necessarily the most direct one.

For instance, the light bursting out of your flash-holder reflector can be a pretty contrasty sort of photographic illumination, but the same light reflecting off a pure white (and it must be really white) matte surface will be a soft, diffused, and thoroughly pleasant kind that's extremely flattering to most flash subjects.

Merely make that white surface a ceiling, aim the flash so it bounces off the ceiling onto the subject, and it isn't difficult to see why the long way around might turn out to be the best one. Actually, some transparencies shot in this manner with a single lamp have a quality that would be difficult to duplicate even with as many as three or four lamps used as direct lighting.

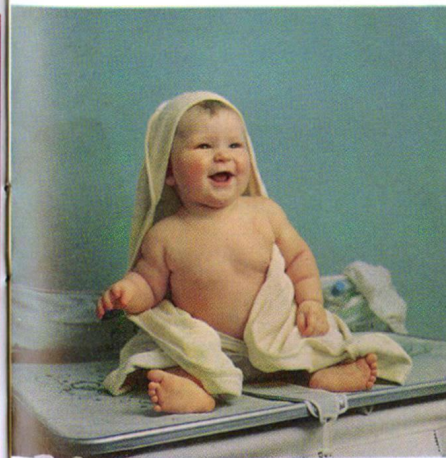
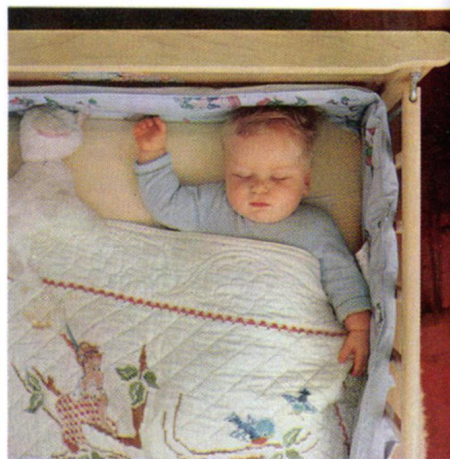

The only special paraphernalia needed are a Kodak Flashholder 20-foot Extension Cord and a Kodak Flexi-clamp, together, a cash drain of less than ten dollars. While you can get good results without this extra equipment by merely bouncing the flash from camera position, exposures are more difficult to determine since they vary depending on camera-to-subject distance.

Since some items which influence exposure settings for bounce-flash snapping (things like the reflectivity of the white ceiling and the size of the room) will always be beyond the control of the photographer, it's extremely helpful to standardize on whatever else you can. Three good possibilities are:

1. *Distance from flash to ceiling:* If you mount the Flexi-clamp and flash holder to the back of a chair, they will be about the right distance from a normal ceiling to give excellent lighting. Make sure, though, that you don't place the chair near a colored wall.



2. *Distance from flash to subject:* A range of about 8 feet, unless you're trying to photograph a fairly large area, offers a pair of advantages. First, the lens opening likely to give good results will probably be small enough to provide a wide range of sharp focus; second, the angle between flash and ceiling will be around 45 degrees, and this permits some light to spill directly from the reflector onto the subject, creating desirable highlights. This 8-foot distance

won't affect your snapping distance since you can wander freely at the end of your 20-foot tether.

3. *Shutter speed:* Settling on 1/50 second takes advantage of nearly all the flash-lamp's light output and, with a No. 5 or 25 lamp, its action-stopping potential, too.

A simple exposure series of five shots will tip you off as to the best lens opening. With a No. 5 or 25 lamp for between-the-lens shutters and a No. 6 or 26 for the focal-plane variety, start at *f*/5.6 and work down in half-stop intervals to *f*/11. When their ceilings are the same white, you'll probably find that a large room will demand a half-stop more exposure than one about 10 by 12 feet.

There are two ways of rocking this bounce-flash dreamboat, so before you climb aboard make sure you always have the flash hitting the ceiling out in the middle of the room. Otherwise, it's liable to pick up some color from a wall. And shoot from somewhere near the line from flash to subject. Only heavy shadow areas will contain a hint of the wall color, and front lighting will eliminate these deep shadows almost entirely.



HANDLING A FLOOD

Photofloods can be funny—not “funny ha-ha” but “funny strange.” While terrifically bright-looking when you use a few of them in your living room, a No. 2 reflector-type photoflood as close as 4 feet actually provides only about 1/12 as much picture illumination as bright sunlight.

Shooting Ektachrome Film by photoflood generally involves either a wide lens opening, a fairly long shutter speed, or both.

Flat lighting is usually best to start with. This is the kind that covers the camera's view of your subject pretty evenly. It involves setting your main light and your chief fill-in light the same distance from the subject and about 45 degrees apart, with the camera somewhere between them.

Other lighting setups can be employed for various dramatic effects, but they require considerable care. Under any circumstances, correct exposure information is easiest to obtain with an exposure meter used as recommended in its instruction booklet. *The exposure index for Ektachrome Film, Type F, with a Kodak Light Balancing Filter No. 82A is 16.*

For home picture taking, the No. 2 reflector-type photoflood or photospot offers the important advantage of having an efficient reflector built directly into the globe housing.

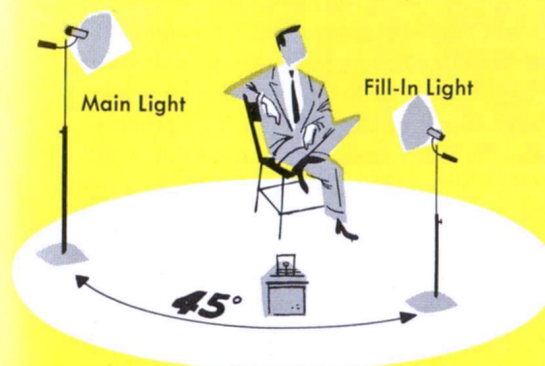

2 RFL-2 Photoflood Lamp.

FLOOD LAMP SETTINGS:

Lamp to Subject Distance	Basic Exposure Type F Ektachrome No. 82A Filter
4'	1/25, <i>f</i> /4
7'	1/25, <i>f</i> /2.8
9½'	1/25, <i>f</i> /2

A complete Flood Light Computer is included in the Kodak Master Photoguide.

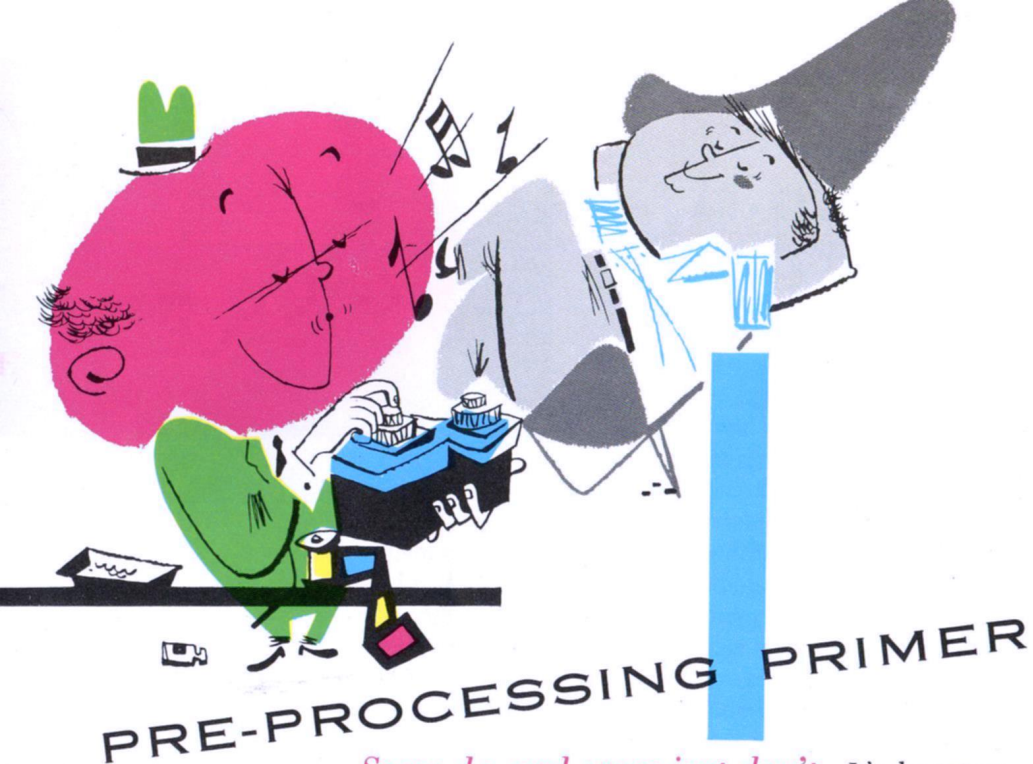

PRE-PROCESSING PRIMER

Some do, and some just don't. It's the nature of the beast.

If you're a do-er and one of the things you're thinking about doing is your own Ektachrome processing, here's a capsule rundown on what it involves.

For the 35mm size, your total investment (the equipment recommended on pages 27 and 28) need not amount to more than \$25. Each 1-pint kit of chemicals carries a list price (at this printing) of \$1.80 and will safely accommodate six rolls of 35mm film, making the chemical outlay per roll \$.30. This will be a trifle lower for 828 film, somewhat higher with the other roll sizes. The cost of 20 cardboard mounts will range between about \$.25 and \$.75.

From the time standpoint, once you've mixed your chemicals and brought them to the correct temperatures (around a half-hour's worth of effort), the actual processing cycle demands an hour and ten minutes of your presence.

With 35mm Ektachrome and a Kodak Day-Load Tank you can labor entirely in room light. Other sizes and other equipment require complete darkness at least during the period in which you load the film into your tank.

Nothing in the Ektachrome processing routine calls for more than two hands, and nothing involves special experience. Satisfactory equipment, a kitchen sink, and close attention to the instructions are all you'll need.

PROCESSING EQUIPMENT



It takes the right tools to do the job. For this particular job, the tools are:

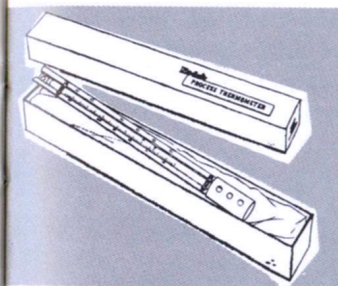

An accurate thermometer. Accuracy here slices down to a sliver of $\frac{1}{2}F$, the maximum amount you can stray from the aim point of 75F needed with the Ektachrome First Developer. This is a good deal more critical than the requirements of most black-and-white processing. Trying to work in the confines of $\pm\frac{1}{2}F$ with a thermometer of questionable accuracy is like trying to time a 50-yard dash with an hourglass.

Recommendation: The Kodak Process Thermometer. It is especially made to provide the kind of accuracy needed for Ektachrome processing. While a bit more expensive than ordinary photographic thermometers, it's definitely a worthwhile investment.

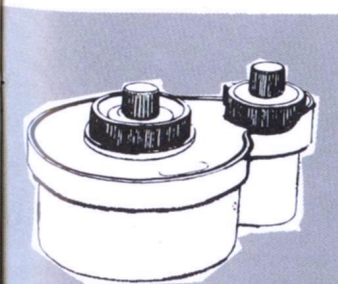

A satisfactory tank. Any tank used in Ektachrome processing must have a reel with either a transparent end or one that is at least 50 percent open area so that sufficient light can reach the film during its reversal exposure.

Recommendation: For 35mm Ektachrome, the Kodak Day-Load Tank—for other sizes, the Nikor tank or some similar type. The Day-Load Tank empties quickly, can be loaded in ordinary room light, and permits you to keep constant track of solution temperature. There are Nikor tanks which allow you to process more than one roll of film at a time, a tremendous convenience.

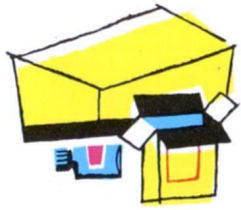

An Ektachrome Processing Kit. These kits contain all the components and step-by-step instructions for mixing the six Ektachrome processing solutions. Available sizes are 1 pint, ½ gallon, and 3½ gallons.

Recommendation: The 1-pint kit for folks who'll be processing their film one roll at a time; the ½-gallon size for those with multiple-roll tanks. A pint of solutions has a capacity of six 20-exposure rolls of 35mm Ektachrome, ten rolls of 828, and three rolls of 120 or 620.



Six glass bottles. Any drugstore or chemical supply house should be able to supply these in the same size as the capacity of processing kit you will be using.

Recommendation: Brown rather than clear bottles. The brown glass will prevent any damaging effect that bright light might cause to the two developers. Either make certain that the bottle caps seal tightly or obtain some rubber stoppers.

A tray. Immersing the film tank in a tray of water held at the correct solution temperature is a good way to keep the processing solutions at that temperature.

Recommendation: A tray about an inch shallower than your tank so that you can run water into it without any fear that the water will overflow into the tank.

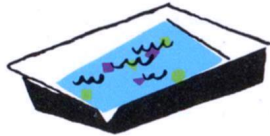

A reversal exposure lamp. Step 4 in the processing cycle calls for the film to receive a 15-second exposure about a foot away from a No. 2 photoflood.

Recommendation: The lamp mounted so that the film will not be directly over it when you give the reversal exposure. Any liquid that might drip onto the lamp surface would be likely to shatter it.



mixology

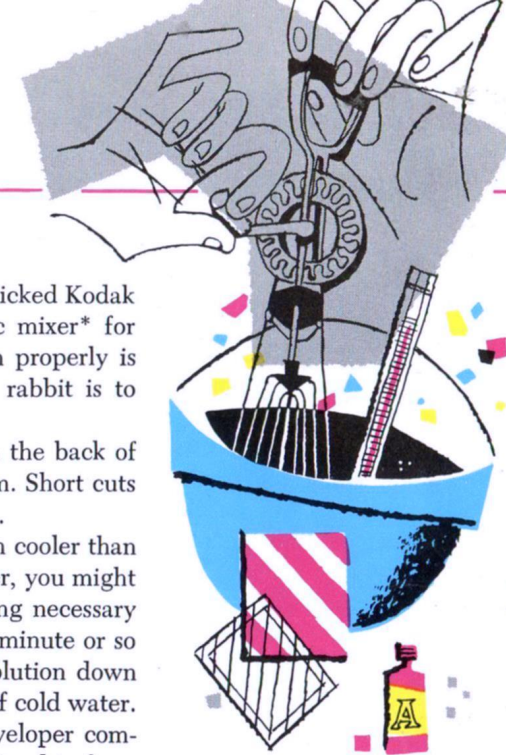

Whether you're an eggbeater* man, wield a wicked Kodak Stirring Paddle, or confiscate Mom's electric mixer* for the job, getting your chemicals into solution properly is as essential to good processing results as a rabbit is to rabbit stew.

Complete mixing directions are printed on the back of each Ektachrome Processing Kit. Follow them. Short cuts may turn out to really be the long way home.

If, for example, you should use water much cooler than the recommended 90F for the First Developer, you might literally go stir crazy from all the extra mixing necessary to get the powders dissolved. It takes only a minute or so and no considerable labor to bring a 90F solution down to 75F merely by placing the bottle in a pot of cold water.

Special care should be taken in Color Developer compounding. The liquid in the small bottle will tend to form clear droplets on the bottom of your mixing vessel, and unless these are completely stirred into solution, your slides will have a definite pinkish cast.

It's also mighty important to rinse mixing equipment so that one solution won't contaminate another. This is particularly vital after compounding the Bleach, since it can corrode most metals.

**Beware of using any metal mixing device or container not made of stainless steel; otherwise, there is possibility of corrosion.*

COLORS of properly mixed solutions

	AFTER MIXING	AFTER USE
First Developer	clear and almost colorless	slightly darker
Hardener	clear and dark blue	no change*
Color Developer	cloudy and deep orange or red	no change
Clearing and Fixing Bath	clear and colorless	greenish-yellow
Bleach	clear and deep yellow	cloudy, with silver deposit on bottom of container
Stabilizing Bath	clear and colorless	no change

**Any appearance of greenishness indicates that the Hardener has been contaminated and should not be used any further.*

STEP BY STEP

Temperature Control: The First Developer is the lone solution that demands pinpoint pampering. If its temperature sneaks down below 74½F, transparencies go greenish and flat; up above 75½F, the shift is pink-ward. Keeping your tank snugly ensconced in a tray of water held at 75F for the entire processing cycle helps avoid temperature fluctuations.



Agitation: Treating all rolls of film alike insures that their colors will look alike. With all solutions, agitate continuously for the first 15 seconds; then, 5 seconds every minute. To shake air bubbles off the film, tap your tank lightly on a table top at the very start of First Development.



Handling: Don't. Neither touch the film nor unreel it at any time during processing. Hands off during drying, too. Don't prolong reversal exposure—the heat can soften the film emulsion.



SUMMARY OF STEPS

STEP	SOLUTION OR PROCEDURE	REMARKS	TEMP. IN F	TIME IN MIN.	TOTAL MIN. AT END OF STEP
1	First Developer	Temperature tolerance ± ½F	75	10	10
2	Rinse	Running water	73-77	1	11
3	Hardener	Room lights can be turned on after 3 min. and reversal exposure started.	73-77	3-10	14-21
4	Reversal Exposure	Expose each side of film for 5 seconds or each end of reel for 15 seconds at 1 foot from a No. 2 photoflood. Return films to hardener solution until all have been re-exposed.			Reset Timer to Zero
5	Wash	Running water	73-77	3	3
6	Color Developer		73-77	15	18
7	Wash	Running water	73-77	5	23

Rinsing: Never short-cut on rinse time. If you do after First Development, a white scum will be left on the film. The Kodak Day-Load Tank permits use of running water for rinsing. With other tanks, make sure that a 1-minute rinse includes at least three fillings and emptyings.



Cleaning: If you pour all of your solutions into the tank from the same container, wash the container thoroughly between steps to avoid contamination.

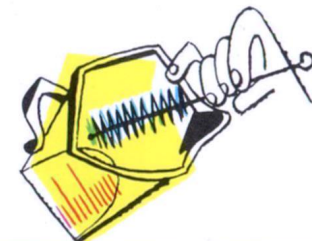

Drying: Hang wet film up in the most dust-free possible location. Anything that lodges in the wet gelatin will be a permanent guest. You may wipe the base side of the film to speed drying, *but never the emulsion*. When wet and viewed by reflected light, the base will be blue, the emulsion yellow-brown.



Mounting: 35mm and 828 transparencies can be housed in cardboard Kodak Ready-Mounts. Folded ones come 50 to a package; the unfolded variety which can be sealed with an iron, 100. For more de luxe accommodations, the Kodak Slide Kit has glass, masks, stickers, and tape enough for 50 slides. Mounting materials and clear acetate sleeves for larger film sizes are made by folks other than Kodak but may usually be obtained from Kodak dealers.

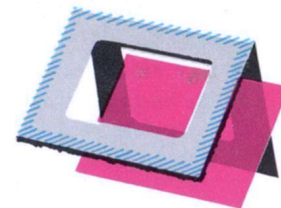

for Kodak Ektachrome Processing

STEP	SOLUTION OR PROCEDURE	REMARKS	TEMP. IN F	TIME IN MIN.	TOTAL MIN. AT END OF STEP
8	Clear	Save bath for use in Step 12	73-77	5	28
9	Rinse	Running water for not less than 30 sec. or more than 90 sec.	73-77	1	29
10	Bleach	See warning on label	73-77	8	37
11	Rinse	Running water	73-77	1	38
12	Fix	Clearing and Fixing Bath	73-77	3	41
13	Wash	Running water	73-77	8	49
14	Stabilizing	Stabilizing Bath	73-77	1	50
15	Dry	Same method as black-and-white films (110 F temperature limit)			

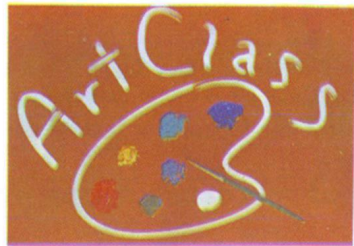

SIGNPOSTS FOR SLIDE SHOWS

Transparencies are made to be shown, usually shown off. Only the most misanthropic camera bug would, like a winter-wary squirrel, cache his slides away for solitary enjoyment.

Good pictures deserve a good showing. One handsome way of assuring this is with some well engineered title slides to smooth transitions, serve as photographic punctuation, and deter audience fatigue with an extra touch of variety. You can:

Shoot them on location: Close-ups of street signs, road signs, historical markers, and billboards are fine for this purpose. The more colorful they are, the better. Snap from as near as you can so that the text will be legible.

Do your own typesetting: If you have a Kodak Close-Up Kit, just spell out your title with raised plastic letters, anagrams, Scrabble squares, or some similarly small, handy kind of type. You can arrange them on sheets of matte-surface colored paper (shiny paper may cause annoying reflections) and expose either by flash or sunlight.

Get into it with both hands: The medium, here, is finger paints. Work with them on a 16 by 24-inch sheet of glass. You can add solid objects, such as pine cones, flowers, and travel souvenirs, to your hand-painted masterpiece. For photographing, lay the glass on the ground in bright sunlight with a sheet of white or colored paper beneath it. To fill the picture area of a 35mm frame, use a camera-to-subject distance a whisker less than 3 feet if the focal length of your lens is 44 mm; around 3¼ feet if the focal length is 50 mm.

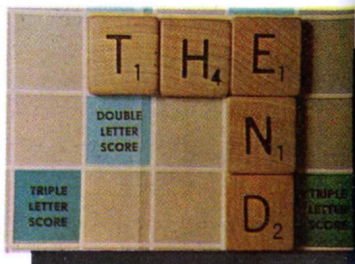

LOOSE ENDS

at $\frac{1}{50}$ shutter speed set lens at opening indicated by lighting condition.

● Lens openings are for average subjects front-lighted in sunlight conditions. Light subjects may need an adjustment to a half a lens opening smaller. When the subject is side or back lighted, adjust to a half a lens opening larger. When closeups are back-lighted, use a full lens opening larger.

To form the Pocket Guide, tear along perforated edge and fold at scoring

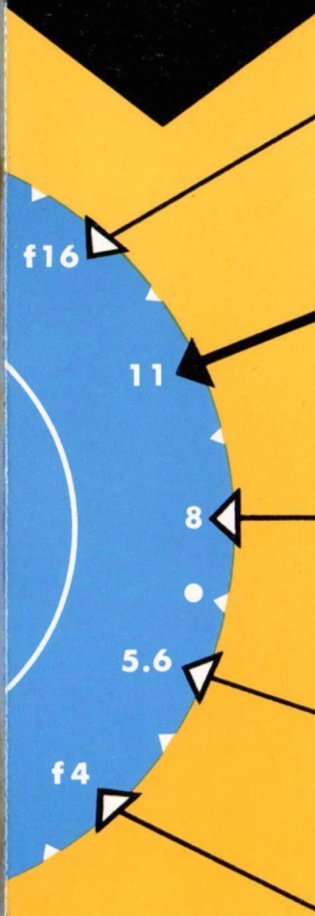

BRIGHT SUN ON SAND OR SNOW



The sky is clear. Surroundings are light in color and reflect light strongly. When subjects are near camera, increase the lens opening one half stop—between $f/11$ and $f/16$.

BRIGHT SUN



A bright sun, clear sky condition in the more common surroundings comprised of approximately equal areas of light, average, and dark color. Shadows tend to be dense.

HAZY SUN

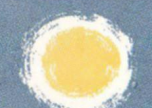

The sun's disk is bright but is softened by a thin overcast that diffuses the light. You can look at the sun without much discomfort. Shadows are light and soft in outline.

CLOUDY BRIGHT



The sky is bright but is overcast with white clouds. The sun's disk is obscured, and there are no shadows. There must be plenty of sky overhead and in front of the subject.

OPEN SHADE



The sun is shining but the subject is shaded from the sun by a nearby large object. Subject must be lighted by a wide angle of clear, unobstructed sky overhead and in front.

EASTMAN KODAK COMPANY
Rochester 4, N. Y.
E-37 8-55-GL PRINTED IN U.S.A.

also a non-automatic version which stacks slides into a receiver in the exact order of projection.

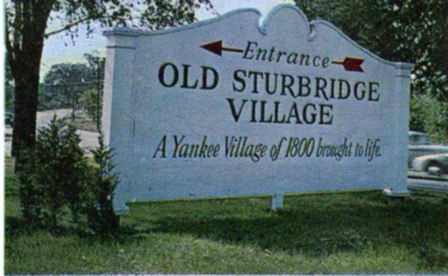

LOOSE ENDS



PROMPT PROCESSING

• High humidity plus high temperature adds up to trouble for photographic film, particularly after exposure. With color film, these conditions can alter the normal color balance. By having your Ektachrome Film processed as soon as possible, you'll side-step most of this problem. When planning a trip either in this country or abroad, make arrangements with your regular dealer so that you can mail exposed film to him and he can hold the completed transparencies for you until your return.



PROTECTION

• All Ektachrome Film is sealed against the intrusion of outside humidity. But it isn't heat-proof, too. Keep film or a loaded camera out of any place where high temperatures are likely to build up. Two danger spots in an automobile are the shelf behind the rear seat and the glove compartment. In tropical climes and summer heat waves, a safe storage place is the bottom shelf of a refrigerator. When you take out a roll of film, let it reach room temperature before you actually load it into your camera.

PROJECTION

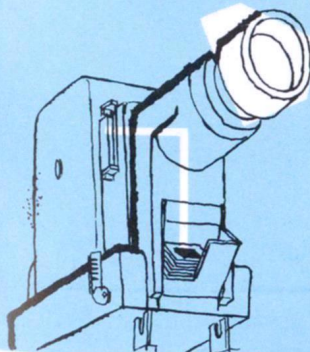

• For sparkling home screenings of 35mm and 828 slides, the nonpareil of projectors is the Kodaslide Signet 300, Model A. Its brilliant light output is spread evenly across the screen so that the corners of your slides are as well illuminated as the other areas. The blower in the Signet 300 is of an unusual impeller type. It provides top-efficiency cooling without being noisy about it. There's an automatic version of this projector and also a non-automatic version which stacks slides into a receiver in the exact order of projection.

To form the Pocket Guide, tear along perforated edge and fold at scoring

FLASH



POCKET EXPOSURE GUIDE

Ektachrome

SNAPSHOT EXPOSURE

DAYLIGHT



FLASH EXPOSURE

• The lens openings in the table are based on a shutter speed of 1/25 second. The row of figures in the diagram are labelled in feet. They represent distances from flash lamp to subject. Opposite each listed flash lamp is a series of lens opening numbers which are related to the scale of distances. The vertical blue lines are distance lines and aid in finding the approximate lens opening to use at any of the distances.

Example: When a No. 8 lamp is used to light a subject 12 feet from the lamp, the diagram shows that the lens opening should be $f/5.6$.

CLEAR LAMPS		DISTANCE IN FEET								
		2	4	6	8	10	12	14	16	
Type F Film	No. 8*	$f/22$	16	11	8	5.6			4	
	No. 5, 25*		$f/22$	16		11			8	
	No. 5M, SF†	$f/16$	11	8		5.6	4	3.5		
	No. 2, 22††			$f/32$	22		16			11
BLUE Daylight Type	No. 5B 25B*	$f/22$	16	11		8			5.6	

*4- to 6-inch polished reflector.

†4- to 6-inch polished reflector; Kodak Wratten Filter No. 82

††6- to 7-inch polished reflector.

Eastman Kodak Company • Rochester 4, New York

Kodak Ektachrome Film
Kodak Publication No. E-13

PRINTED IN THE UNITED STATES OF AMERICA

10-55L-GLP