

Canon 8 EEE

MOTOR ZOOM

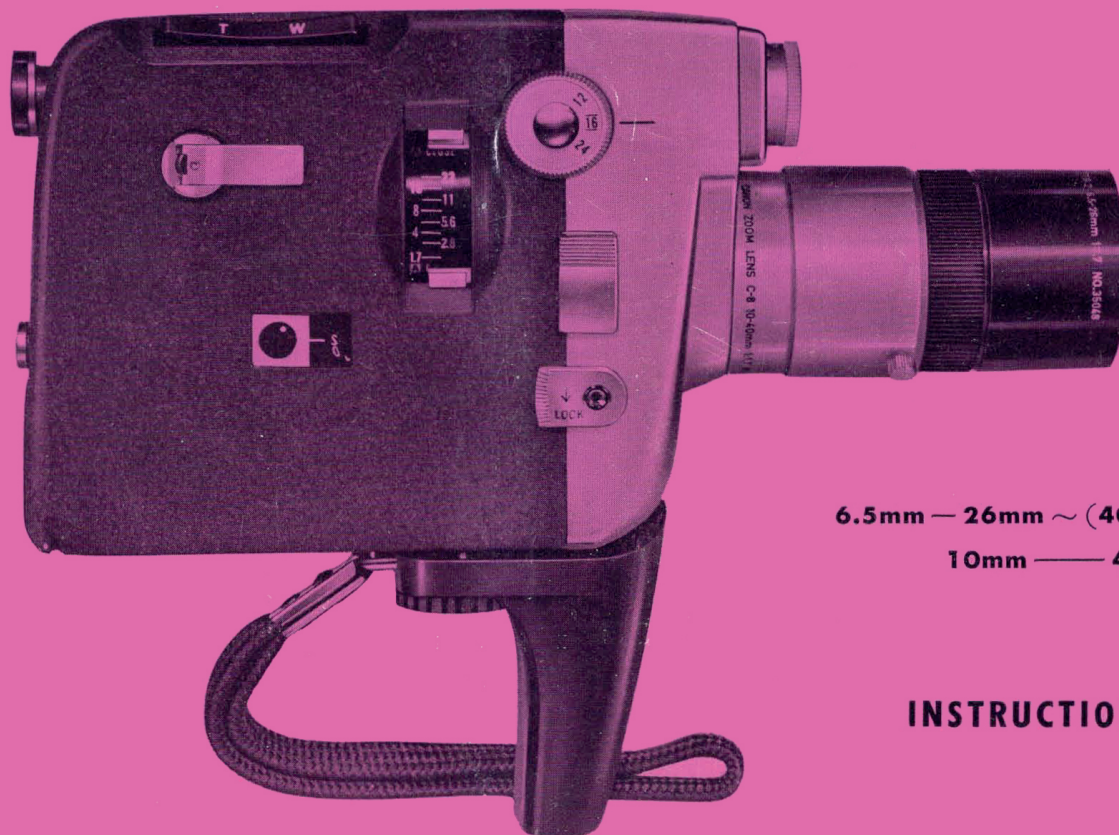

6.5mm — 26mm ~ (40mm) **F1.7**
10mm — 40mm

INSTRUCTION MANUAL

We extend to you a hearty welcome to the world-wide family of Canon photo equipment owners. And we thank you for choosing the Canon Motor Zoom 8 EEE for your future motion picture enjoyment. We are confident that you will find your new investment very worthwhile.

In your possession is a camera which marks another important milestone in the more than 25-year history of the Canon Camera Company.

This is one of the most feature-laden quality 8mm motion picture cameras in existence today. Let us list a few:

1. Electric Motor Drive powered by 4 penlight batteries.
2. Cadmium Sulfide "CdS" Electric Eye and Manual system.
3. Six times zoom range: 6.5mm-26mm with attachment.
10mm-40mm without attachment.
4. Sharp, fast Canon 12-element, F1.7 zoom lens.
5. Motor powered zooming.
6. Adjustable viewfinder eyepiece.
7. Rewind for lap dissolve.
8. Reflex, through the lens viewing.
9. Split-image rangefinder.
10. Canon quality finish throughout.

A new world of motion picture enjoyment will be opened to you if you will begin by following carefully the instructions contained in this booklet.



EXTERIOR DESCRIPTION OF CANON MOTOR ZOOM 8 EEE

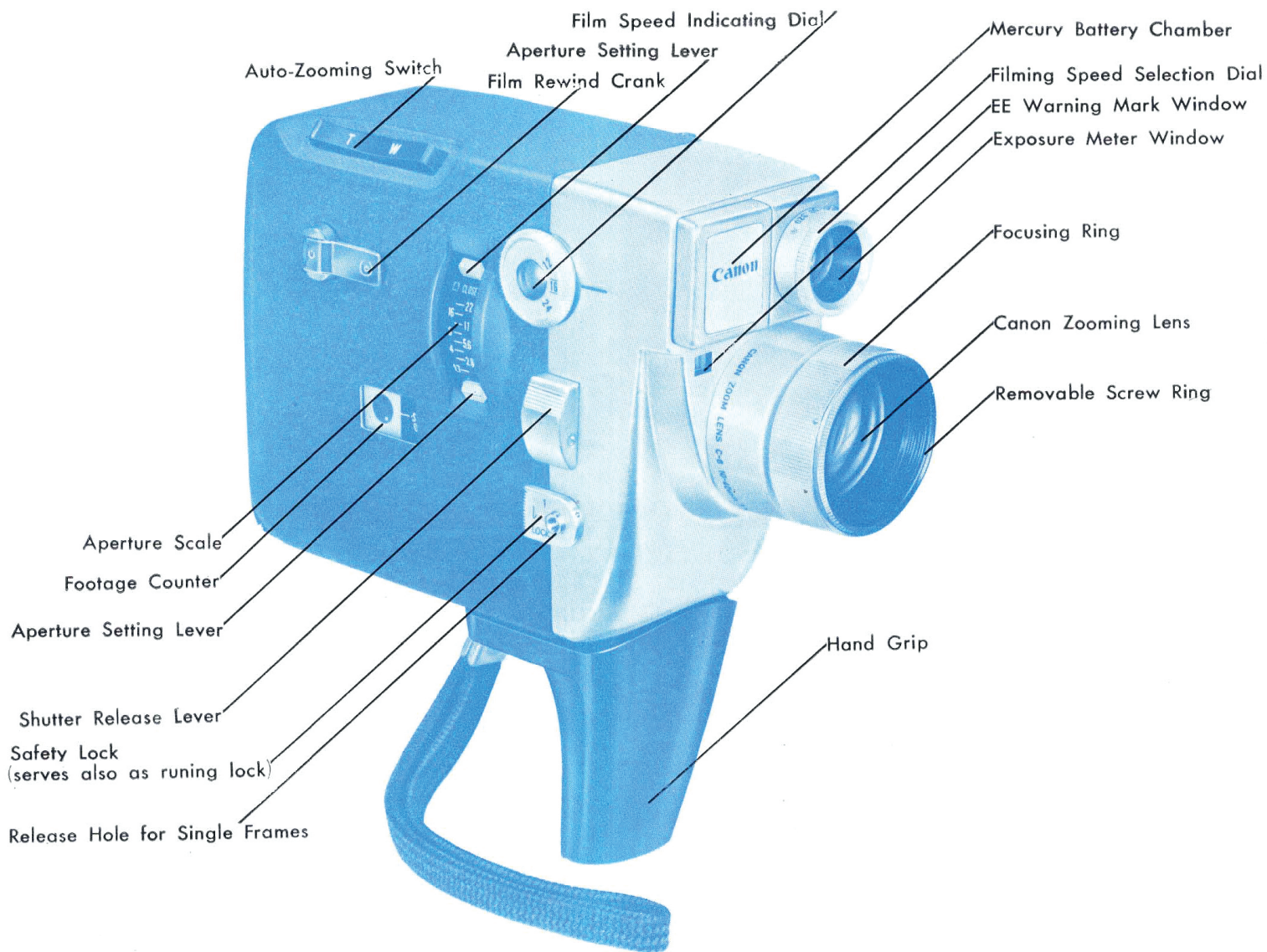

Fig. 1 View of Control Panel Side

MAJOR FEATURES OF THE

1. Unique Zoom Lens

This lens has an unrivaled speed of F1.7 and four-time zoom range from 10mm to 40 mm. This is extended to include the focal lengths of 6.5mm to 26mm with the use of a wide angle attachment. And the climax of such versatility is the consistent, unwavering focus you obtain from one end of the zoom scale to the other. These hitherto incompatible technical features were harnessed into this miracle lens by an exclusive and patented design. This lens combines the capacities of 6X zoom and, with the wide angle converter, as many as eight individual lenses.

2. Ultra-Precise Electric Eye Mechanism

Cinematography at consistently accurate exposures has been made possible by incorporating an Electric Eye system coupled to a highly sensitive Cadmium Sulfide Exposure Meter. This meter will adjust to film indexes from ASA 5 to 320 (DIN 8 to 26). The meter sensitivity ranges from LV 6.5 to LV 14.4 for an ASA 100 or DIN 21 film. As an additional safeguard in picture taking, a warning light window has been provided in the viewfinder. Correct Exposure range is indicated by a blue light. A red light shows if there is too much or inadequate illumination for the film in use. The CdS meter is activated by a replaceable 1.3 volt mercury battery (National M-N type), available in many countries.

3. Motor Zoom and Film Advance

The motor zoom and film advance can be operated independently because they are powered by two separate micromotors. Four 1.5 volt UM-3 (penlight) batteries are used as a power source for both. The 10mm to 40mm zoom range can be covered in 3.5 seconds. Manual zoom is also possible.

4. Frame Speed

Four frame speeds are possible, 12, 16, 24 frames per second and single frame.

5. Lens Aperture Control

The photographer has a wide choice of controls: 1. Automatic, for full aperture range from F1.7 to F22. 2. Manual, for full aperture range. 3. By closing the gap between the scales on the aperture dial the functioning range of the electric eye system can be intentionally limited, an exclusive with the Canon Motor Zoom 8 EEE.

CANON MOTOR ZOOM 8 EEE

6. **Single Lens Reflex Viewfinder**

You are able to see what you are actually taking, through a complex optical maze of rare earth lenses. There are 12 elements in the lens and another 12 in the viewfinder system. You are always viewing with the lens wide open and without flicker, no matter what the aperture setting, as the image is deflected into the viewfinder in front of the diaphragm and shutter.

7. **Split-Image Rangefinder**

In addition to ground glass focusing a split-image rangefinder has been built-in for critical photography.

8. **Automatic Footage Counter Re-set**

The Canon Motor Zoom 8 EEE automatic re-set is a two-part operation. First open the camera cover and then the film gate to activate the mechanism. This permits you to open the camera in the middle of a run to inspect the film advance with the counter remaining stationary, a Canon exclusive.

9. **Film Rewind**

This permits a rewind of the exposed film for intentional double exposure or lap dissolve photography. The film counter also is reversed to prevent disruption of accurate footage count to the end of the roll.

10. **Easy Loading**

Sprocketless, easy loading is provided for fast and safe film change.

11. **Single Frame and Continuous Exposure**

Special sockets are provided for single frame exposures by pressure of the shutter button, and use of a cable release. Continuous run is possible by locking the shutter release button and in the advance position, use of a cable release or remote control cable.

12. **Accessories**

Only a few accessories are provided for the Canon Motor Zoom 8 EEE as so many are actually built into the body. They are the handgrip, remote control box, wide angle converter, close-up lens and replacement mercury batteries.



FACTS ABOUT THE 8MM MOTION PICTURE FILM

- A roll of 8mm motion picture camera film is actually sold in rolls 16 mm wide by 7.5 meters (25 feet) long, with extra lengths for leader.
- On the first 7.5-meter run only half the width of the film is exposed and the other on the second or return run.
- When the roll is sent for processing the film is split into two 8mm strips and spliced into a single 15-meter (50 feet) 8mm roll before being returned to the customer.
- A reversal development converts the 8mm roll into a positive picture film.
- The running time of an 8mm film 15 meters long is approximately 4 minutes.

FACTS ABOUT ELECTRIC EYE AND ELECTRIC EYE PHOTOGRAPHY

- The Canon Motor Zoom 8 EEE assures you correct exposure under varying light conditions through the operation of the automatic diaphragm coupled to a Cadmium Sulfide (CdS) exposure meter.
- Perfect exposure is obtained by simply pressing the shutter release button and focusing through the reflex viewfinder.
- This freedom permits the photographer to add special effects such as fade-in, fade-out and lap dissolve.

CONTENTS

HOW TO USE YOUR MOTOR ZOOM 8 EEE

GENERAL PROCEDURE FOR ELECTRIC EYE PHOTOGRAPHY	9
PREPARATIONS FOR ELECTRIC EYE PHOTOGRAPHY	10
Setting film index, aperture control levers, and words of caution.	
ACTUAL ELECTRIC EYE PHOTOGRAPHY	13
Adjustment of eyepiece, automatic and manual zoom controls, use of split-image rangefinder.	
HOLDING THE CAMERA & ATTACHING HANDGRIP.....	14
LENS APERTURE CONTROL LEVERS.....	16
Automatic, manual and limited electric eye operation	
FADE-OUT, FADE-IN AND OVERLAP (Double Exposure) OPERATIONS.....	19
FILM LOADING PROCEDURE	23
RELOADING & UNLOADING PROCEDURE	24
REPLACING EXPOSURE METER MERCURY BATTERY CELL AND PENLIGHT BATTERIES	25
REMOTE CONTROL DEVICE, BATTERY CHECKER AND NEUTRAL DEN- SITY FILTERS	27
CANON WIDE ANGLE ZOOM CONVERTER LENS	29
Procedure for attaching	
OTHER ACCESSORIES	30
Filters, 34mm Close-up Lens, Canon Projector P-8, Titling Stand	
WORDS OF CAUTION AND MAINTENANCE RULES.....	32

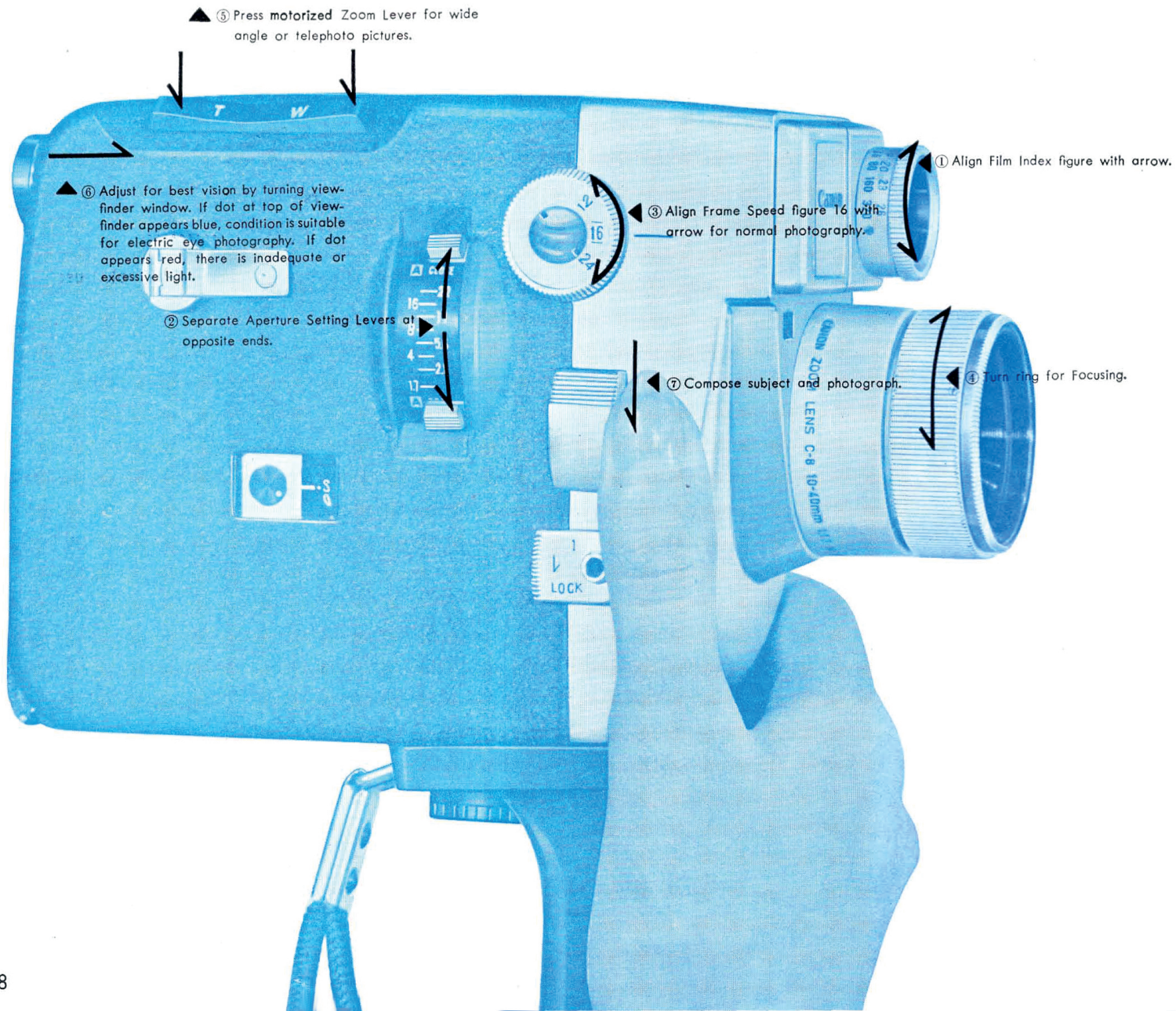

PROCEDURE FOR ELECTRIC EYE PHOTOGRAPHY

1. Align Film Index figure with arrow.
2. Separate Aperture Setting Levers at opposite ends.
3. Align Frame Speed figure 16 with arrow for normal photography.
4. Turn ring for Focusing.
5. Press Automatic Zoom Lever for wide angle or telephoto pictures.
6. Adjust for best vision by turning viewfinder window. If dot at top of viewfinder appears blue, condition is suitable for electric eye photography. If dot appears red, there is inadequate or excessive light.
7. Compose subject and photograph.



IN FOCUS

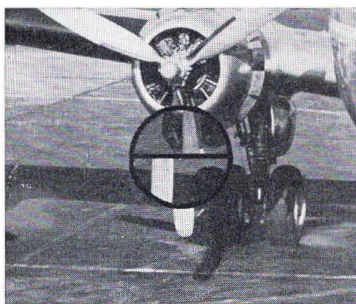

OUT OF FOCUS



BLUE DOT SIGNAL

PREPARATION FOR ELECTRIC EYE PHOTOGRAPHY

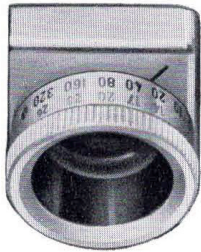

FILM INDEX DIAL

1. Set dial according to ASA or DIN index of film used.
 2. Single rule applies both to color or black & white films.
 3. Seven index figures each are given for ASA (American) and DIN (European) standard films.
- | | | | | | | | | |
|-----|--|---|----|----|----|----|-----|-----|
| ASA | | 5 | 10 | 20 | 40 | 80 | 160 | 320 |
| DIN | | 8 | 11 | 14 | 17 | 20 | 23 | 26 |
4. Intermediate settings are permissible when films for which no index figures are given are used.
 5. The seven settings have click stops.

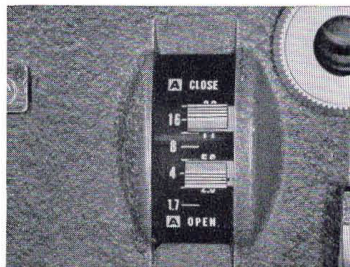
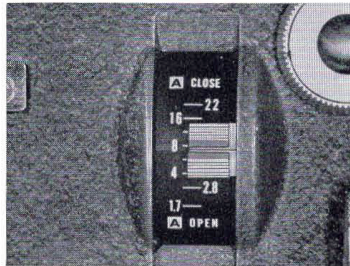
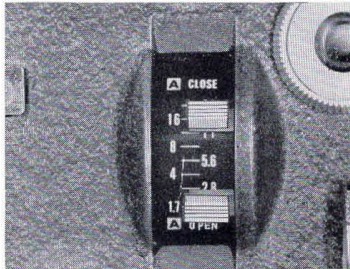

APERTURE CONTROL LEVERS

1. Fully Automatic EE Operation

- a. Keep both levers farthest apart at respective A positions.
- b. Assures EE operation for entire aperture range from F1.7 to F22.

2. Limited Automatic EE Operation

- a. This is achieved by closing gap between two levers.
- b. This limits EE operation only to aperture scales remaining between two levers.

3. Manual Operation of Aperture

- a. Bring the two levers completely together.
- b. Move both in unison to any figure opposite the line formed by a junction of two levers which will be the aperture or "f" setting.

4. Words of Caution

- a. The lens diaphragm system is the heart of your camera.
- b. Avoid unnecessary or rapid movement of either lever.

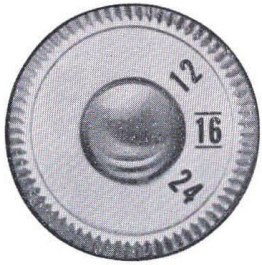

FRAME SPEED DIAL

1. **Film Speed** is represented by frame exposures per second.

- This camera provides three motion speeds plus single frame.
- The actual exposure time of each frame speed setting is as follows:

Filming Speed (frames per sec.)	12	16	24	1
Exposure Time (per sec.)	1/26	1/35	1/50	1/25

2. **16 frames per second** should be used for normal action photography.

3. **12 frames per second**

- Subject will seem to move faster than normal.
- Used to exaggerate speed of moving subjects, such as vehicles, clouds.
- Used for humorous effects in motion of human beings and animals.
- Used to compensate for inadequacy of light and avoid underexposure.

4. **24 frames per second**

- Reduces rate of motion by subject by 150%.
- For slow motion effects of moving subjects.
- Reduces blurry pictures filmed from moving and unstable vehicles.
- Reduces blurs when panning or filming moving and unstable subjects.

5. **Single frame**

- Used mainly for animated subjects and titles.
- Not to be used for single frame pictures as with still cameras.

6. **Words of warning**

- There are no compensations for intermediate settings.
- Use only the three frame speeds provided.
- Use of intermediate settings can disrupt the EE mechanism.

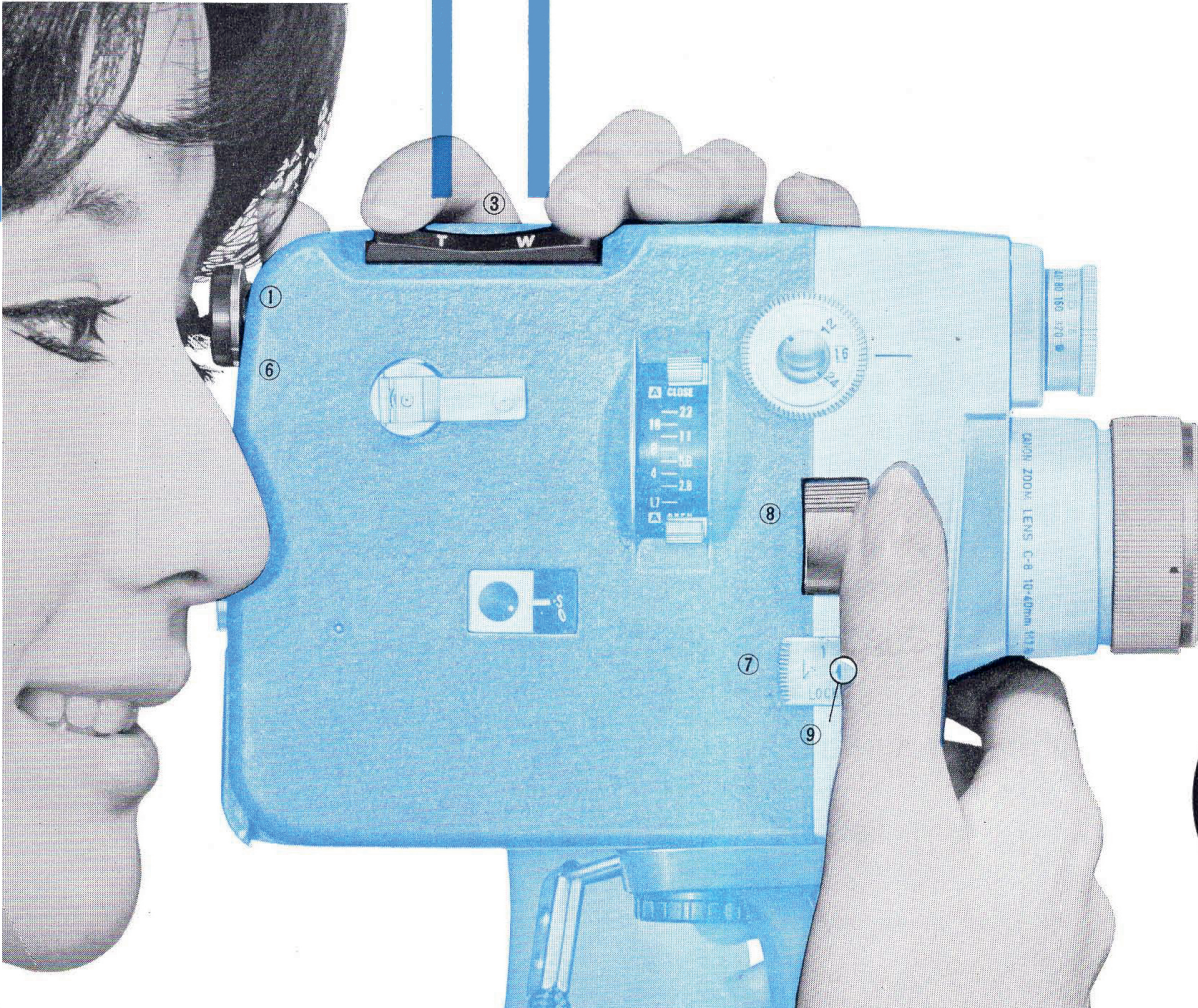
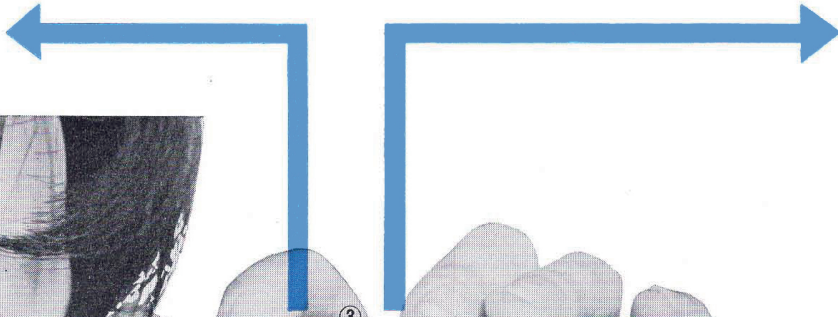

④

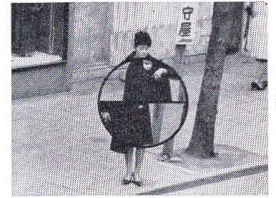

②

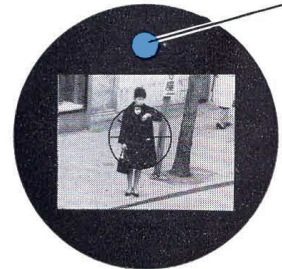

⑤

Blue

ACTUAL ELECTRIC EYE PHOTOGRAPHY

1. Turn viewfinder **eyepiece** to adjust to photographer's vision.
2. Adjustment is made when split-image line in viewfinder appears clear.
3. Press **motorized zoom** lever at T for telephoto and W for wide angle pictures.
 - a. Zoom range is from 10mm to 40mm.
 - b. Photography is possible while zooming.
 - c. Simultaneous zooming and filming will not damage the zoom or film advance motors.
4. Turn **focusing ring** to align split image on the rangefinder.
 - a. Image of subject must be aligned vertically.
 - b. Feet and metric scales on the ring give approximate distance of image in focus.
5. **Circle** inside of the viewfinder must appear blue for EE photography.
 - a. EE photography is impossible if circle shows red color.
 - b. Red is warning of inadequate or excessive light for film in use.
 - c. If light is obviously inadequate, reduce frame speed, but refrain from taking if red dot will not change to blue.
 - d. If light is excessive, Neutral Density Filters must be used to reduce the amount of light entering through the lens. (see page 32)
6. The **viewfinder** is a single lens reflex type, in which you see your subject through the taking lens.
 - a. This means there are no parallax problems and you take what you see.
 - b. This lens-viewfinder system is composed of 24 optically correct lens elements, plus 3 mirrors.
 - c. Since the half-mirror which deflects the image to your viewfinder is located in front of the shutter system and lens iris there are no flickers, and maximum light is obtained no matter how small your aperture setting.
7. The **shutter safety lock** lever is open when in a horizontal position.
 - a. The shutter is locked in the down position.
 - b. **Continuous run** is possible if the shutter release button is first depressed and then the safety lock lever is turned down.
 - c. The film will continue to advance automatically until the lock lever is brought back to a horizontal position.
8. Single frame photography is possible by pushing the shutter release button up.
9. Single frame pictures can also be taken by screwing a cable release into the safety lock socket.
10. A cine self timer can also be inserted if the photographer wishes to photograph himself.
11. **Length of a scene**
 - a. This is a relative matter and usually depends on the photographer plus the subject being photographed.
 - b. Basically no scene should be shorter than five seconds.
 - c. This need not be longer than 20 seconds at the most.
 - d. The longer the exposures scene the fewer the scenes per 50 feet of roll.

HOLDING THE CAMERA AND ATTACHING THE HANDGRIP

1. The right hand

- a. Place the thumb over the shutter release button.
- b. The index and middle fingers should circle the camera right under the lens.
- c. The ring and little fingers should go around the handgrip.

2. The left hand

- a. The palm of the hand should rest against the left side of the camera.
- b. Place the thumb on the left side of the eyepiece.
- c. Place all other fingers on top of the camera.
- d. Place the index and middle fingers specifically over the zooming lever as illustrated.

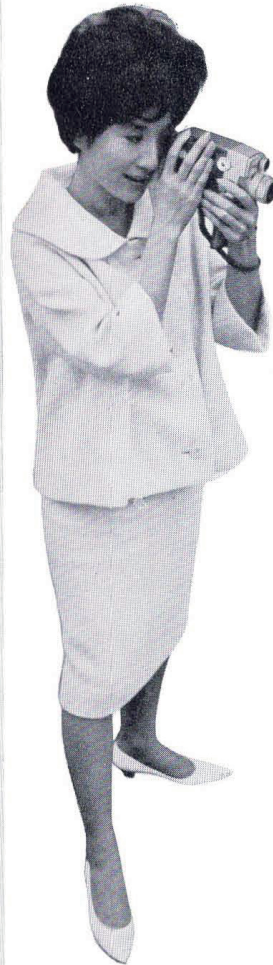
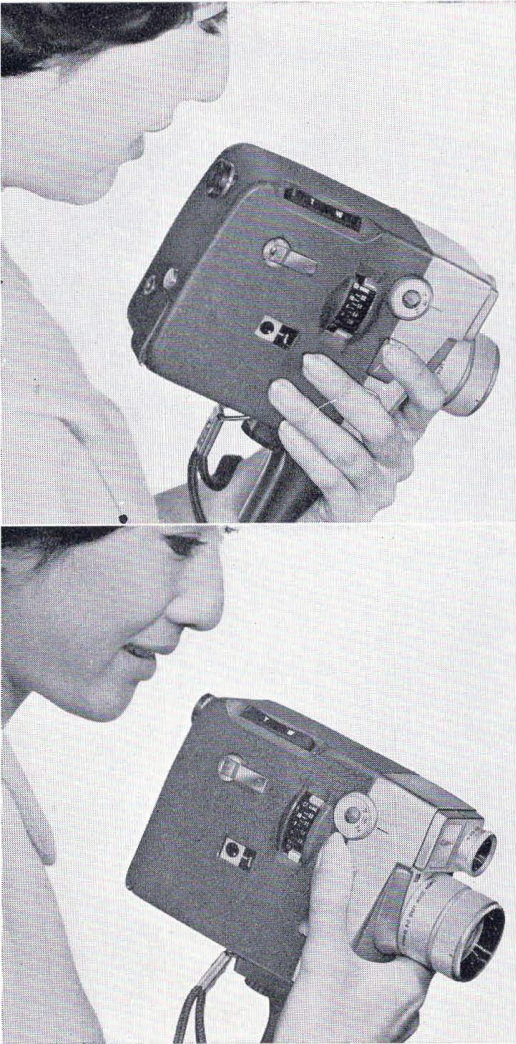

3. Hold the camera firmly

- a. Use a tripod whenever possible, remembering this is how the serious amateur and professional photographers take motion pictures.
- b. Avoid panning and try to film long subjects in separate scenes or sections as much as possible.



4. No limit to choice of grip

- a. Each person is free to devise his or her ideal grip for picture taking.
- b. We have illustrated what we consider the best grip to eliminate cross motions of hands when operating the lens focus, zoom and film advance.

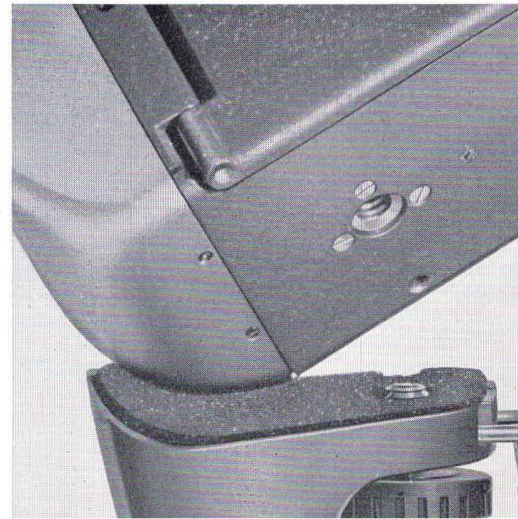

LENS APERTURE CONTROL LEVERS—are provided to give the photographer a choice of

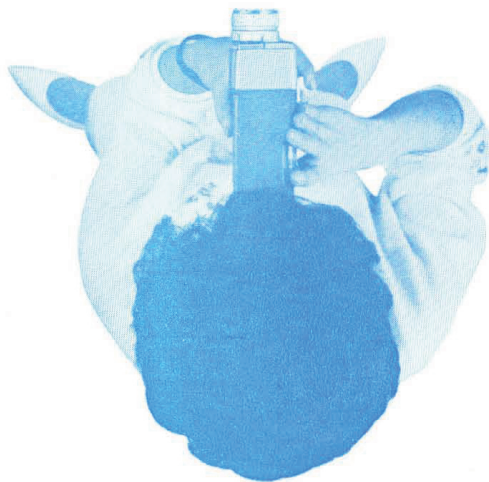

total or limited range of Electric Eye operation, plus the features of fade-in, fade-out and overlap.

A. Automatic Operation (Fig. 1)

(Fig. 1)



1. Spread the two levers at opposite extremes at the Close A and Open A positions.
2. EE operation will take place over entire aperture scale from F1.7 to F22.
3. For normal photography this is the manner in which the camera should be used.

B. Manual Operation (Fig. 2)

(Fig. 2)

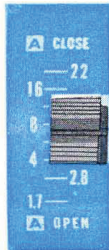

1. When the two levers are brought together EE operation ceases.
2. The two levers must be moved together to the aperture setting desired.
3. The number opposite the center line formed by the two levers is your F opening or aperture setting, for instance, F8 in Fig. 2.

C. Limited Automatic Operation (Fig. 3, 4, 5)

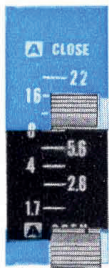

(Fig. 3)

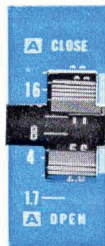

(Fig. 4)

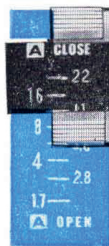

(Fig.5)

1. The field of automatic or EE operation can be narrowed by moving one or both of the aperture control levers closer together.
2. Fig. 3 shows EE operational area to be between F8 and F11.
3. Fig. 4 shows EE operational area to be between F11 and F5.6.
4. Fig. 5 shows EE operational area to be between F11 and F22.
5. This system of intentional EE restriction is useful when exposure is desired for a backlighted subject.

Fig. 1 FADE-OUT

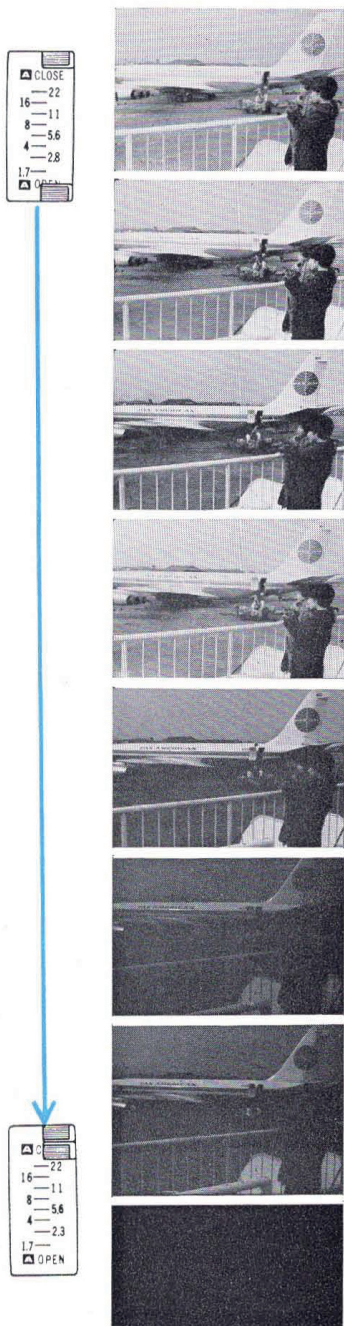

Fig. 2 FADE-IN

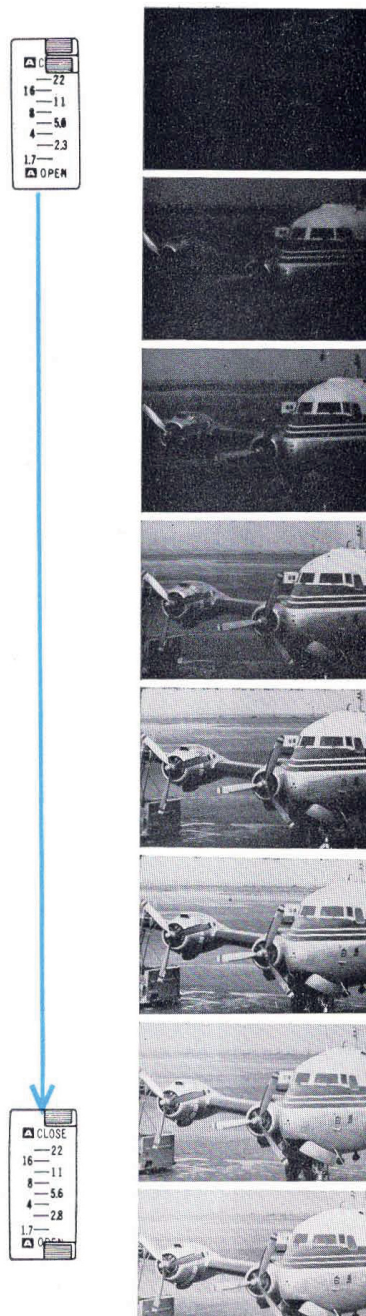
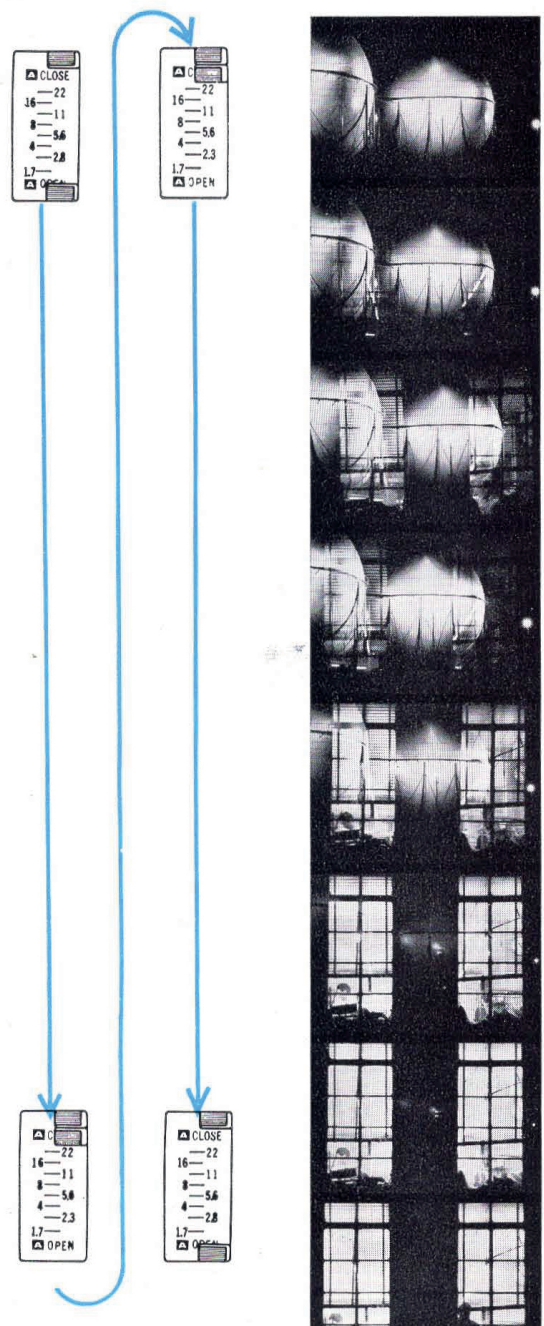

Fig. 3 OVERLAP



FADE-OUT AND FADE-IN OPERATIONS

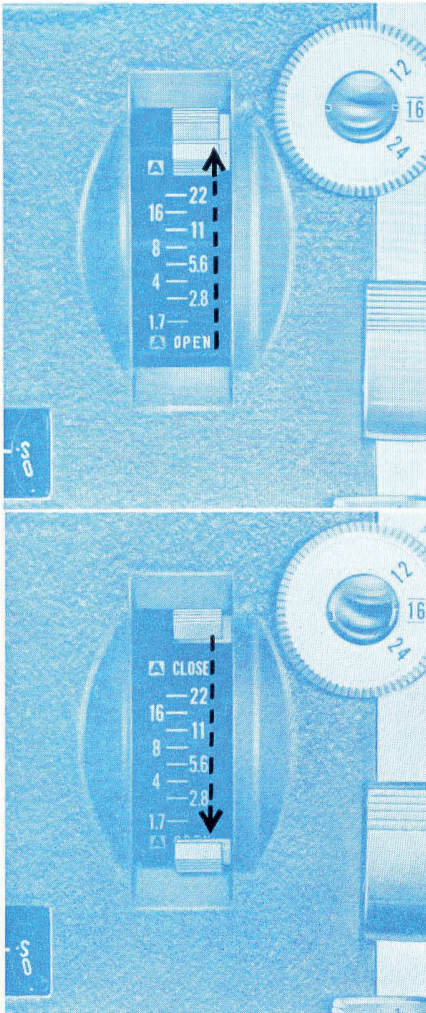

Fig. 1 FADE-OUT

Gradually lift lower aperture control lever while filming.

This action progressively closes the aperture.

The picture gradually fades as there is progressive underexposure until there is no exposure at all.

The picture will completely fade-out as the lever reaches the top of the scale and the aperture is totally closed.

Fig. 2 FADE-IN

Gradually bring only the lower lever down. As the lower lever reaches the bottom of the scale the EE mechanism takes over for perfect exposure.

Fig. 3 OVERLAP

In normal Fade-In and Fade-Out, a given scene is made to fade-in at the end of a fade-out of the previous scene.

In Overlap the fade-in of a scene is superimposed on the fade-out portion of the previous scene.

First, fade-out scene as in fig. 1, remembering position of film footage counter.

Secondly, put on the lens cover and rewind the same length of film used in fade-out, by paying attention to the footage counter.

Thirdly, now effect fade-in of new scene as illustrated in fig. 2.

FILM REWIND OPERATION

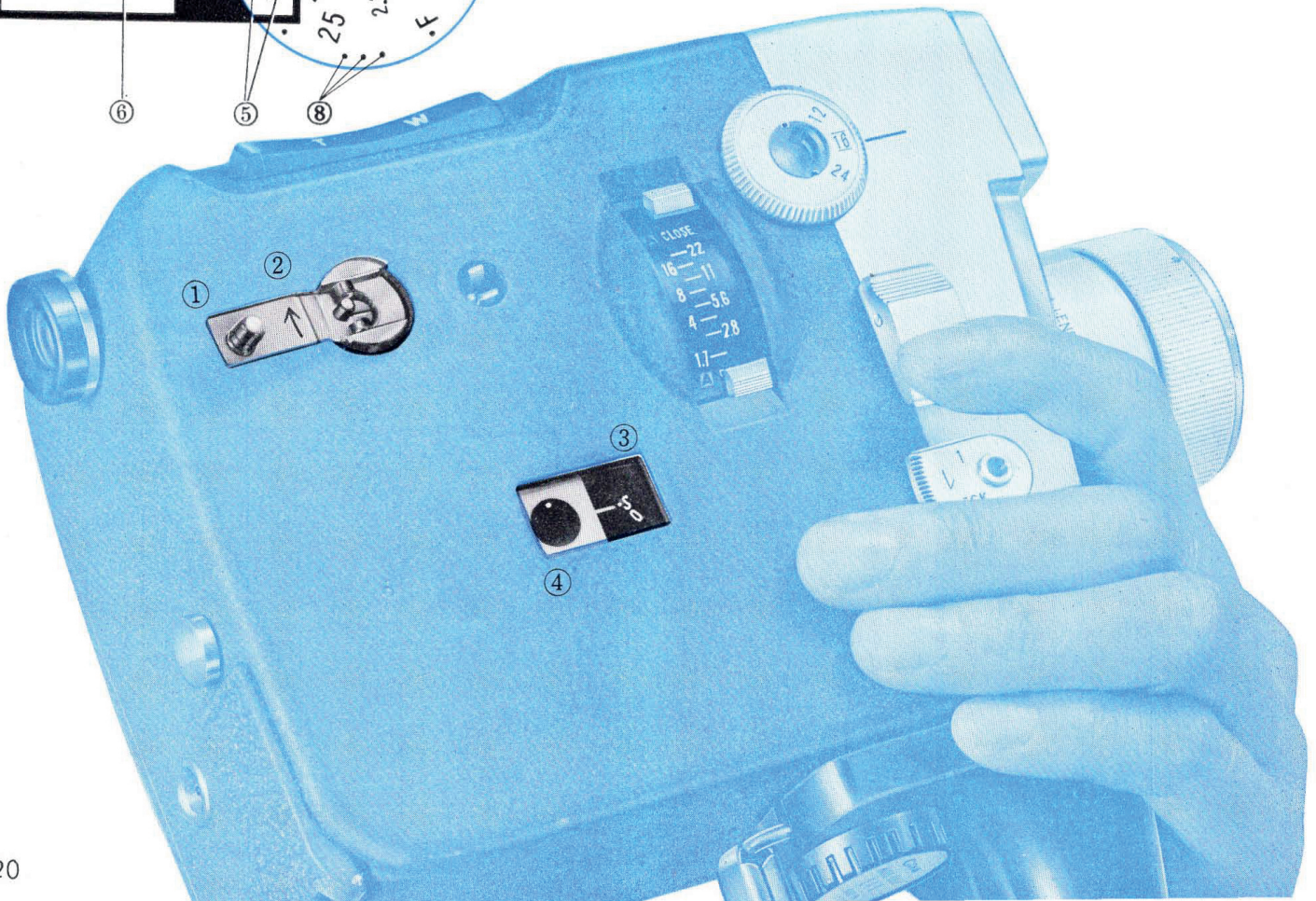
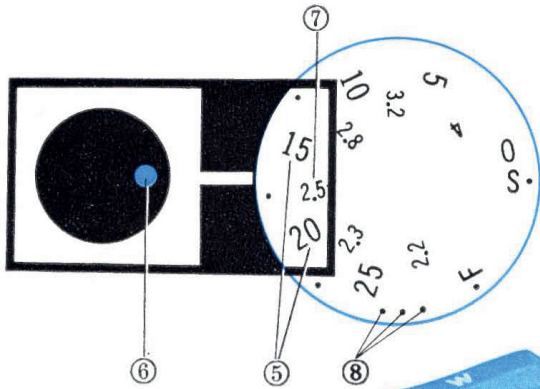

FILM REWIND OPERATION

1. Raise rewind crank for winding, and be sure the lens cap is on.
2. Wind in direction of arrow only.
3. Watch footage counter for length to be rewound.
4. Watch carefully the rotation of this dial.
5. Figure in white, indicating footage used, will remain stationary during rewind.
6. Revolution of dot equals revolution of film feed spindle.
7. Orange figure indicates number of times white dot must be rotated to return one foot of film for overlap or double exposure. In this example (insert) it is two and a half times (2.5). If two feet of overlap is desired, double the rotation.
8. At the end of a 25-foot run, expose film to the first of the three dots which follows the figure 25, if one foot of film had been rewound for overlap effect. Be careful not to expose beyond this point as it is a light leak area when unloading.

FILM LOADING, RELOADING AND UNLOADING

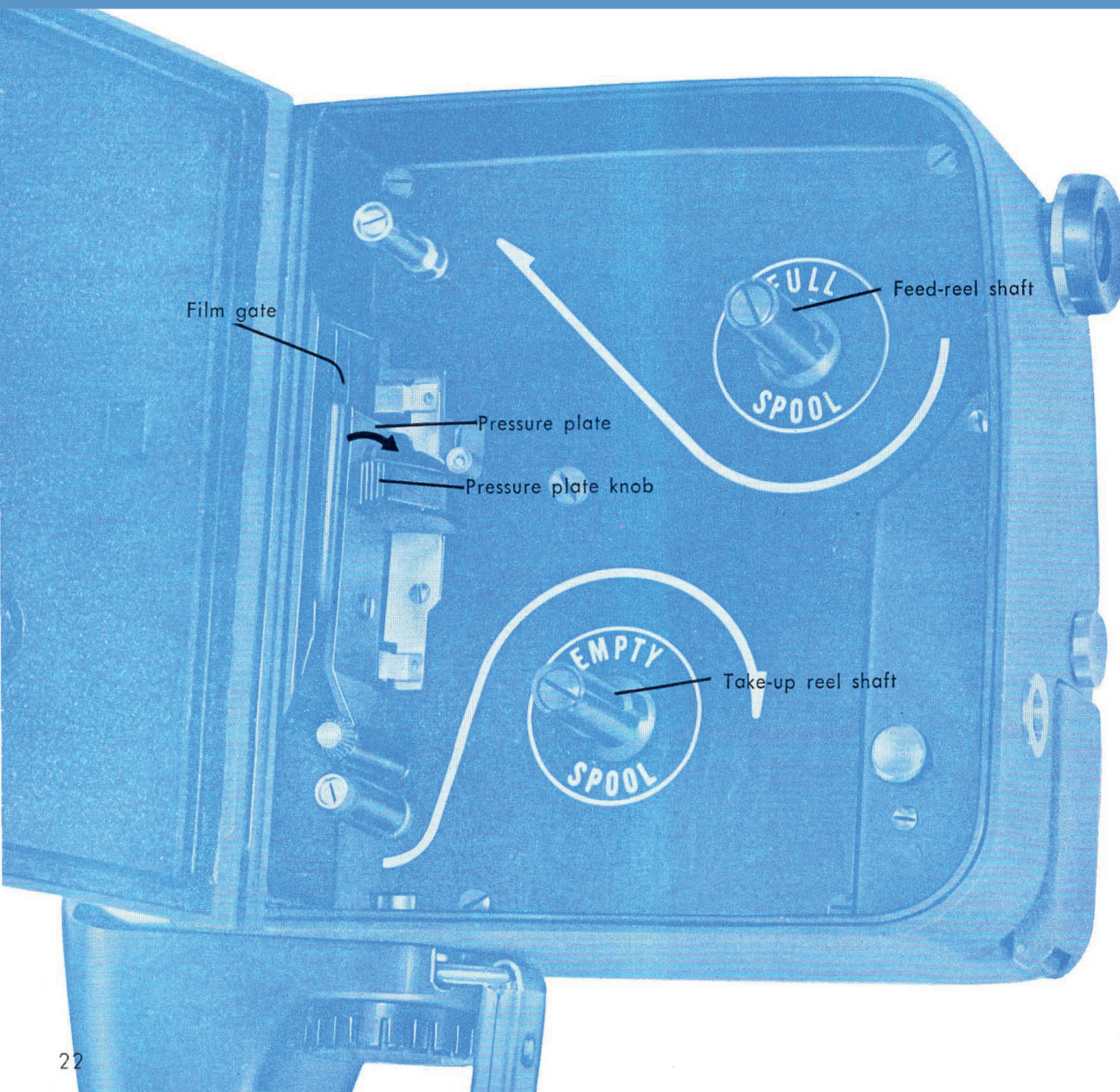

Film gate

Pressure plate

Pressure plate knob

Feed-reel shaft

Take-up reel shaft

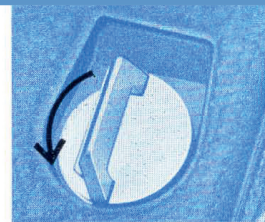
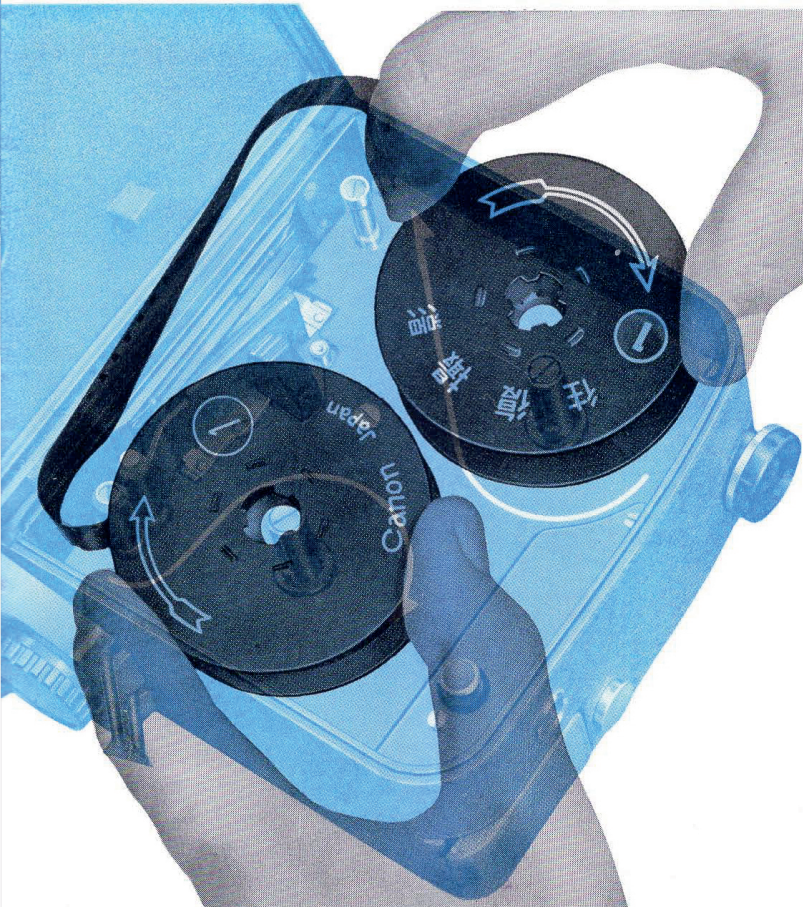

Fig. 1

Fig. 2

FILM LOADING PROCEDURE

1. Fig. 1 Open camera cover by turning lock counter-clockwise.
2. Fig. 2 Open film gate by pulling back pressure plate knob.



3. Fig. 2 Bend film about half an inch from the end and insert into slit of Canon take-up reel.
4. Fig. 2 Initially, wind film approximately ten times around take-up reel clockwise. Drop load both reels onto respective shafts.
5. Fig. 2 Place film through film gate, emulsion side out, and push pressure plate shut. Then test smooth advance by running film for a few frames.
6. Close cover, advance film from letter S to 0 on the footage counter.

RELOADING PROCEDURE

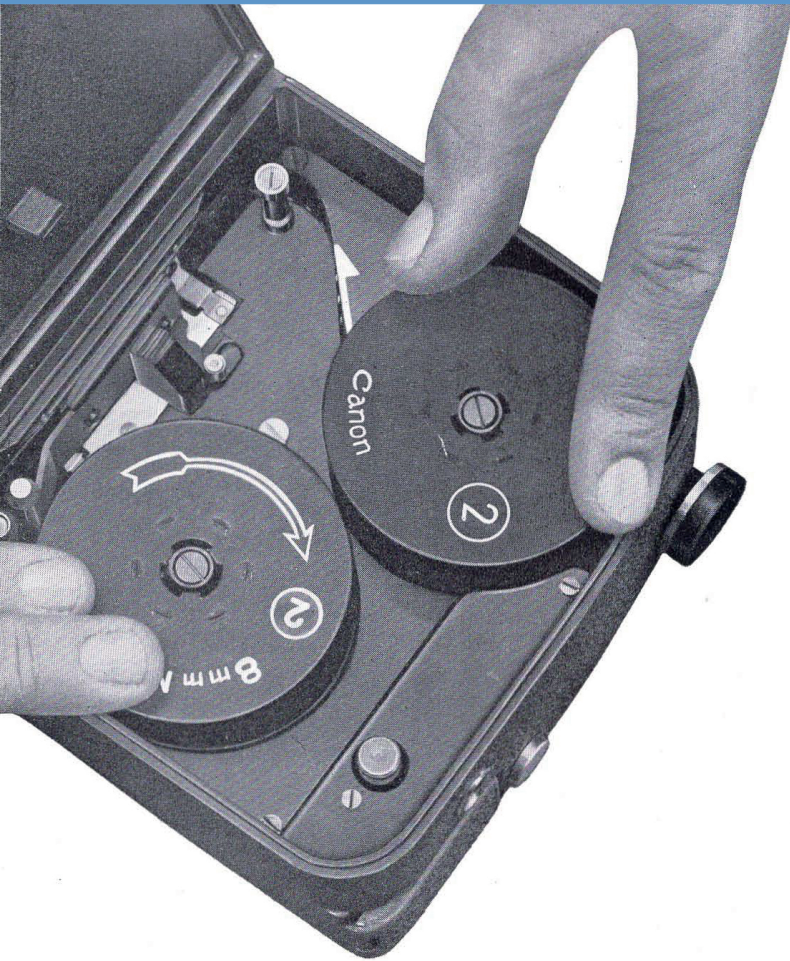

Fig. 3

RELOADING PROCEDURE

1. Fig. 3 After first side is exposed continue to advance film until footage counter reaches "F".
2. Fig. 3 Remove both reels and use same procedure as that for loading.
3. Fig. 3 Canon reel with film goes on shaft at the top of the camera, with side numbered "2" facing up.
4. Fig. 3 Original film reel is placed at the bottom of the camera also with side "2" facing up.

UNLOADING

1. Advance film at the end of reel at least until footage counter reaches "F".
2. Open camera in shade and never in direct sunlight.
3. Place exposed film in original can and mail to processing laboratory as soon as possible for best color rendition.

REPLACEMENT OF MERCURY BATTERIES



REPLACEMENT OF MERCURY CELL FOR EXPOSURE METER SYSTEM

1. Slide Canon name plate to left.
2. Unscrew chamber cap.
3. Insert cell with plus (+) side facing out and minus (-) side facing meter contact.

Avoid Fingerprints and Sweat

When loading a mercury battery, clean the both poles of the battery with dry cloth. Remove the battery from the camera if the camera is not to be used for any length of time, and choose dry place for storing.

When replacing the battery, the following mercury batteries are available on the market:

RM-640R	by Mallory (U.S.A.)
M-N	by National (Japan)
E 640	by Eveready (U.S.A.)

REPLACEMENT OF PENLIGHT BATTERIES FOR ZOOM AND FILM DRIVE MOTORS

REPLACEMENT OF PENLIGHT BATTERIES FOR ZOOM AND FILM DRIVE MOTORS

1. Push battery chamber cover lock up.
2. Open chamber cover completely.
3. Remove penlight battery magazine.
4. Slide out the back cover.

It is possible to expose approximately 15 to 20 rolls of film with one set of batteries. When the camera is not to be used for several days, remove battery magazine.

If camera is not to be used for an extended period, then also remove battery from magazine, and store in dry place. Humidity and dampness reduce life of batteries. For electric source, use four 1.5V penlight batteries.

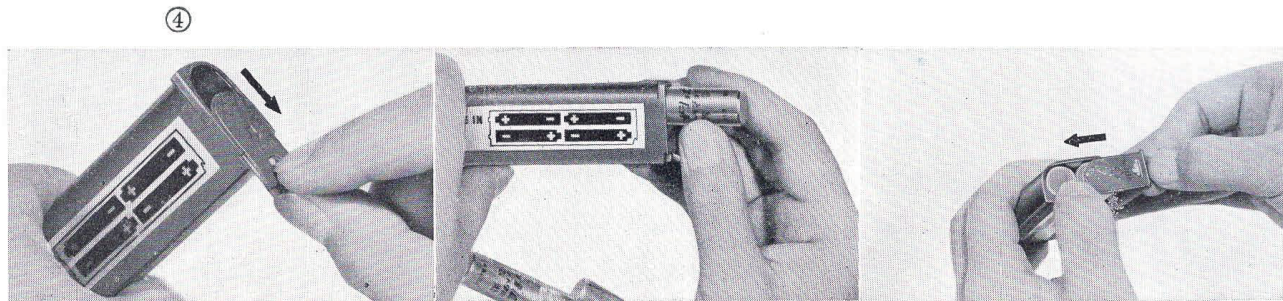
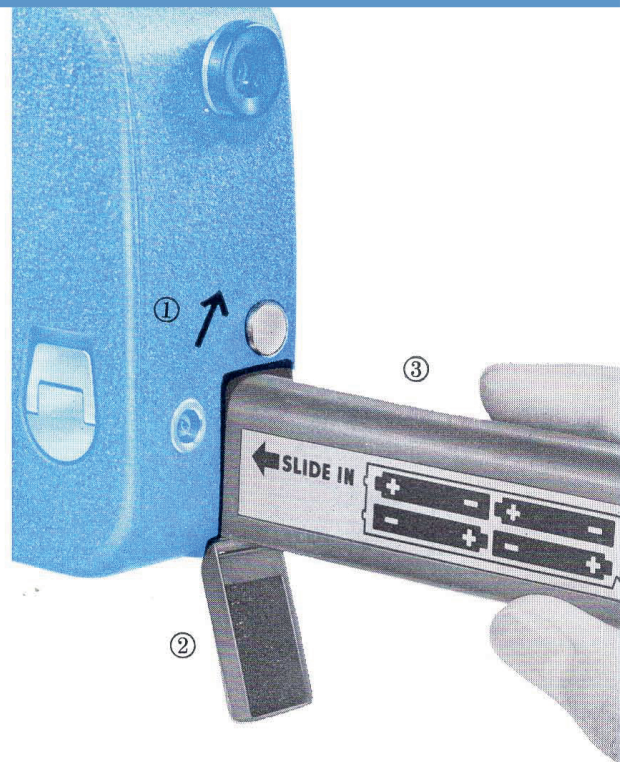

ACCESSORIES AND THEIR USES

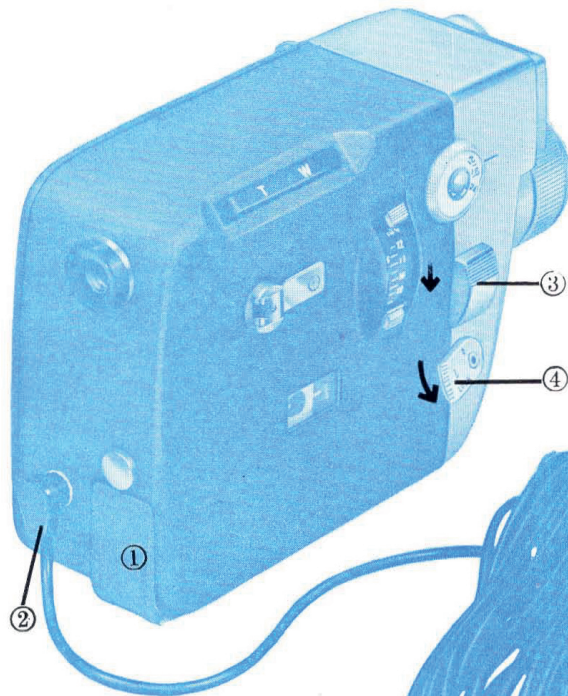

REMOTE CONTROL DEVICE - for continuous filming

1. Remove battery magazine from camera and insert into Remote Control Device.
2. Plug Remote Control Cable into camera.
3. Press down Shutter Release Button.
4. Turn down Safety Lock to keep Shutter Release Button in continuous run position.
5. Press Remote Control Switch to operate camera.

Note: Single frame exposure and auto-zooming are not possible with the Remote Control Device.

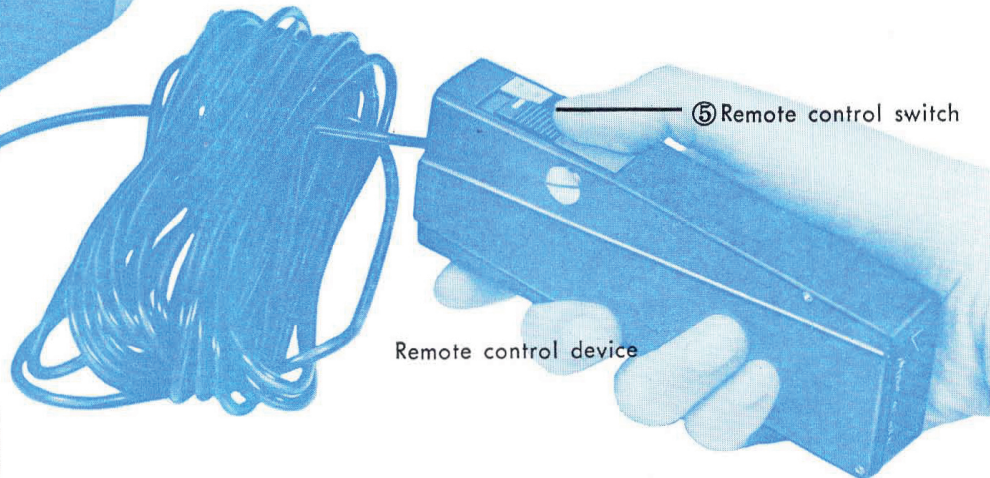

BATTERY CHECKER

1. Remove cover and plug tip into remote control socket.
Swing needle will indicate voltage of battery from good to bad.

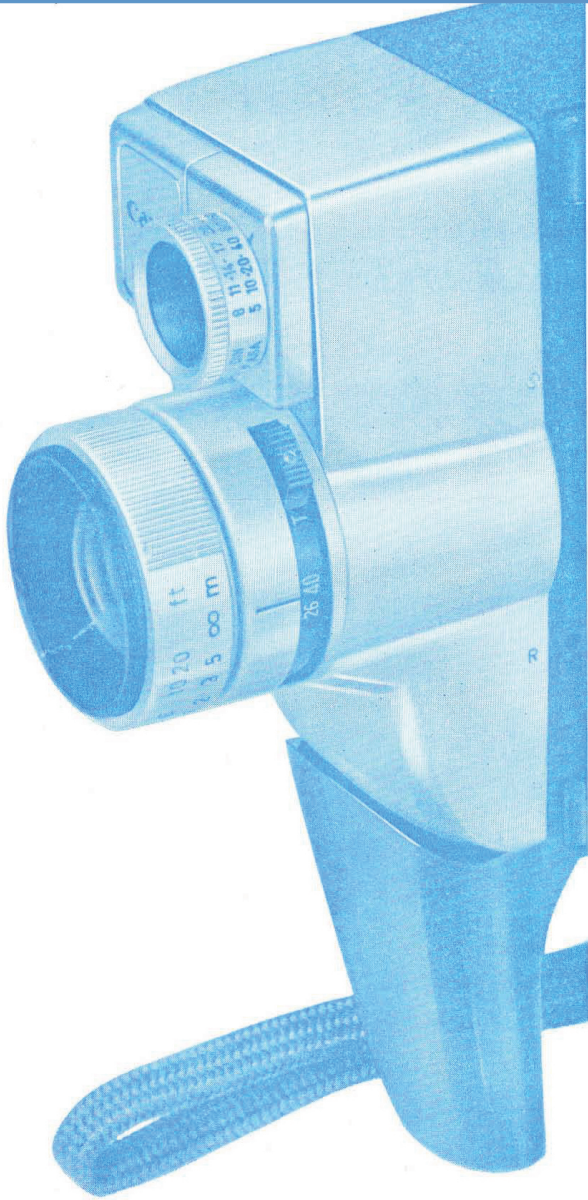

CANON C-8 CONVERTER MODEL 2

Canon C-8 Converter Model 2 is an attachment to be attached to the shooting lens of Canon Motor Zoom 8 EEE to convert it into a short focal length zoom lens. The magnification conversion range or focal length in this case is from 6.5mm to 26mm. This means that with the standard 13mm as the central focal length, photography in a wide range is possible.

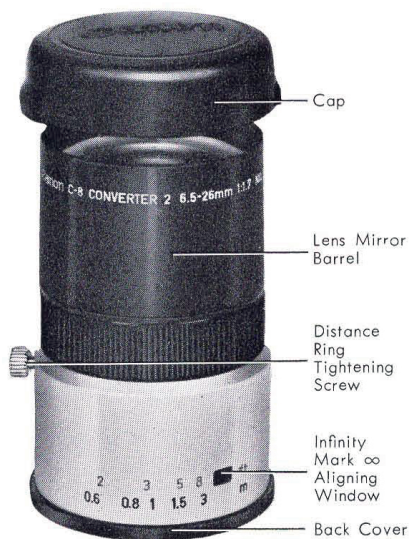

Photographic Range

	Lens Speed	Zooming Ratio	Magnification Conversion	Zooming Range (Focal Length)
Before attachment	F 1.7	4	Continuous	10mm - 40mm
After attachment	F 1.7	4	Continuous	6.5mm - 26mm

Lens Composition:

This Converter is of the afocal system, composed of 5 elements in 2 components, and is optically designed for exclusive Canon Motor Zoom 8 EEE use.

Coating: Purple

Distance Scale: ft. ∞ 8 5 3 2
m ∞ 3 1.5 1 0.8 0.6

Size: Overall length 66.5 mm
Max. diameter 45 mm

Weight: 110 g

HOW TO USE

Remove the back cover of Canon C-8 Converter Model 2.

1. Remove the attachment ring from the front panel on the camera lens.
2. Attach the distance ring of the Converter onto the camera lens and screw the Converter into the front panel of the lens.
3. Loosen the Converter tightening screw.
4. Turn the distance ring of the Converter so that the infinity mark of the lens appears in the infinity mark window.
5. Tighten the Converter tightening screw.
6. The Converter can be attached to the camera lens without removing the filter. Therefore, filters for the Converter are unnecessary.
7. The Converter can even be attached to the camera lens over a Neutral Density filter and one more filter.

* A hood exclusively for the Converter is available.

MOUNTING OF FILTERS

The diameter of the attachment thread of the camera is 1-11/32" (3.4 cm), whereas the diameter for that of Canon C-8 Converter EEE is 1-9/16" (4 cm). This is because the aperture of the converter must be large enough to take in sufficient light rays for wide-angle.

The optical system of the converter has been designed so that the converter can be used with the filter still mounted on the camera. This eliminates the necessity of carrying two different sizes of filters. There is no special problem with ordinary filters since they are relatively thin. The converter can also be attached to the camera even when using the Neutral Density (ND) Filter over which another filter can be placed. In this respect, ND4 & ND8 filters are designed differently from other screw-in type filters.

FILTERS

34mm Screw-in Type with Plastic Case



For Color : Skylight filter (IX)

Color conversion filter A (2X) . . . tungsten type film in direct daylight.

Color conversion filter B (3X) . . . daylight type film in artificial light.

For Black and White :	UV	Ultra Violet (IX)	O1	Orange (3X)
	Y 1	Light Yellow (1.5X)	G1	Light Green (3X)
	Y 3	Yellow (2X)	R1	Red (6X)

Note: Figures inside brackets () denote Filter Factor.

NEUTRAL DENSITY (ND) FILTERS

These filters can be used with color or black and white films. They serve to reduce the intensity of light when films of high ASA or DIN indexes are used. Canon manufactures two Neutral Density Filters, the ND 4 and ND 8, which reduce the amount of light penetrating to the film by four and eight times respectively.

When such filters are used the index of a given film is altered as follows :

1. ASA 640 film + ND 4 = ASA 160 film.
2. ASA 640 film + ND 8 = ASA 80 film.

Neutral Density Filters can also be used together with other types of filters for both black and white and color films.



CANON 34 mm CLOSE-UP LENS 450

This is used for film titling as well as close-up work. Close-up Lens is of screw-in type. See the chart below for specifications . . .

Focal Length of Zoom Lens	Distance Scale of Focusing Ring		Distance from Film plane to Object		Field-of-View	
	(feet)	(meter)	(feet)	(mm.)	(inch)	(mm)
10 mm	∞	∞	1'9 ⁵ / ₁₆	541	5 ³ / ₁₆ × 7 ¹³ / ₁₆	148 × 197
	4	1.2	1'4 ⁵ / ₁₆	413	4" × 5 ³ / ₈	102 × 136
40 mm	∞	∞	1'9 ⁵ / ₁₆	541	1 ¹ / ₂ × 1 ⁷ / ₈	37 × 49
	4	1.2	1'4 ⁵ / ₁₆	413	1" × 1 ⁵ / ₁₆	26 × 34

WORDS OF CAUTION AND MAINTENANCE RULES

BATTERY CHECK

If camera is not to be used for any length of time, remove penlight battery magazine and keep it in a cool, dry place. Make certain battery is loaded in proper position and has sufficient voltage.

STRAY LIGHT

Sometimes light filtering through the viewfinder can cast slight ghost images on the film when the camera is used under remote control. This may even happen when the eye is fairly removed from the viewfinder in panning and tilting shots. When shooting under such conditions, see that the viewfinder is not in the path of intense light.

CLEANING FILM GATE

Lint and dust in the film gate will produce spots on the film. Brushing at regular intervals is recommended to prevent this. Stubborn articles should be removed with a toothpick or match stick. But never use metal objects.

STORAGE AND MAINTENANCE

When not in use, keep camera in a place free from moisture, heat, dust and chemicals such as camphor and naphthaline. It is not necessary to oil movable parts. Periodic professional checking and cleaning of camera is recommended. The minimum cost for such service can prevent a great deal of disappointments and inconveniences.

GUIDE TO GOOD PHOTOGRAPHY

These instructions are given to acquaint you with the mechanics of the Canon Motor Zoom 8 EEE. Techniques of photography such as panning, special effects, tilting, etc. can be learned from special publications available at camera shops and libraries. Free catalogues are also provided for the asking by camera magazine publishers.

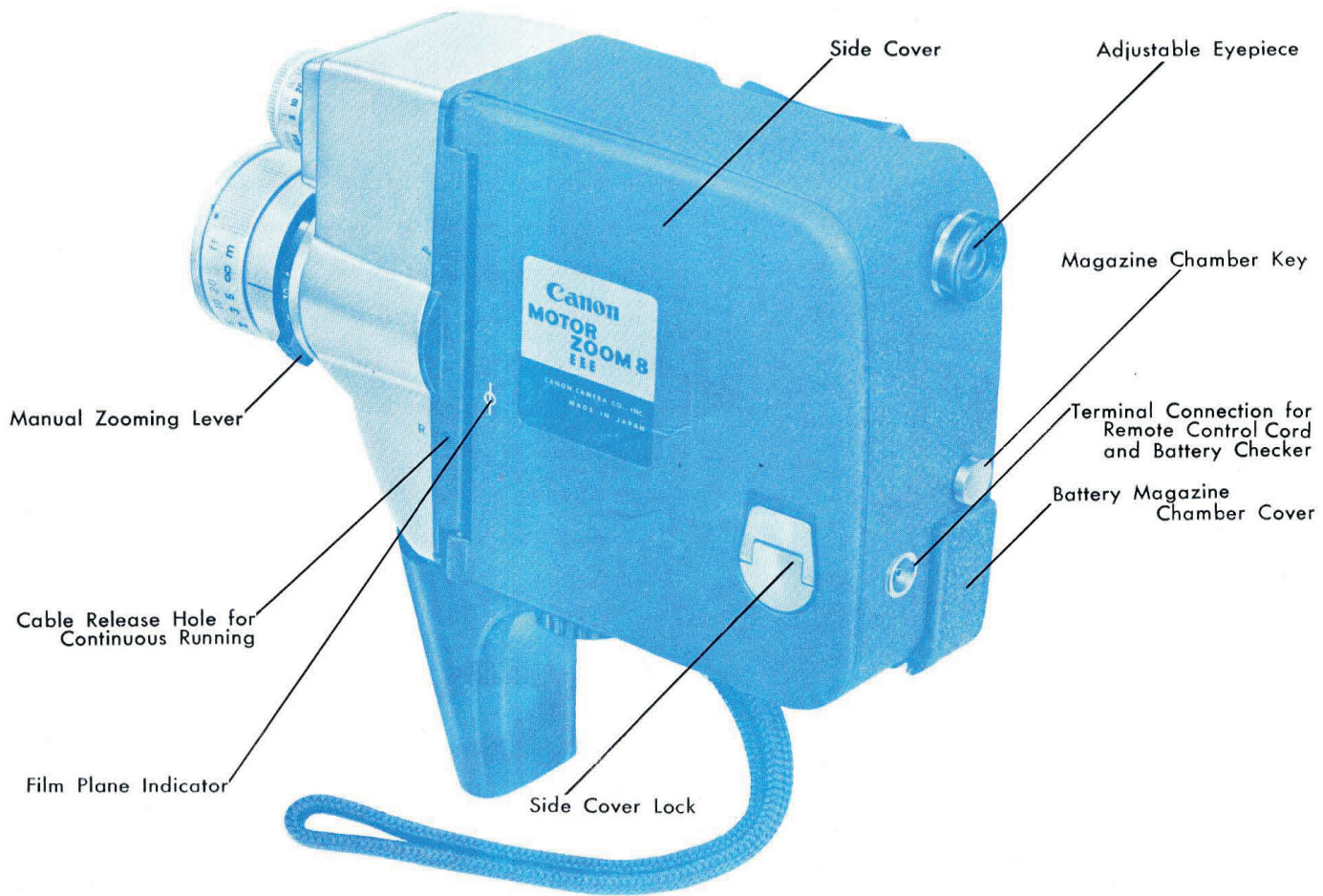

Fig. 2 View of Cover Panel Side

TITLING DEVICE

Filming a title will be very simple and convenient if the Canon Copying Stand is used with the Canon Motor Zoom 8 EEE.



CANON PROJECTOR P-8

The balanced construction of this projector provides flicker free pictures on the screen. Damage to film is prevented by a system providing fairly low temperature at the film gate. Precision manufacture of parts guarantees long trouble-free performance. The sturdy motor is designed to function evenly even under power fluctuations. It has a 19 mm F1.4 projection lens, utilizes a 500 Watt pre-focus lamp of Bell & Howell mount. It takes a 400 feet reel. Models are available for use under 100, 110, 125, 220 and 240 volts.

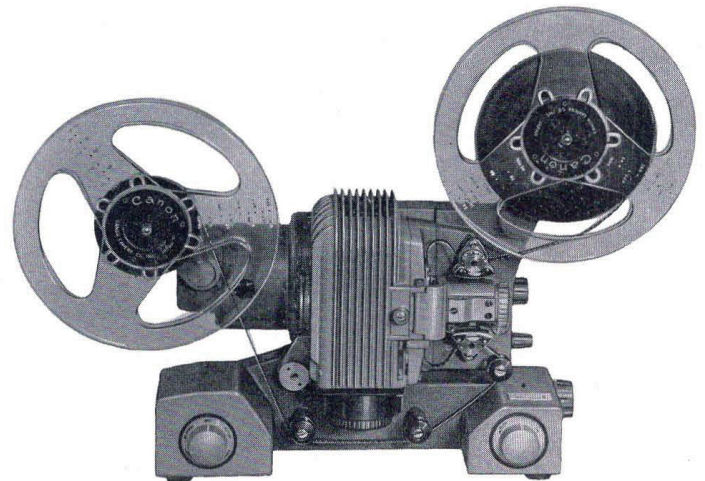

CANON CAMERA CO., INC.

312 Shimo-Maruko-cho, Ohta-ku, Tokyo, Japan

CANON U.S. BRANCH

30 East 42nd St., New York 17, U.S.A.

CANON S.A. GENEVE

1 Rue de Hesse Geneve, Switzerland

CANON LATIN AMERICA

Apartado 7022, Via España 120, Panama, Republic of Panama