

Canon SUPER 8
ZOOM 518
Canon SUPER 8
ZOOM 318

INSTRUCTIONS

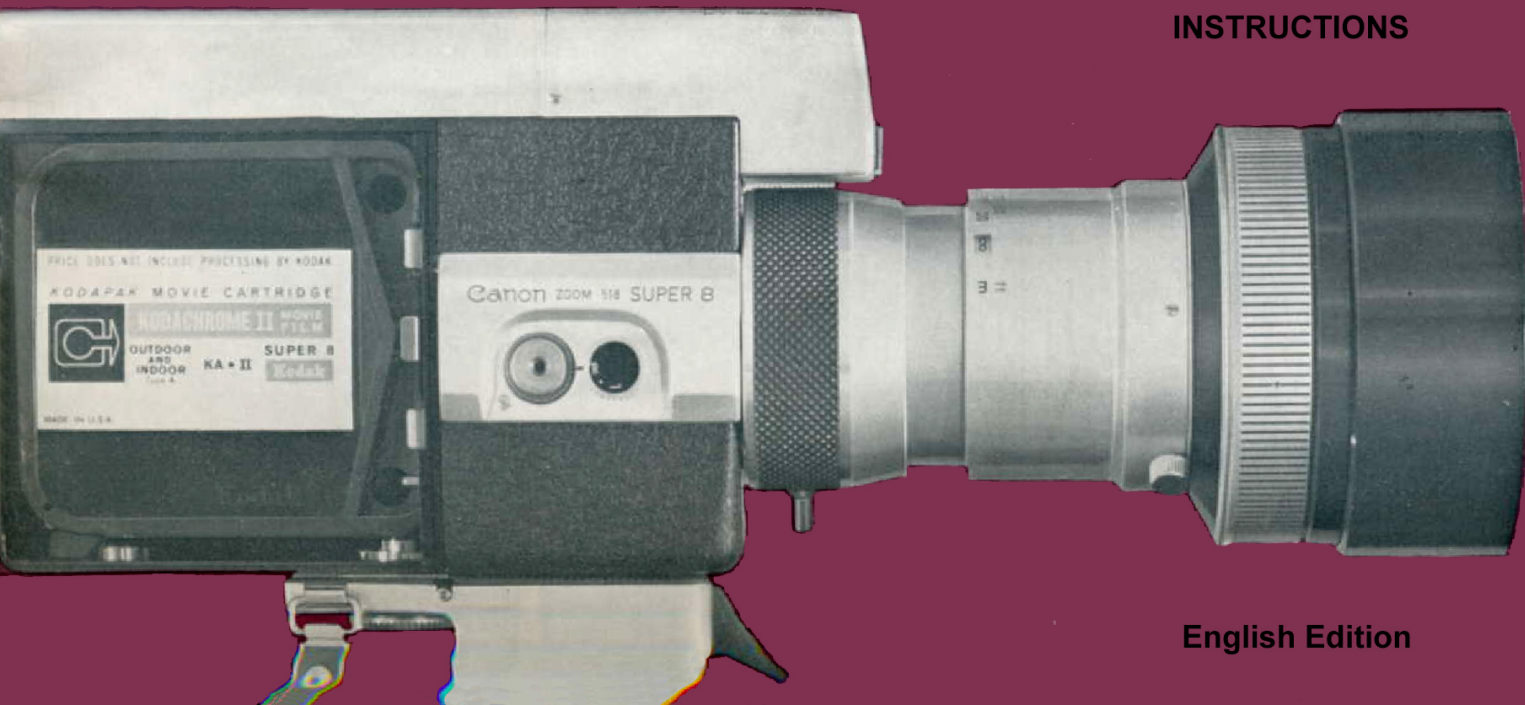

English Edition



Canon SUPER 8 **Canon** SUPER 8
ZOOM 518 ZOOM 318

Follow these simple steps...

Film Type
Window

Shutter Lock
Dial

Side Cover
Latch

Shutter Release
Button

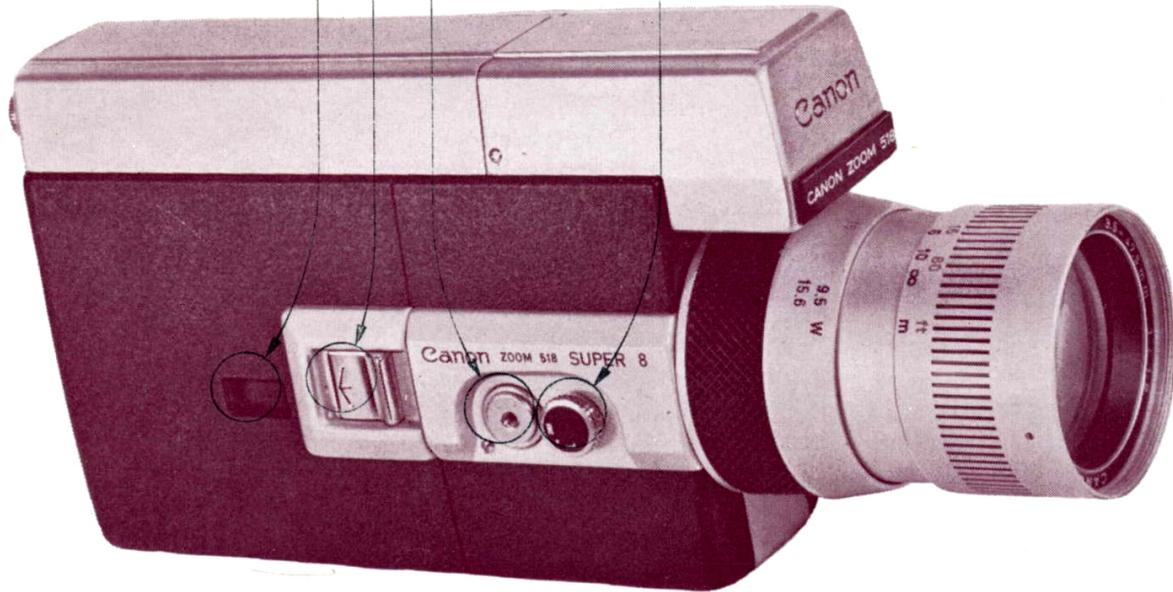

1

Insert Super 8 film cartridge.

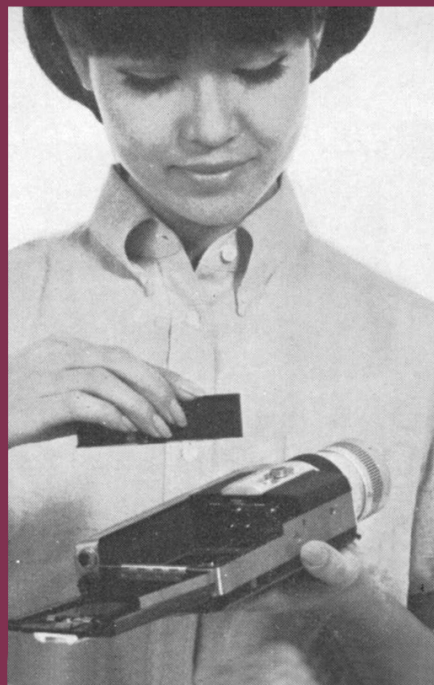
**2**

Remove the lens cap.

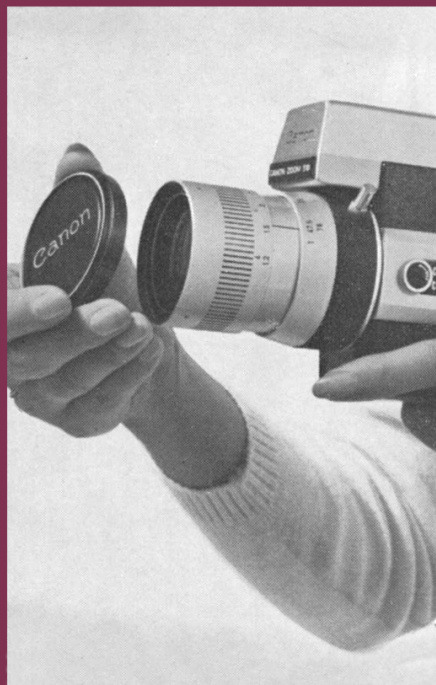
**3**

Look through the viewfinder.

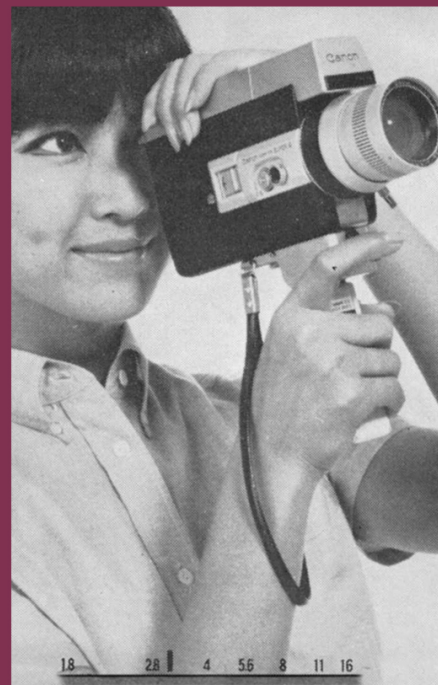

4

Focus, and check whether the exposure meter needle is within the proper range.

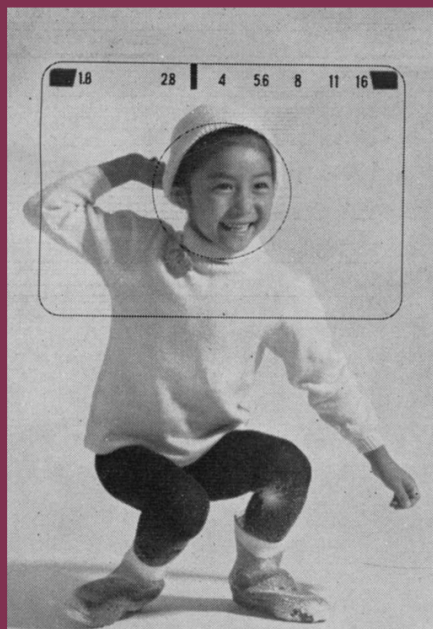

5

Rotate zooming lever and adjust size of subject.

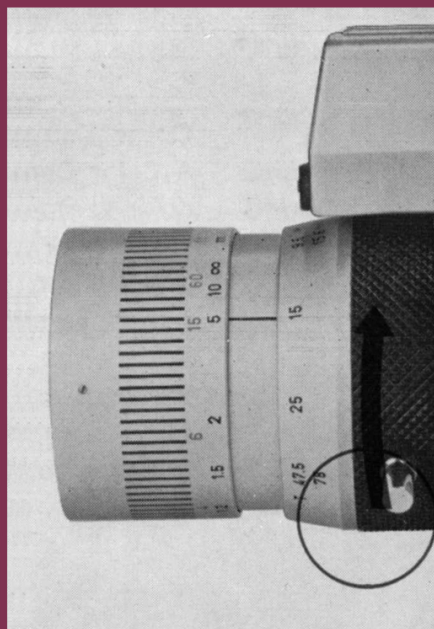

6

Press the shutter release button.

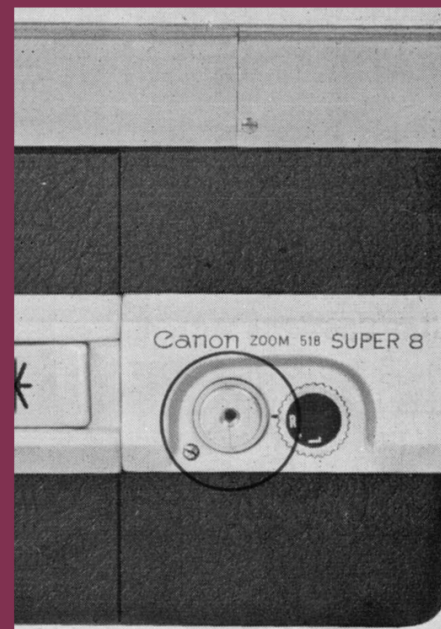

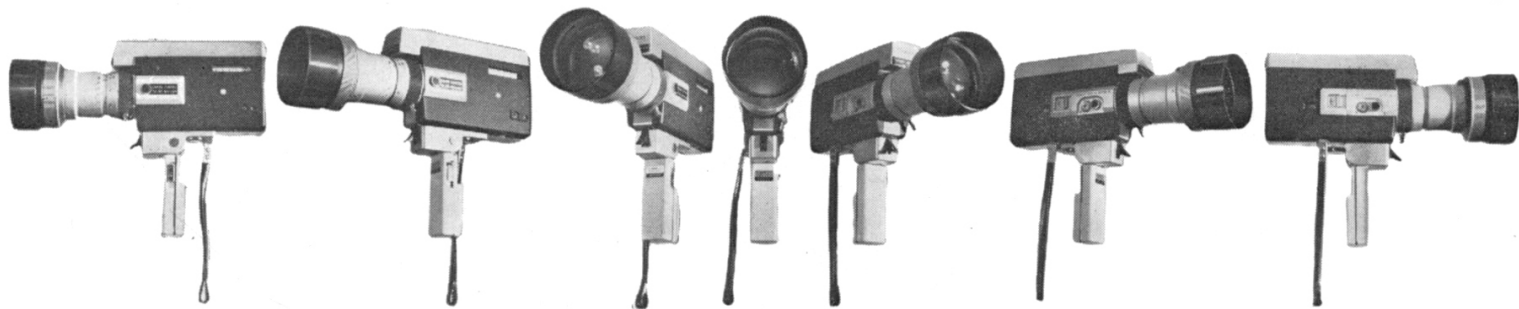

FEATURES OF SUPER 8 SYSTEM

Simple Film Loading

Canon Zoom 518 and 318 incorporate the new Super 8 system. Just slip in the entire Super 8 cartridge which holds a continuous 50-foot length of film.

Film Speed is Automatically Set

The Super 8 cartridges have differently positioned slots according to the type of film. Therefore, when the film cartridge is slipped into the camera the film speed is automatically set and properly exposed pictures can always be shot.

Color Temperature Conversion Filter

A Color Conversion A type filter for conversion of color temperature has been built into the optical system. This enables the use of tungsten type film in daylight. When shooting under artificial light, the conversion can be easily made by simply setting upright the filter conversion pin on the trigger grip. When using daylight film from the beginning, the filter is automatically removed with the insertion of the film cartridge and shooting can be performed in that condition.

SPECIFICATIONS

Canon Zoom 518

Type: 8mm cine camera, employing Super 8 film cartridge. Not necessary to turn cartridge over.

Frame Size: 4 x 5.4mm Super 8 size film.

Lens: F 1.8 with zooming range of 9.5—47.5mm. 11-component, 14-element construction. Zoom ratio, 1:5. Zooming is manual by rotation of lens barrel. Zoom range can be extended to super-telephoto (15.6—78mm) with optional tele-converter.

Viewfinder: Parallax-free single lens reflex type, including 4 prisms and 11-element lens construction. Built-in prism screen focusing system and exposure meter indicator. Eyepiece can be adjusted to the eyesight of photographer.

Exposure Meter: Through-the-lens system, with highly sensitive CdS meter. Batteries for EE systems are two 1.3V # 625.

EE System: Film sensitivity, filming speed and aperture setting are coupled. Aperture warning marks for under- or over-exposure are shown in viewfinder. Automatic adjustment for filters.

Film Speed Range: With tungsten type film, ASA 25—160. With daylight type film, ASA 16—100. Film sensitivity is set automatically.

CCA Filter: Built into camera, automatically corrects for exposure of tungsten film for daylight use. Determined by cartridge used, or manually from outside.

Filming speed: 18 fps.

Film Drive: Electrically powered micromotor provides continuous automatic filming of the full 15m (50ft.) length of the film.

Power for Drive: Three 1.5V penlight batteries.

Shutter Release: Mercury battery switch with continuous running and safety lock.

Footage Counter: Countable up to 50ft. Automatically resets when new cartridge is inserted.

Film Transport Indicator: For checking film advancement.

Battery Tester: Push-button actuated indicator shows power level of micromotor batteries.

Size: 206 x 101 x 55mm (8 $\frac{1}{8}$ " x 4" x 2 $\frac{1}{8}$ ")

Weight: 1,100 grams (2 lb. 6 $\frac{1}{2}$ oz.)

Accessories: Trigger grip 4, tele-converter 1.6x, etc.

Canon Zoom 318

Similar to model 518, with the following exceptions:

Lens: F 1.8 with zooming range of 10—30 mm. Zoom ratio, 1:3. 10-component, 12-element construction.

Focusing: Zone focus system, set by rotation of front lens.

Viewfinder: Contains 4 prisms and 12-element lens construction.

Body Color: Brown

Size: 199 x 101 x 55mm (7 $\frac{7}{8}$ " x 4" x 2 $\frac{1}{8}$ ")

Weight: 1,050 grams (2 lb. 4 $\frac{3}{4}$ oz.)

Note: No tele-converter is available for this model.

Canon SUPER 8 ZOOM 518

Canon SUPER 8 ZOOM 318

Before using Canon Zoom 518 or 318, load it with the two mercury batteries packed in a separate envelope. If the batteries are not inserted, the electric eye (EE) mechanism will not function.

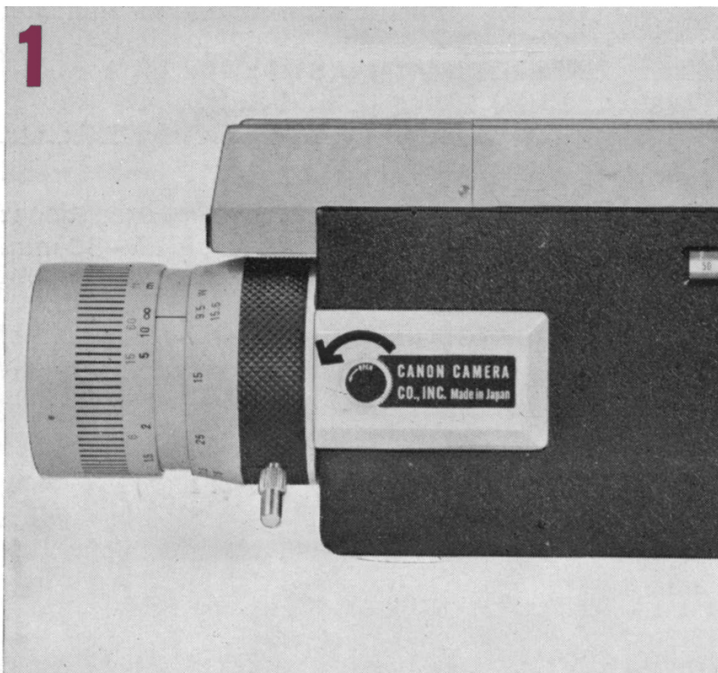

MERCURY BATTERIES

Before inserting the mercury batteries into the camera, wipe all poles clean of all fingerprints or stains with a dry cloth. Unclean batteries may cause corrosion and damage the contact points.

◆ When not in use for a long period, remove the mercury batteries and keep in a dry place.

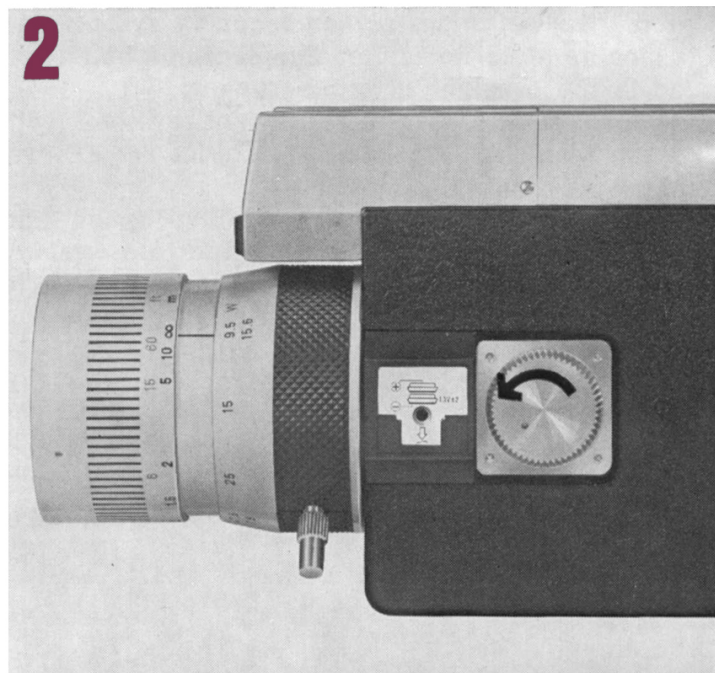

LOADING OF MERCURY BATTERY

- 1** Remove the outer cover of the mercury battery compartment by turning the outer cover knob to the left.
- 2** Remove the inner cover of the mercury battery compartment by turning it to the left.
- 3** Face the central contact side of the two mercury batteries inwards and insert.

4 Screw in the inner cover of the mercury battery compartment by turning it to the right.

5 Attach the outer cover of the mercury battery compartment.

▶ Be sure the mercury batteries are inserted in the correct direction. Otherwise the EE mechanism will not function properly.

3



10

REPLACING OF MERCURY BATTERIES

When the shutter lock dial is set at L the EE circuit is cut off. When set at R or ● the electric circuit is switched on and the exposure meter functions. If the exposure meter needle inside the viewfinder does not move after setting the shutter lock dial at R or ● and aiming the camera at the sky or other bright places, the mercury batteries must be replaced.

➤ Use two 1.3V #625 batteries of the same make — equivalent to Mallory RM 625, Eveready E 625, GE #625, National M-1D, Toshiba TH-MC. A mercury battery can ordinarily be used for one and a half years.

➤ Be sure to replace the two mercury batteries simultaneously.

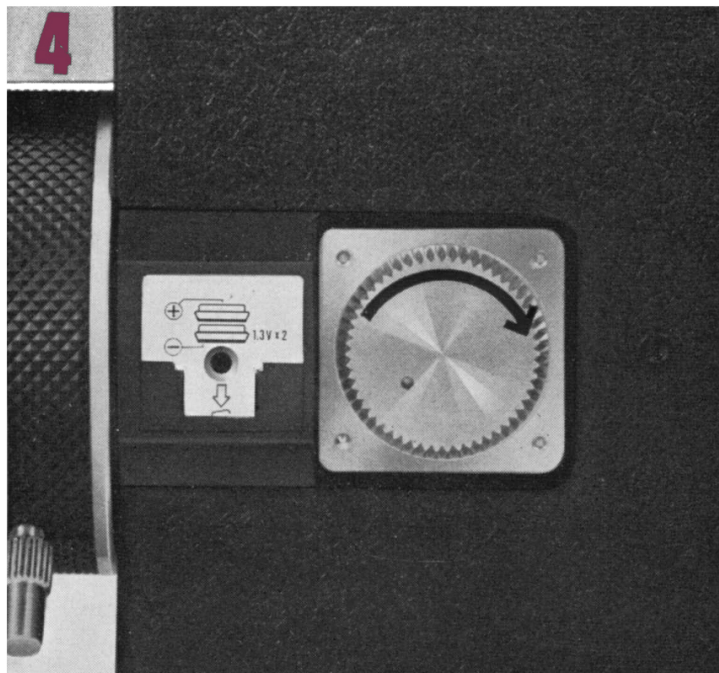

POWER FOR FILM DRIVE AND EYEPIECE ADJUSTMENT

LOADING OF DRY BATTERIES

1 Loosen the battery compartment opening-closing knob by turning it to the left.

2 Remove the top cover by sliding it backwards.

3 Insert three 1.5V penlight (size AA) batteries, with the (+) poles facing towards the front according to the instructions inside the battery compartment.

▶ When the camera is not to be used for a prolonged period of time, remove the dry batteries.

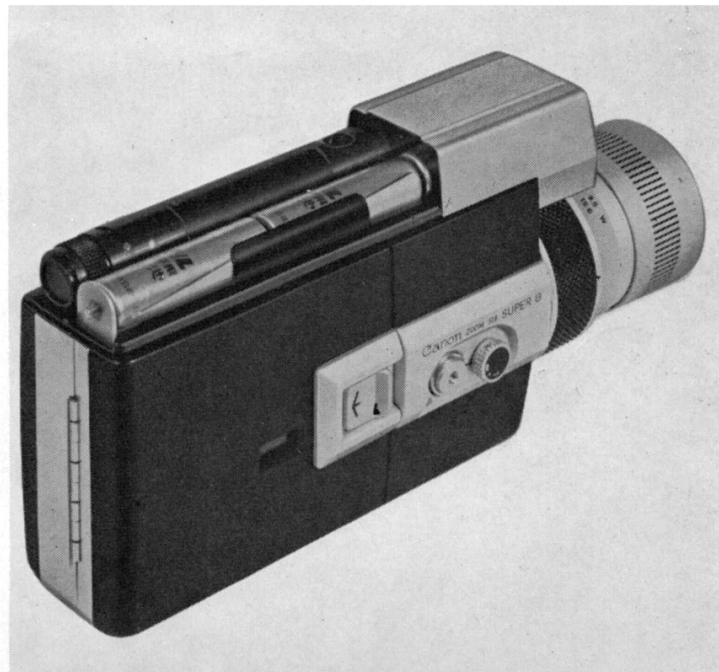

EYEPIECE ADJUSTMENT

Adjust the eyepiece before putting on the top cover.

1 Aim the camera in the direction of a bright light or subject. Then look into the viewfinder while turning the eyepiece adjustment ring and make adjustments so that the aperture stop figures can be clearly seen.

2 After the eyepiece adjustment has been completed, slide the top cover back on and then tighten the battery compartment opening-closing knob by turning it to the right.

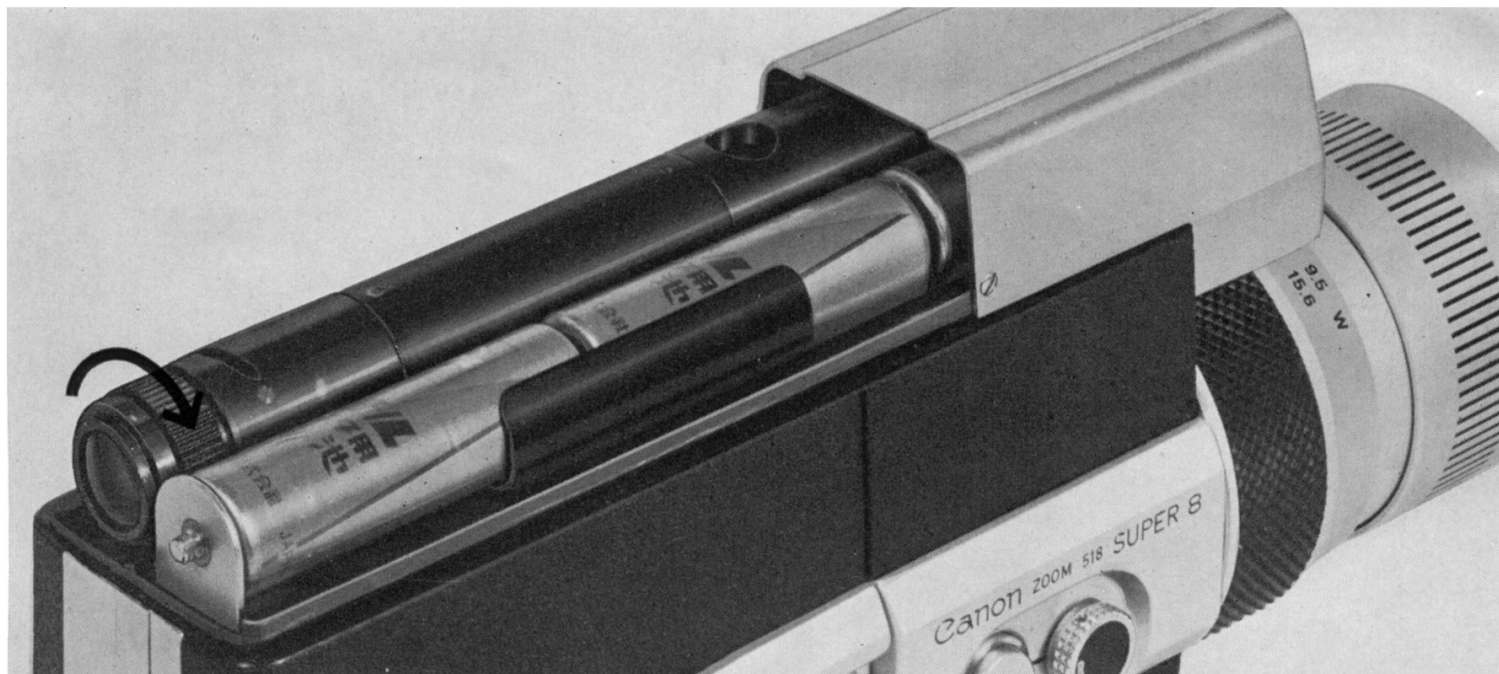

BATTERY CHECK

After the dry batteries have been loaded, check to see whether the capacity of the batteries is sufficient.

1 Press the red button at the bottom of the camera and check the position of the needle seen in the battery test window.

2 If the needle is in the blue zone, it means the batteries have sufficient capacity. If the needle is not in the blue zone, it means the batteries must be replaced.

▶ Always check the battery tester before shooting.

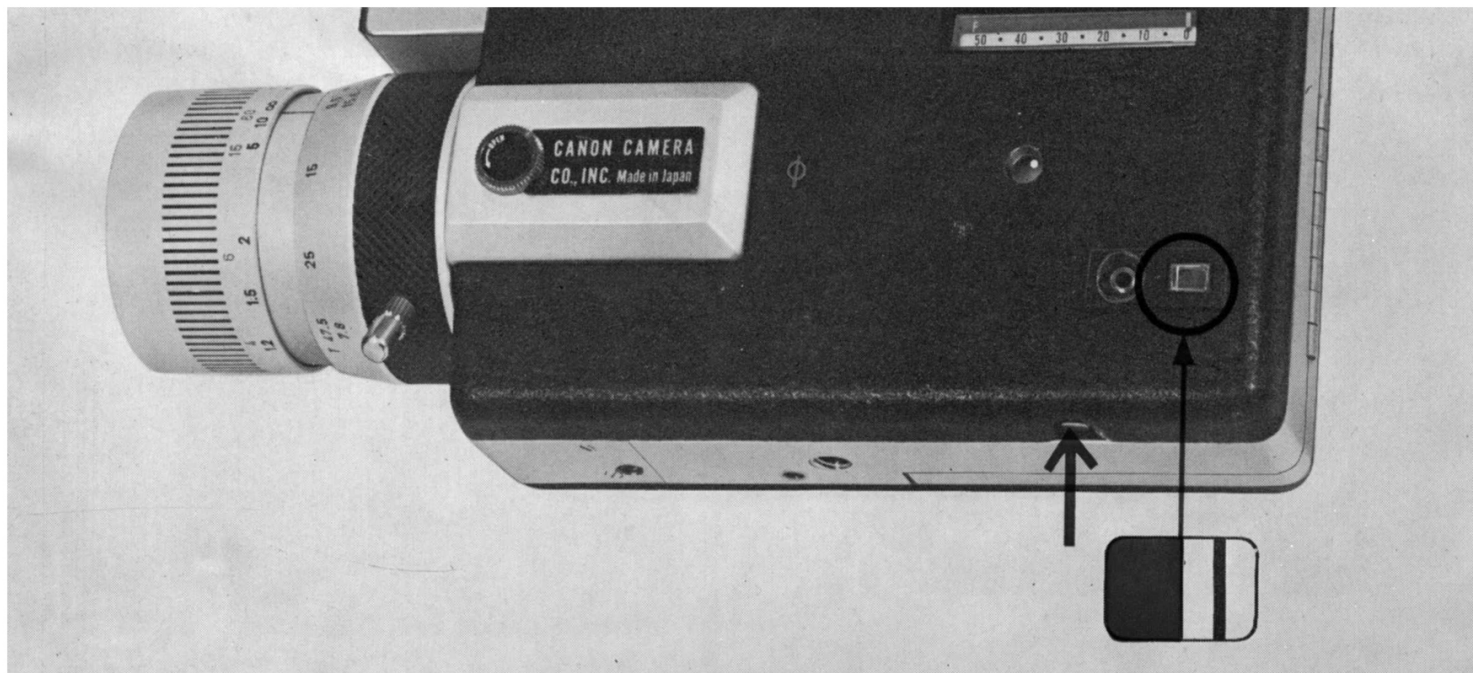

LOADING AND UNLOADING OF FILM CARTRIDGE **SUPER 8**



CANON ZOOM 518

CANON ZOOM 318



- 1** Open the side cover by sliding the side cover latch in the direction of the arrow.
- 2** Slide the Super 8 film cartridge in, right-side-up, towards the front of the camera, and then set the film cartridge into position by pressing down on it.
- 3** Close the side cover by pressing it.

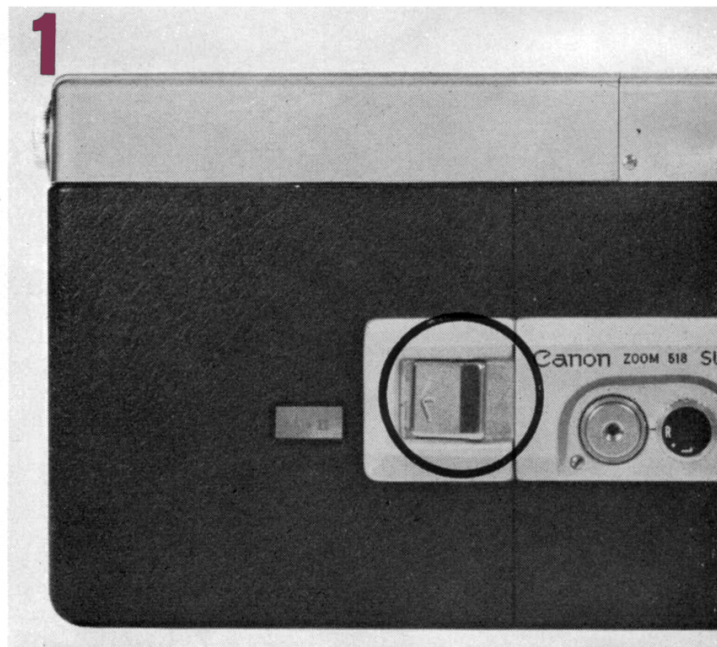

4 Set the shutter lock dial at R and press the shutter button. If a film winding sound can be heard and the white dot in the film transport indicator revolves, it means preparations for shooting have been completed.

5 The super 8 cartridge contains a continuous 50-foot length of film. Stop shooting when the footage counter indicates 50, advance the film

further until F appears, and then take out the cartridge. No flip over or rehandling at the end is necessary.

▶ The footage counter automatically resets to 0 when the cartridge is taken out.

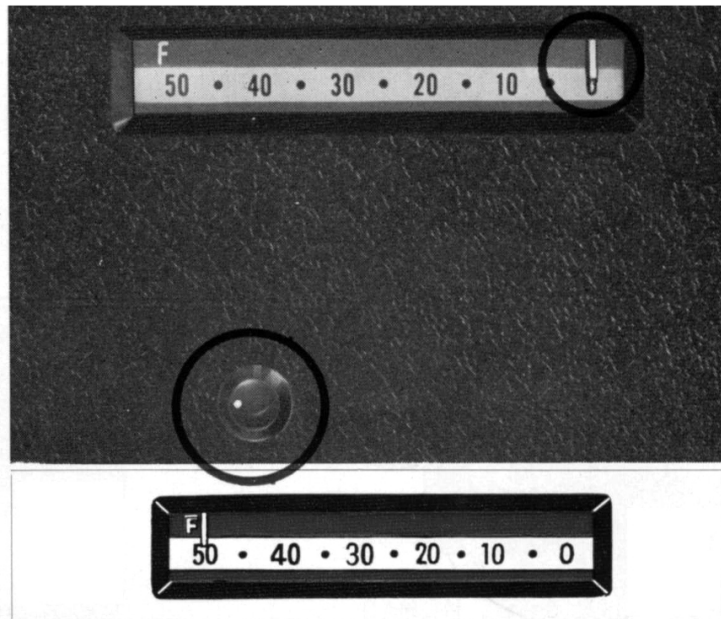
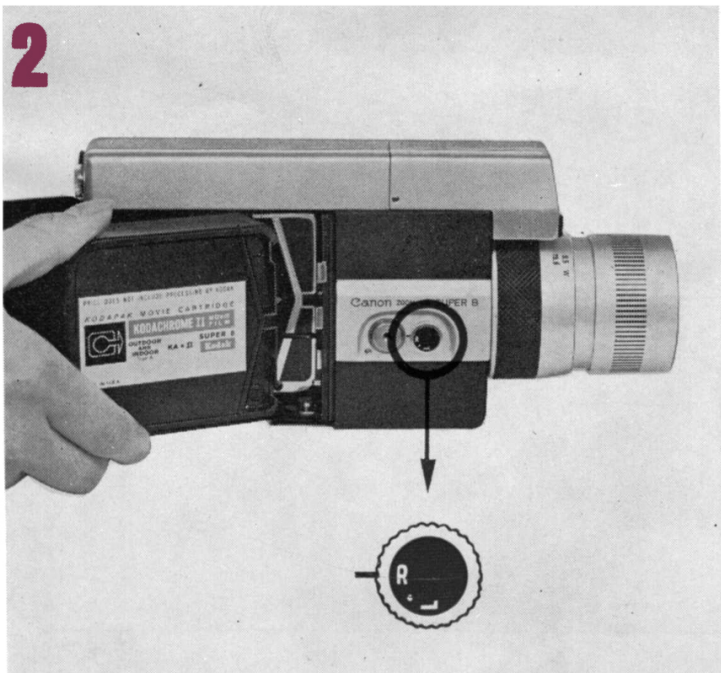

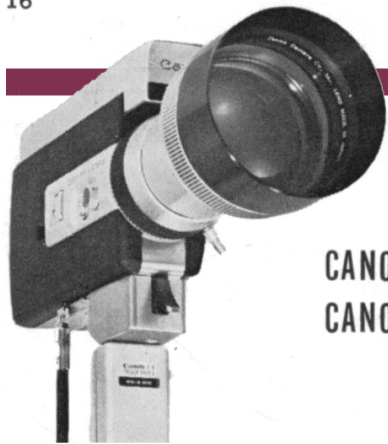

CANON ZOOM 518

CANON ZOOM 318

SHOOTING

SUPER 8

FOCUSING—CANON ZOOM 518

Turn the focusing ring and get the subject into focus. Canon Zoom 518 has a prism screen rangefinder built into the center of the viewfinder. Adjust the focus so that the subject can be seen most clearly through this prism screen rangefinder.

The aligned image can be seen more accurately and easily the longer the focal length of the lens. The

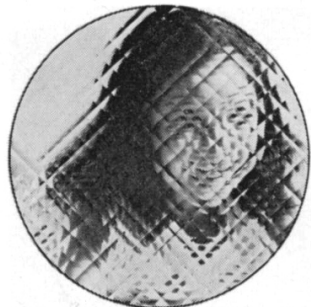

Out of focus



In focus

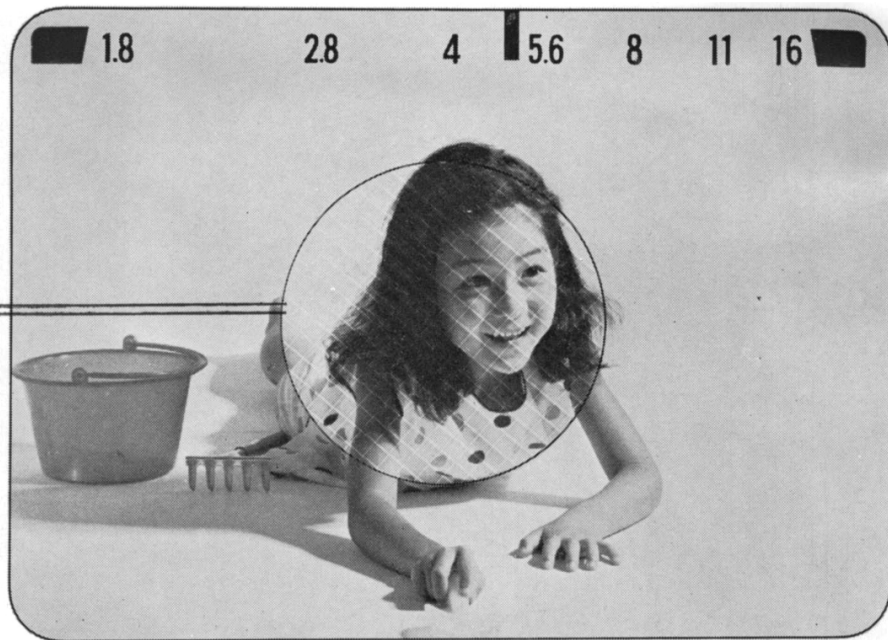

focal point does not change during zooming. Therefore, even when you wish to shoot at low magnification (wide-angle), first focus at maximum magnification (telephoto) and then return to low magnification and shoot.

FOCUSING—CANON ZOOM 318

Estimate the distance from your camera to the subject, and then set the distance by matching the

number on the focusing ring to the indicator line on the lens barrel. Focusing can also be easily performed by using the zone focus marks.



Close distance



Medium distance



Long distance

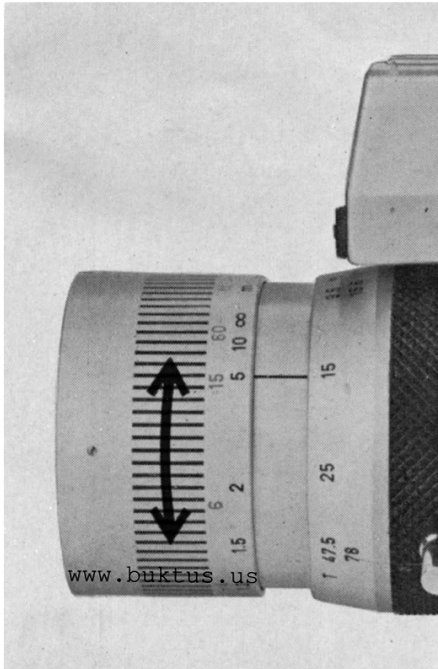

www.buktus.us

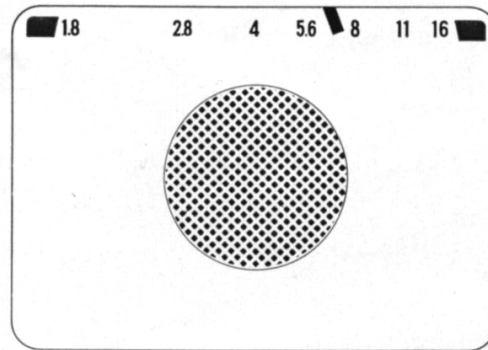

CANON ZOOM 518

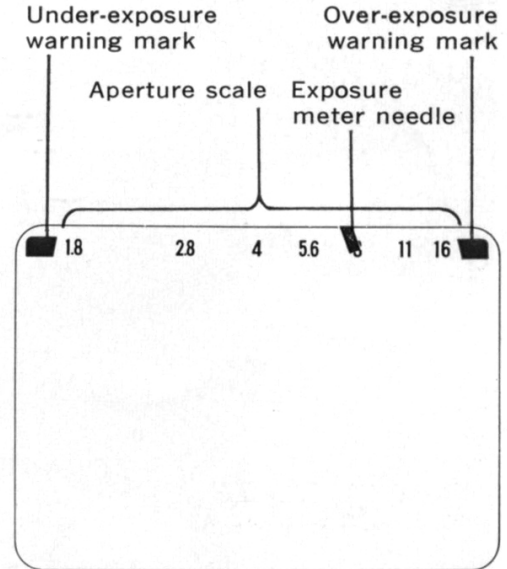

CANON ZOOM 318

◆ The zone focus marks are for determining approximate distances. Thus, even when photographing one person, if the distance from the camera to the person is distant, set the needle to the group or scenery marks.

Use the distance scale for accurate focusing.

ZOOMING

The image seen through the viewfinder will change in magnification and the field-of-view will also change by turning the zooming ring. The field-of-view seen through the viewfinder will be exposed on the film in its entirety. When zooming is performed during shooting, any desired zooming effect can be reproduced on the film.

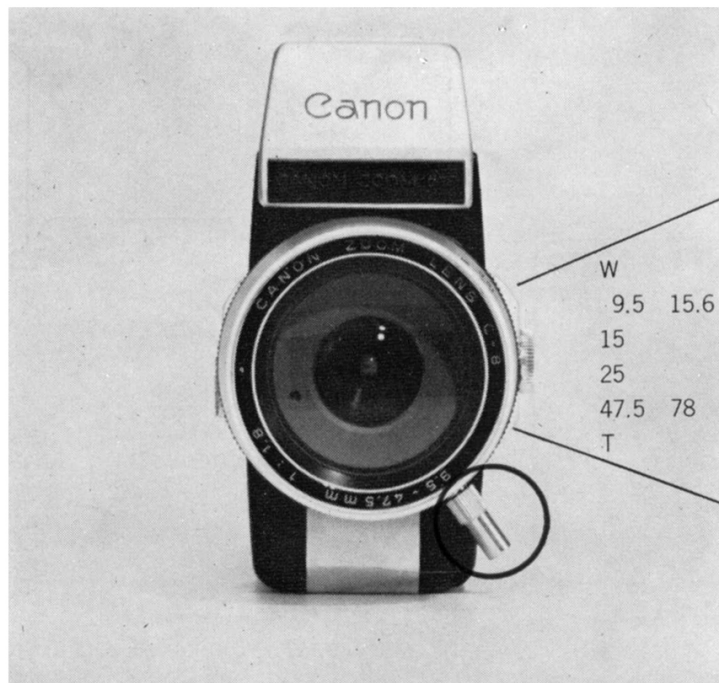

SHUTTER RELEASE BUTTON

When the shutter release button is pressed, shooting starts and the footage counter advances simultaneously. The shutter lock dial must be set at R. The shutter lock dial performs the following two functions :

1 Safety Lock

When the shutter lock dial is set at L, the mercury battery circuit is disconnected. The shutter release button is also locked and prevents inadvertent film advance.



2 Running Lock

Set the shutter lock dial at R and then press the shutter release button. Next, if the shutter lock dial is set at ●, while still pressing the shutter release button, the shutter release button will remain in a pressed down condition even after the finger is taken off the shutter release button.



CABLE RELEASE SOCKET

When shooting movies using a tripod, use the cable release by screwing it into the cable release socket.

2

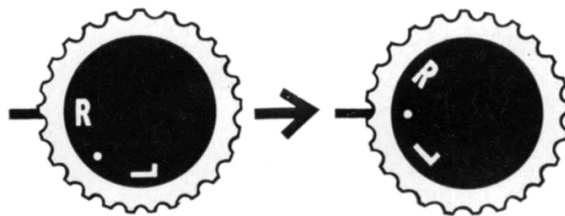

Turn while pressing the shutter release button.

ACTUAL SHOOTING AND WARNING MARK **SUPER 8**

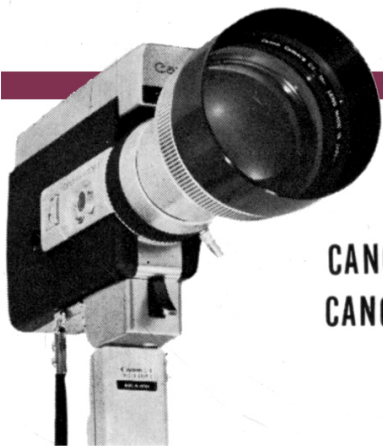

CANON ZOOM 518

CANON ZOOM 318

Canon Zoom 518 and 318 are completely automatic cameras. Exposure adjustments or film speed settings are absolutely unnecessary.

Before pressing the shutter release button, aim the camera at the subject and check the position of the exposure meter needle inside the viewfinder. If the needle is pointing somewhere within the range of the aperture scale, you can press the shutter release button. It means the exposure meter needle is

Insufficient exposure

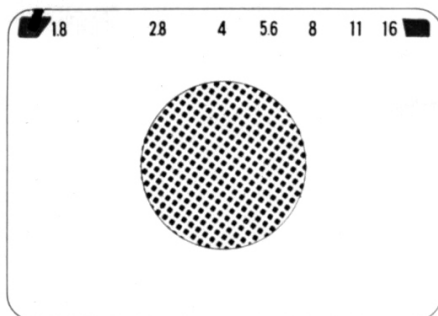

Proper exposure

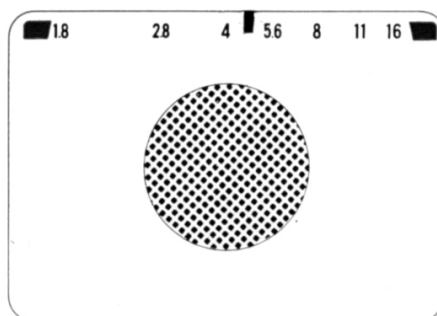

Use ND filter

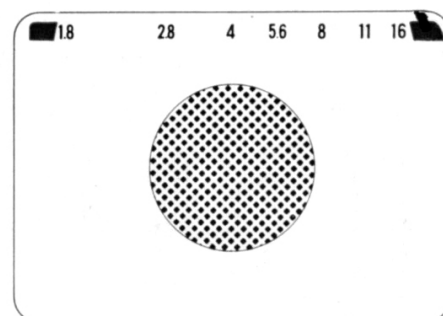

pointing to the proper aperture stop.

Warning Mark

If the exposure meter needle is pointing to either of the red warning marks on both sides of the aperture scale, shooting under proper exposure conditions is impossible. However, if the needle is pointing to the over-exposure warning mark on the right side, shooting will become possible if an ND filter is

attached in front of the lens to restrict the light intensity.

▶ When checking the exposure meter needle, remember that the needle will not move unless the shutter lock dial is set at R.

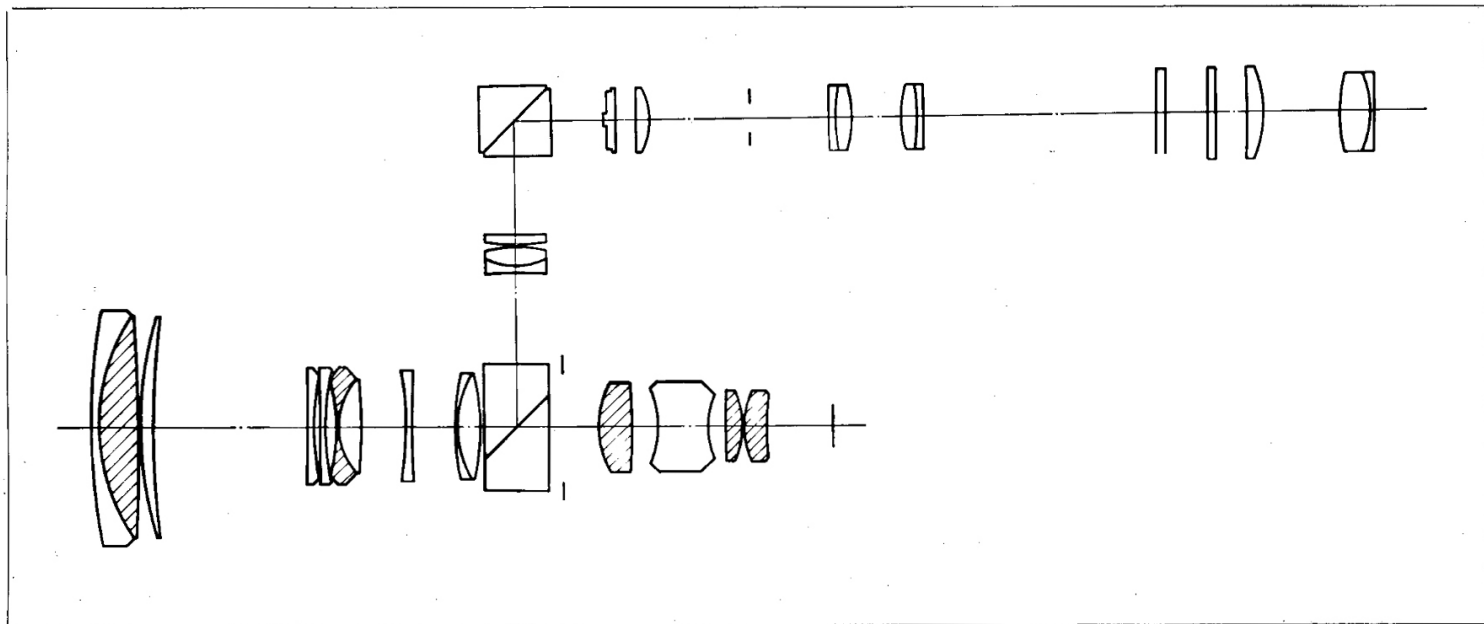

USE OF ACCESSORIES

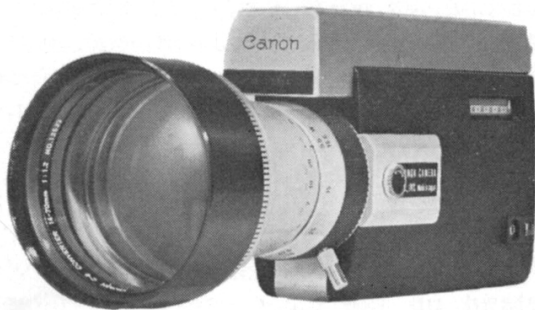

FOLDING TYPE TRIGGER GRIP

The shutter can be released while firmly holding the camera by the trigger grip. Use of the trigger grip is recommended for easier handling.

1 Unfold the grip, align the connecting parts of the grip and camera, and attach the grip onto the camera by screwing the attachment screw into the tripod socket.

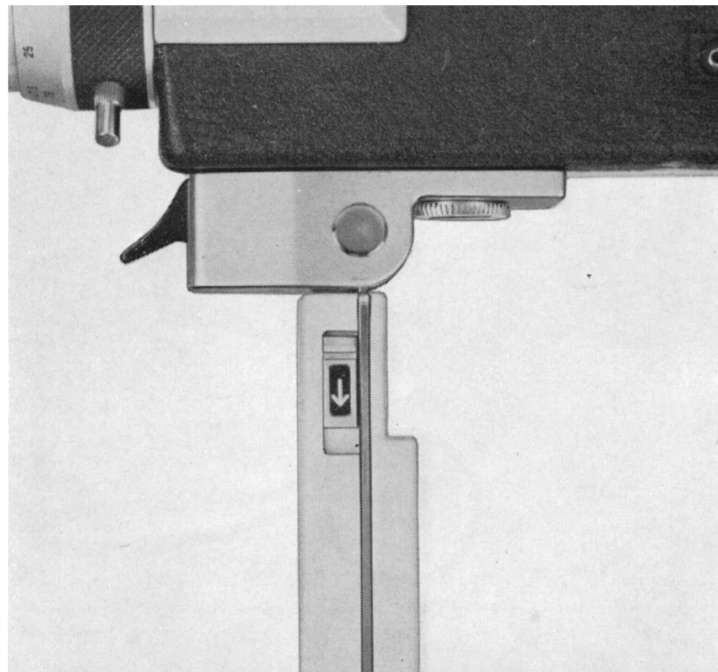
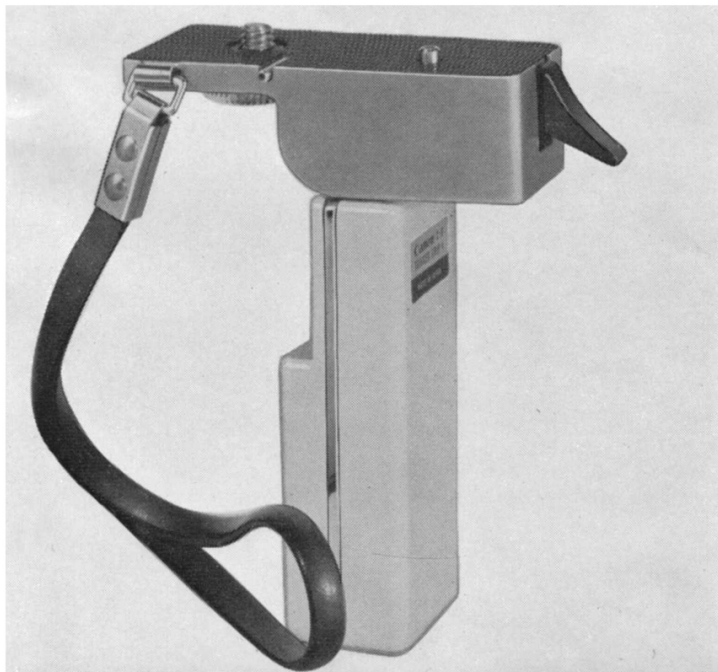

2 Hold the grip with the right hand and pull the trigger. The shutter will function and the film will advance.

3 When folding the grip, pull the lever downwards.

4 TRIGGER GRIP AND COLOR TEMPERATURE CONVERSION

When tungsten type film is used for daylight shooting, a Color Conversion A type filter for con-

verting the color temperature becomes necessary. To eliminate the trouble of attaching a filter every time you want to shoot in daylight, a Color Conversion A type filter has been built into the optical system of the camera. Thus, for daylight shooting with tungsten type film you use the camera as it is.

In case you want to shoot under artificial lighting, stand up the color conversion filter cancellation

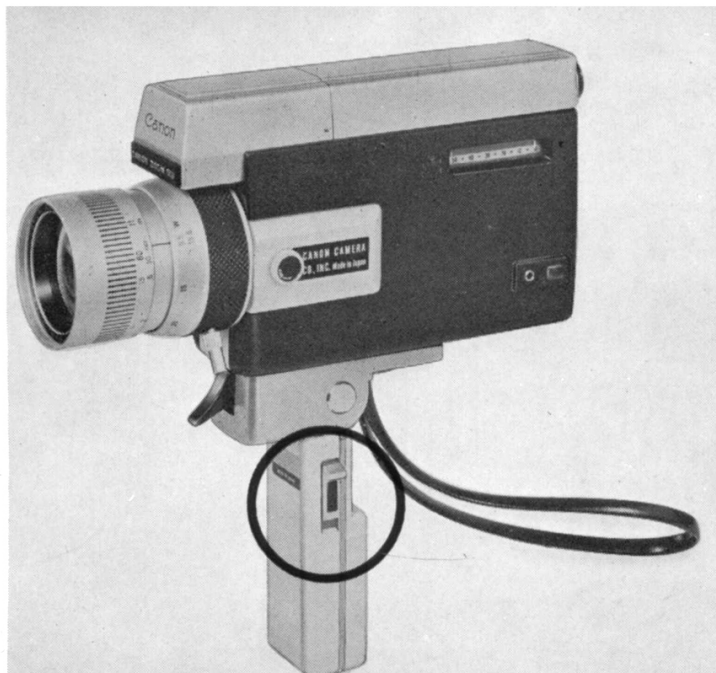

pin of the grip before attaching it onto the camera. This pin will eliminate the built-in Color Conversion A type filter from the optical system and shooting under artificial lighting becomes possible. Use of blue lamp is not necessary. You may use ordinary flood lamps or spotlights.

◆When the grip is not attached to the camera, or when the grip is attached to the camera with the color conversion filter cancellation pin folded, the camera is set for daylight shooting.

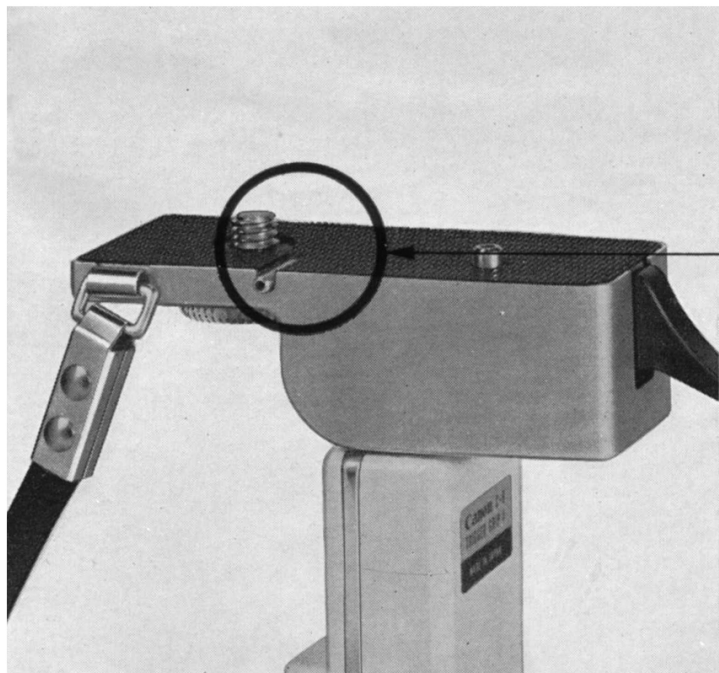

Please bear in mind that proper color photography cannot be performed if the above-mentioned manipulations are not followed correctly.

◆When using black and white or daylight type color films, the Color Conversion A type filter is automatically eliminated with the insertion of the film cartridge. When shooting under artificial lighting with daylight type color film, use blue lamp or Color Conversion B type filter.

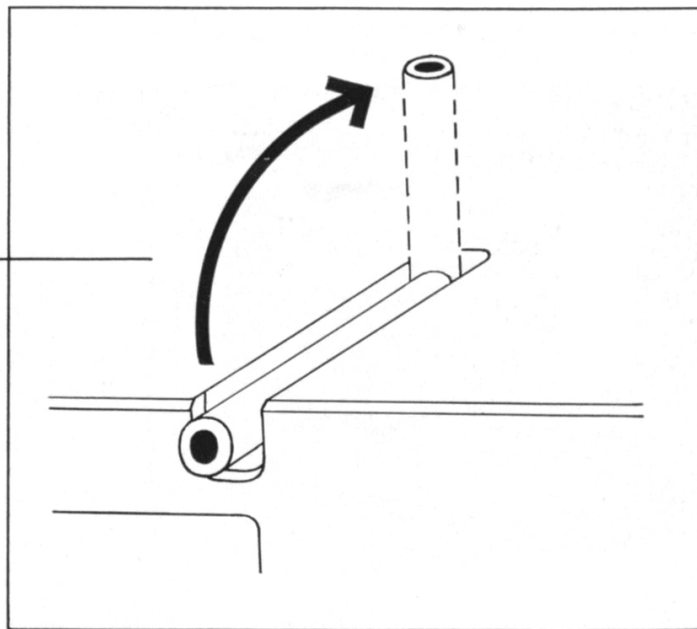

REMOTE CONTROL SWITCH

With the use of the remote control switch you can operate the camera from a distance.

- 1** Insert the plug of the remote control switch cord into the remote control switch socket of the camera.
- 2** Set the shutter lock dial at \cdot , while pressing the shutter release button, to set the camera in running lock condition.



- 3** When the release button of the remote control switch is pressed down and slid in the direction of the arrow, the film advances and is set into running lock condition.

◆ When disconnecting the cord of the remote control switch from the camera, be sure to return the shutter lock dial of the camera to R first. If the cord of the remote control switch is disconnected from the camera before the shutter lock

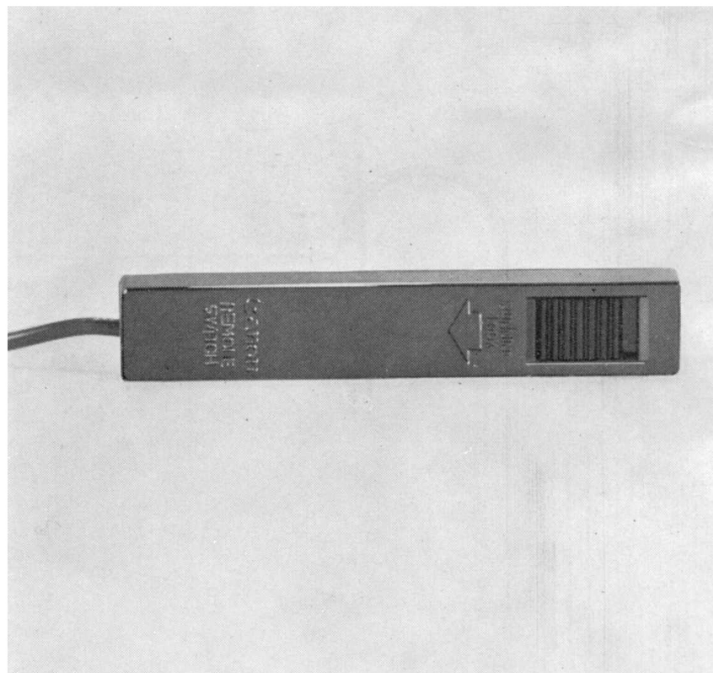

FILTERS

dial is set at R, the shutter will actuate and the film will start advancing.

◆ The length of the cord for the remote control switch is 8 meters.

◆ When shooting pictures with the remote control switch, it is better to check the general conditions of the subject or its immediate surroundings before pressing the shutter release button. Also, cover the eyepiece with a handkerchief or some other convenient material to shut out bright light.

48mm screw-in type filters for Canon Zoom 518 and 318, and 72mm screw-in type filters for the converters are available.

In the Canon Zoom 518 and 318, the light passing through the optical system of the lens is measured by the TTL system exposure meter. Therefore, any type of filter most suited for a certain purpose can be freely chosen without regard to the exposure factor.

Type		Effectiveness of Filters
UV (SL 39 · 3C)	For monochrome and color	Absorbs only ultra-violet rays. Especially effective at seaside and high mountains. Recommended for use in color photography.
Y1 (SY 44 · 2C)	For monochrome	Increases contrast of monochrome film.
Y3 (SY 50 · 2C)	For monochrome	Slightly brightens red and yellow.
O1 (SO 56 · 2C)	For monochrome	Good for contrasts, especially in distant landscapes.
R1 (SR 60 · 2C)	For monochrome	Makes strong contrasts. May also be used with infra-red film.
G1 (MG 55 · C)	For monochrome	Prevents red from turning radically into white. Lightens faces and sky appropriately, and reflects the brightness of fresh greenery as seen with the naked eye.
Skylight	For monochrome and color	Acts to harmonize the blue sky and shade.
ND4 } ND8 }	For monochrome and color	ND4 reduces light volume by 1/4, ND8 by 1/8. Has absolutely no effect on the reproduction of colors of color film.
Color Conversion B	For color	Color temperature conversion filter for use with daylight type color film under tungsten light.

TELE-CONVERTER

The Canon C-8 Converter is an attachment for the taking lens of Canon Zoom 518 to convert it into a telephoto zoom lens. In this case, the converted magnification range or focal length becomes 15.6—78 mm, making possible shooting in a wide range, from standard to telephoto.

Lens Speed : F 1.8

Zooming Ratio : 5

Zooming Range : 15.6—78 mm

Lens Structure : 4 components, 5 elements, afocal system.

Distance Scale :	ft	50	30	20	15	12	10
		∞					
	m	20	10	7	5	4	3

Infinity setting window



Coating: Purple spectra coating
 Filter Size: 72mm
 Cap Size: 80mm
 Hood: Built-in type
 Size: Overall length—80mm (3 1/8")
 Maximum diameter—80mm (3 1/8")
 Weight: 420 grams (15 oz.)

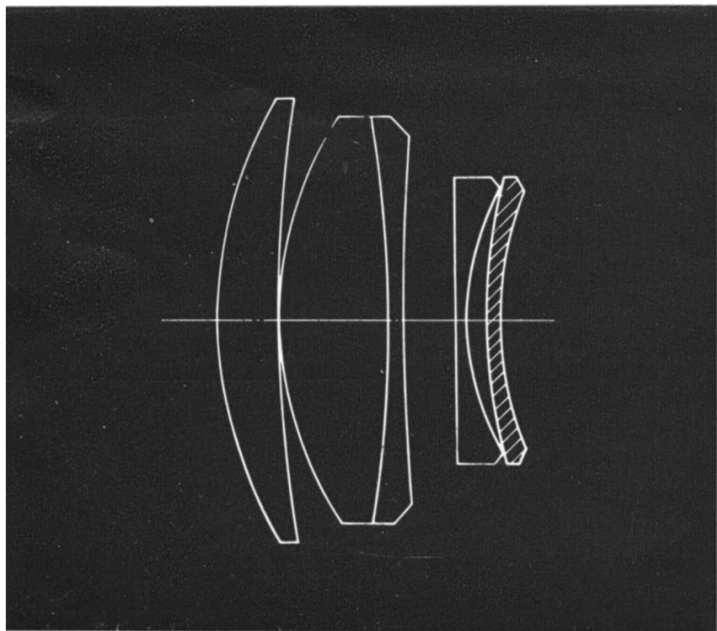

Method of Attaching

- 1** Remove the back cover of the converter and attach the converter over the taking lens of the camera.
- 2** Turn the lens barrel of the converter and screw the converter into the front panel of the shooting lens.
- 3** Loosen the tightening screw of the converter's distance ring.

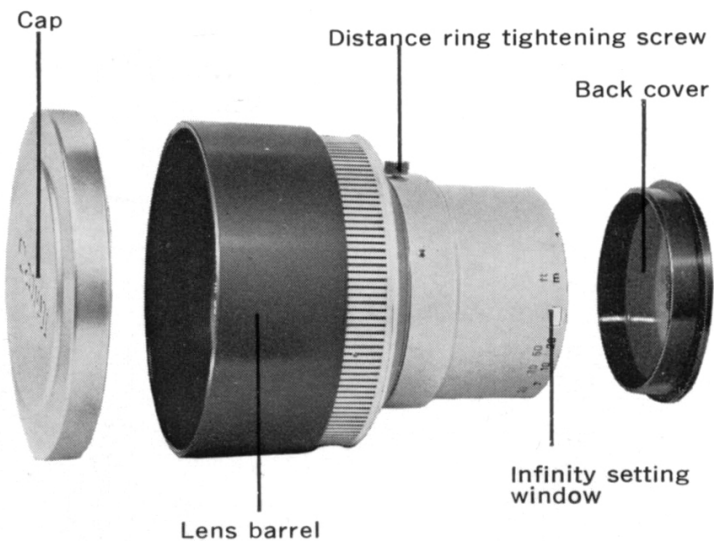

4 Turn the distance ring of the converter so that the infinity mark appears in the distance ring window. Fix the distance ring securely with the tightening screw.

5 Pull out the built-in hood.

6 Zooming and focusing are carried out in the ordinary manner.

Without converter



With converter

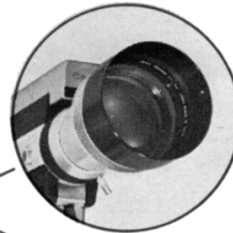

48mm CLOSE-UP LENS 450

The close-up lens is designed for titling, reproduction of documents, photographing of plants and insects, etc. Attach the close-up lens, and when the distance scale is adjusted to ∞ , the distance from the tip of the lens to the subject is 450mm.

STORING THE CAMERA

Keep the camera away from dampness, heat, and dust when storing. Do not place the camera near naphthalene or camphor. While it is not necessary to oil any part of the camera, a periodic overhaul and cleaning will prolong its life.

► When storing the camera in the case, turn the safety lock of the shutter to L.



FIELD-OF-VIEW OF 48mm CLOSE-UP LENS 450

	48mm Close-up Lens 450			
Focal length	9.5mm		47.5mm	
Distance scale	∞	1.2m (4')	∞	1.2m (4')
Distance from film plane to subject	580mm (1' 10 ¹³ / ₁₆ ")	450mm (1' 5 ⁷ / ₈ ")	580mm (1' 10 ¹³ / ₁₆ ")	450mm (1' 5 ⁷ / ₈ ")
Field-of-view	259 × 192mm (10 ³ / ₁₆ " × 7 ⁹ / ₁₆ ")	173 × 129mm (6 ⁷ / ₈ " × 5 ¹ / ₁₆ ")	52 × 38mm (2 ¹ / ₁₆ " × 1 ¹ / ₂ ")	35 × 26mm (1 ³ / ₈ " × 1")

PANNING

Panning is employed when shooting a picture from one position to another by moving the camera around horizontally to make a continuous shot over a wide area in one sequence.

▶ Do not move the camera too rapidly in any direction, particularly vertically. Use of a tripod is therefore recommended.

▶ It is important, when shooting panoramic pictures, to move the camera at a constant speed.

▶ When following a fast-moving subject with panning, try to keep the subject in the same position in the viewfinder.

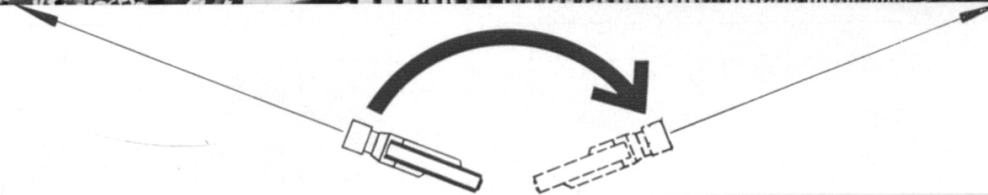
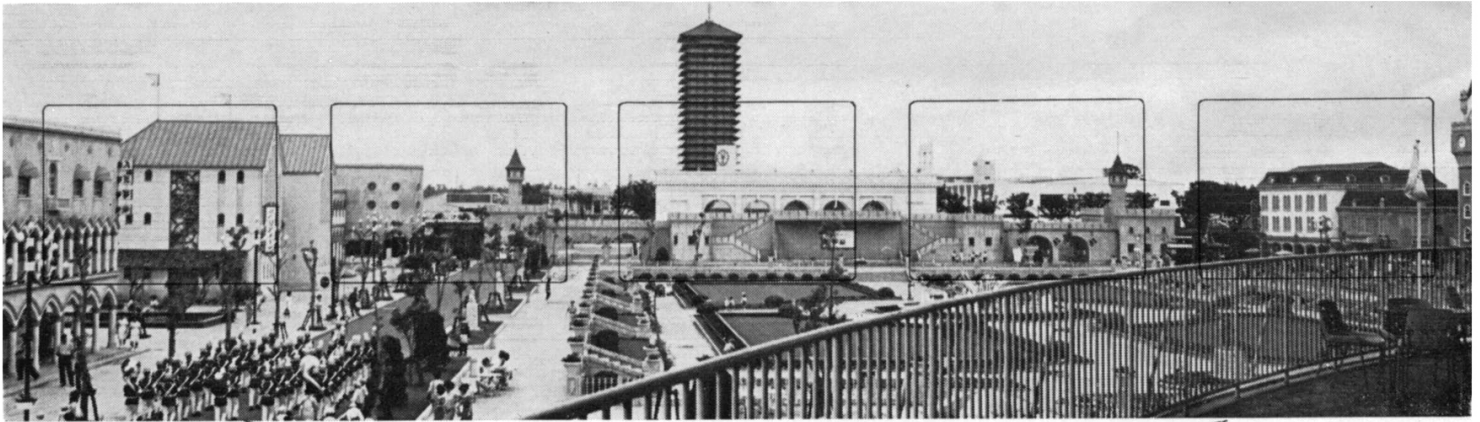

CANON P-8 CINESTAR S

Here is a compact 8mm projector that can show either regular 8mm film or the new Super 8 size. Operation is fully automatic. Insert the film end into the projector, turn the switch, and the film will run completely through and rewind . . . with no need for resetting or touching any other switches. It has a fast 15–30mm F 1.5 zoom lens, 8V 50W mirror lamp, adjustable filming speeds from 10 to 20 fps., a built-in power cord, a plug for a room light and

a projection screen built into its side cover. It accepts six different line voltages—100, 115, 125, 220 or 240 volts.

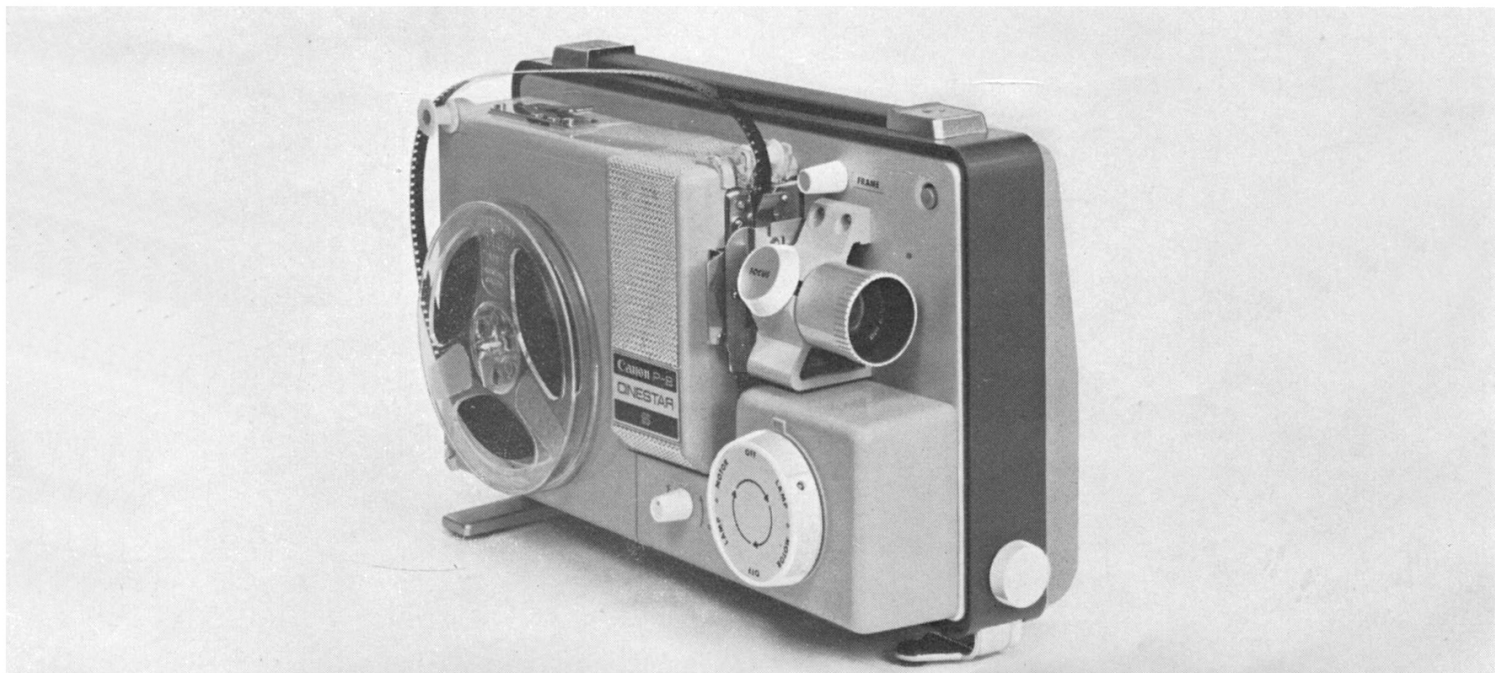

Focusing Ring

Zooming Lever

Indicator Line

Release Socket
Coupled with
Trigger Grip

Socket for
Changing Color
Conversion Filter

Knob for
Outer Cover
of Mercury
Battery
Compartment

Tripod Socket

Battery Test
Button

Film Position
Mark

Remote Control
Switch Socket

Film Transport
Indicator

Footage
Counter

Battery Tester

Battery Compartment
Opening-Closing Knob

Eyepiece

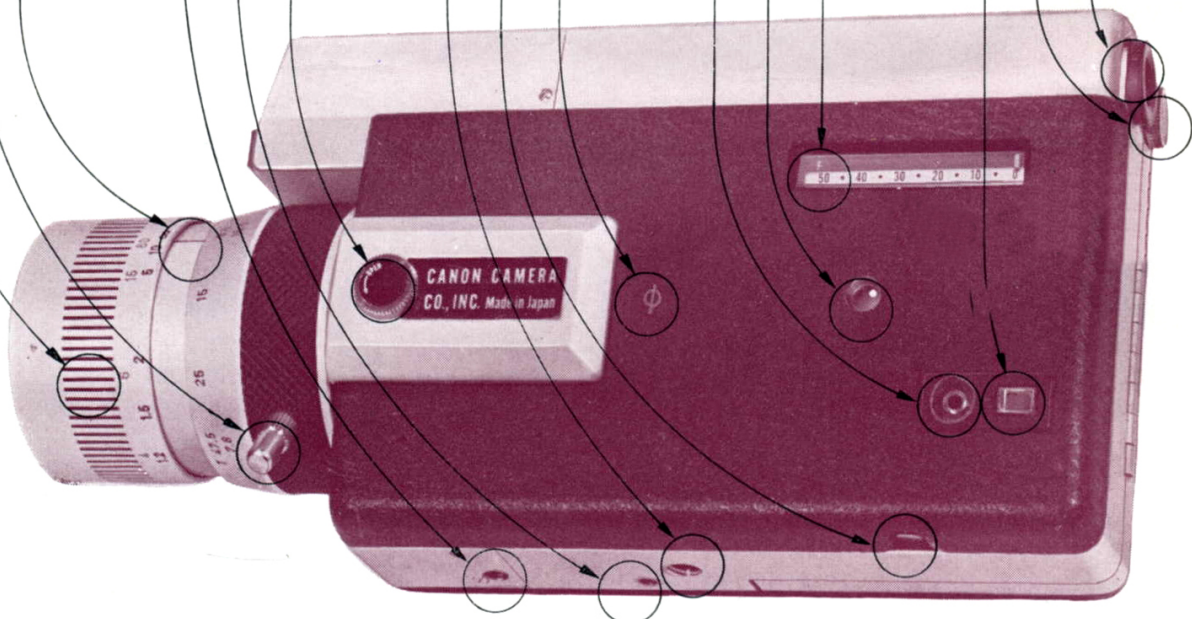



CANON CAMERA CO., INC.

3 Ginza 5 - chome, Chuo-ku, Tokyo, Japan

CANON USA., INC.

554 Fifth Avenue, New York, New York 10036, U.S.A.

CANON S.A. GENEVE

1, Rue de Heese, Geneva, Switzerland

CANON LATIN AMERICA S.A.

Apartado 7022, Panama 5, Panama

