

DEALER PRICE CATALOG



CONFIDENTIAL

ILLUSTRATED DEALER PRICE LIST

CONFIDENTIAL



CAMERAS
FILMS
PAPERS
CHEMICALS
ACCESSORIES

ISSUE A-1

Effective September 1, 1960



AS AN Agfa Franchised Dealer has it occurred to you what the Agfa name and trademark represent to you and your trade? Agfa is a registered photographic trademark since 1897. Since its beginning over 60 years ago, Agfa is known and respected for the quality and preciseness of its product, its consistent pioneering in photographic research and the vastness of its operations throughout the world.

Agfa cameras, projectors, enlargers, film, paper and chemicals are sold in over 140 countries; Agfa Incorporated, New York City is one of the largest distributors of photographic merchandise imported into the United States and originating from one manufacturer.

Below you see the Leverkusen Factory (Western Germany) and the just recently completed Agfa Research and Progress Center at the Munich camera plant, which is now the most modern scientific edifice of its kind in Europe.

Agfa and its staff of over 10,000 is dedicated to the concept that if photography, as a science and industry, is to continue to grow and prosper then through research new horizons should be explored, new ideas be pursued and new techniques be developed.

As an Agfa Franchised Dealer we are delighted and proud to have you on our team.

*14 stories tall
170 feet
above street level
80,700 sq. feet
of effective space*

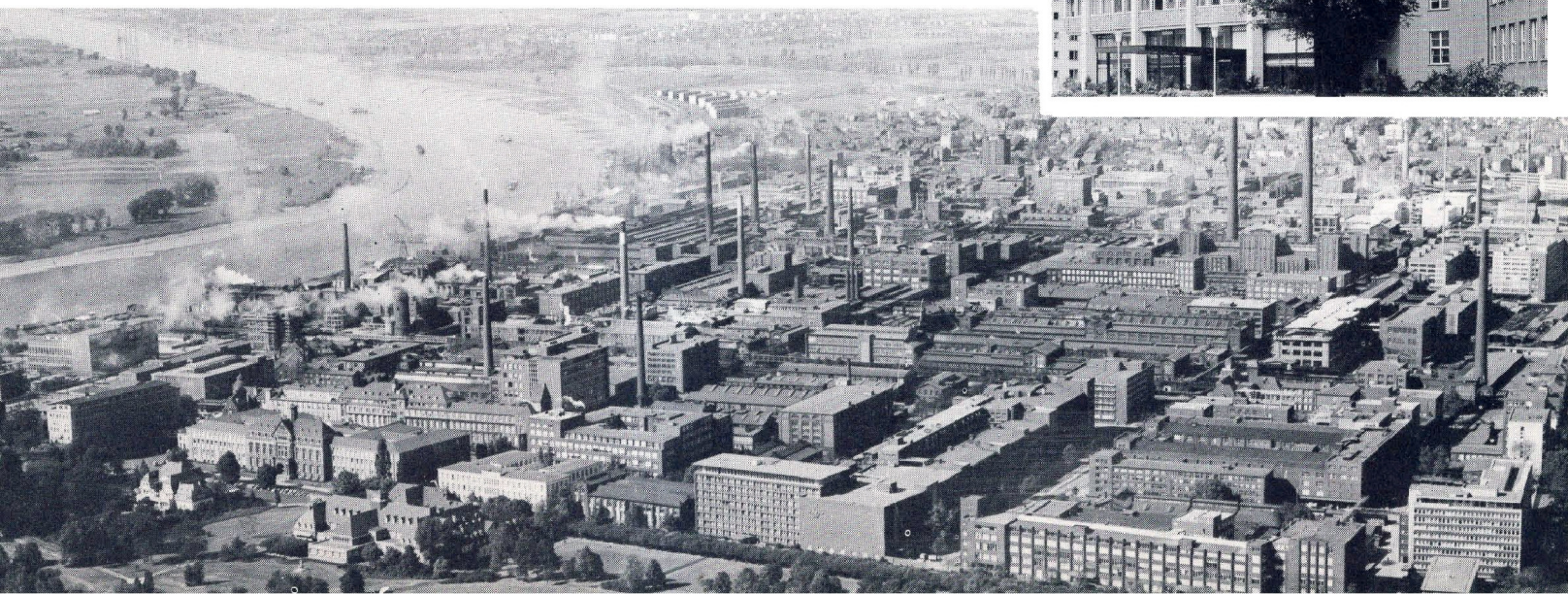

INDEX

SECTION

CATEGORY

1

STILL AND MOVIE CAMERAS

2

CAMERA ACCESSORIES

3

STILL AND MOVIE PROJECTORS

4

DARKROOM EQUIPMENT

5

OPTICAL GOODS

6

FILMS

7

PHOTOGRAPHIC PAPERS

8

CHEMICALS

9

AGFA MAGNETIC TAPE

10

DEALER SUPPLIES AND SALES AIDS



CONDITIONS OF SALE

1

The NET PRICES in this price list are available only to AGFA Franchised Dealers. All prices are subject to change without notice. Adjustments if any are made exclusively at our discretion.

2

The applicability of BASIC NET PRICES and QUANTITY NET PRICES (see code) as indicated in this net price list depends on the size of the order placed for shipment at one time to one place. Back-ordered items are charged for according to the net prices applicable to the original order from which such items were separated.

3

On ORDERS LESS THAN \$10.00 NET there is a HANDLING CHARGE of 50¢.

4

The TERMS are 2% discount for payment received on or before the 10th of the month following the date of invoice. All bills due net thereafter. No anticipation allowed.

5

SHIPPING POINTS: AGFA INC., Eastern Sales Division, 516 West 34 Street, New York 1, N. Y., (Phone: PE 6-2830); AGFA INC., Western Sales Division, P.O. Box 3514, Glendale 1, California (Phone: CH 5-5820).

6

TRANSPORTATION is FREE on all orders for merchandise shown in this price list, totalling \$200.00 or more after application of all quantity discounts and calling for one shipment to one destination. All BACK ORDERS are shipped free of transportation charges.

7

For all orders shipped without transportation charges the carrier is selected by us. If more expensive routing is requested, the customer will pay the difference in transportation cost.

8

No RETURNS are accepted for credit or replacement without our prior approval —IN WRITING. A 10% handling charge is made for all returns for credit.

9

On OUTDATED SENSITIZED MATERIAL returned within two weeks of its expiry date a credit of 20% of the list price is allowed.

10

All basic matters guiding our supplier-retailer relationship are outlined in the AGFA RETAILER FRANCHISE AGREEMENT.

September 1, 1960
AGFA INCORPORATED

NET PRICE CODE EXAMPLE:

(0401	19-97)	(3+	0401	17-97)
Product	Basic	Minimum	Product	Quantity
Code	Net	Quantity	Code	Net
	Price	for Quantity		Price
		Net Price		

THE PLUS SIGN INDICATES THAT THE NET PRICE APPLIES TO THE INDICATED QUANTITY OR MORE

WORLD FAMOUS AGFA CAMERAS



Presenting the New Agfa Silette I and Silette L

These popular Agfa Silettes feature the "new look" in 35mm cameras: smaller, neater than before, simpler and easier to use than ever. Either model is perfect as a "first" camera for the amateur or as a completely dependable and versatile "second" camera for the advanced photographer. There is no better value in a low cost quality camera than either the Agfa Silette I or the Silette L.

This is the camera designed with amateur needs in mind! Box camera simplicity but with quality design. Features sharp, color-corrected Agfa Color-Agnar 45mm F/2.8 lens in Prontor shutter with speeds to 1/125 second.

Provides the now famous SYMBOLS focusing system with feet and meter distance markings added. New type rewind lever with folding crank permits fast rewinding of film with non-slip action. A large built-in optical viewfinder assures accurate composition of subject matter even under poor lighting. Built in Flash Contact shoe accepts Agfa flash units.

Item	Product No.	List Price
Agfa Silette I Camera	(2605/276 19-97) (3+18-49 12+16-17)	\$29.95
Case for Agfa Silette I	(6114/0000 4-88) (3+ 4-63 12+ 4-05)	7.50

Silette I can be assorted only with Silette L.

AGFA SILETTE I

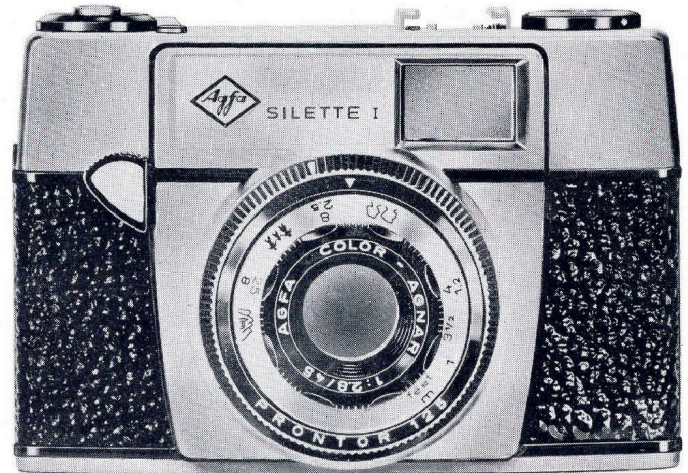

AGFA SILETTE L

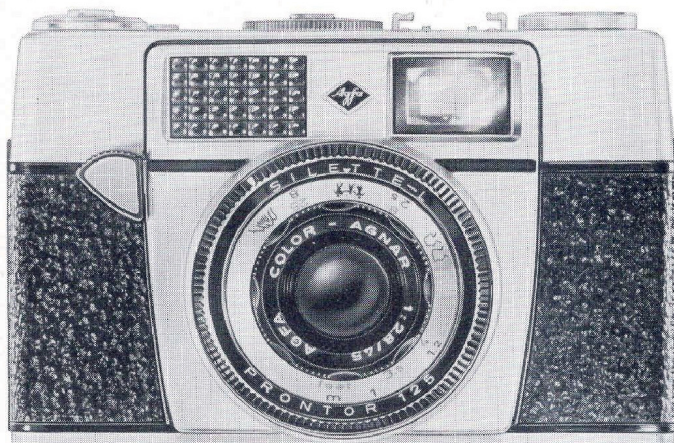

The Agfa Silette L will please even the most discriminating color slide fan because it is engineered and designed with color in mind to produce clean, sharp, brilliant color photographs.

Good exposure is assured through a built-in accurate exposure meter and accurate Prontor shutter. Sharp brilliant pictures are assured through the time-proven Agfa Color-Agnar 45mm F/2.8 lens. Accurate composition of subject matter is assured through the built-in bright-line view finder system. The Agfa Silette L also has many of the other quality refinements that have made Agfa cameras famous throughout the world.

Item	Product No.	List Price
Agfa Silette L Camera	(2609/276 32-47) (3+30-84 12+26-97)	\$49.95
Case for Agfa Silette L	(6114/0000 4-88) (3+ 4-63 12+ 4-05)	7.50

32mm filters and lens shades are available as optional accessories for the Silette I and Silette L.

Silette L can be assorted only with Silette I.

AGFA CLACK

Introducing a new Agfa box camera that sells at very low cost yet produces excellent photographs in black and white or color, and offers extra features not available in any other camera of this type.

- Extra Value #1**—Sturdy, all-metal body for lifetime use.
- Extra Value #2**—Easy-to-see 2¼ x 3¼ picture on #120 films.
- Extra Value #3**—Two lens openings for normal and extra bright light gives better exposure to today's fast films.
- Extra Value #4**—Built-in flash for round-the-clock shooting.
- Extra Value #5**—Built-in yellow filters for clouds—no more blank skies.
- Extra Value #6**—Two-point distance setting for sharper pictures.
- Extra Value #7**—Permanent strap for easy-carrying.

Item	Product No.	List Price
Agfa Clack Camera	(0620/000 6-63) (6+5-97 12+4-97)	\$9.95
Case for Clack	(6042/000 1-97) (6+1-77 12+1-47)	2.95
Agfa Clibo Flashgun for M2 socket without case	(6866/000 2-63) (6+2-37 12+1-97)	3.95

Neither the Agfa Clack or the Clibo Flash Gun can be assorted with any other camera or flash gun.





NEW SILETTE I AND SILETTE L GIFT SETS



Now available: Silette I and Silette L Cameras tastefully gift-boxed. Supplied with protective sleeve.

Contents
SILETTE I CAMERA
 Eveready Camera Case
 Isi-Flashgun
 1 Agfachrome CT 18 135-20
 Deluxe Gift Box

Contents
SILETTE L CAMERA
 Eveready Camera Case
 Isi-Flashgun
 1 Agfachrome CT 18 135-20
 Deluxe Gift Box

Ideal for all gift-giving occasions: Graduation, Mother's Day, Father's Day, Weddings, Anniversaries, Birthdays, Christmas.

	Dealer Net	Value	Promotional List	Consumer Saves
Silette I Kit	(24-34) 6+23-13)	\$46.35	\$37.45	\$8.90
Silette L Kit	(37-34) (6+35-48)	66.35	57.45	8.90

NOTE: Don't forget the Battery and Flashbulbs.
 For technical information on the above items see pages 1 and 14.

WORLD FAMOUS AGFA CAMERAS

The Agfa Selecta brings to automatic photography a new concept, the idea of "selective automation." The photographer can now decide what range of shutter speeds or lens openings he needs, adjust his Selecta accordingly and achieve his desired result automatically, accurately, quickly.

What does "selective automation" mean?

1. The lens stop settings appear in the green signal of the viewfinder. On pressing the release button the red signal in the viewfinder changes to green. The numbers of the lens stops then run past in the green signal. As soon as the lens stop number halts, the lens stop is fixed and set. The exact stop (set continuously) can be read from a mark in the green signal. If the button is pressed down further this releases the shutter.
2. The shutter speeds from 1/30 to 1/500 sec. can be set continuously. Colored symbols for weather and lighting conditions facilitate fast selection:
 - a) **Blue field:** For medium shutter speeds which are generally used in good light and prevent blurred pictures.
 - b) **Black triangle:** For automatic photography under poor lighting conditions (slow shutter speeds) or for exposures giving greater depth of field.
 - c) **Yellow triangle:** For action shots such as sports photography (fast shutter speeds).
 The exact shutter speeds can be read underneath the shutter ring.
3. For flash photography the automatic mechanism is disconnected. The lens stops can now be set by hand (row of lens stops with flash and lamps symbol). The shutter speed ring should be set to the black field (1/30 sec.). For electronic flash all the other shutter speeds can be used on this setting.
4. For time exposures the lens stop ring is turned so that the B is in line with the mark. The shutter will then remain open as long as the release button is pressed down.

Built-in delayed action release

Agfa Selecta is the first camera of this kind to have a built-in delayed action release. For photographs of this kind too, the best exposure is set automatically: Set the delayed action lever to V, then press down release button. A buzzing noise then indicates that the mechanism is operating. After about ten seconds the shutter is released automatically. After the exposure press down the release button again firmly before transporting the film.

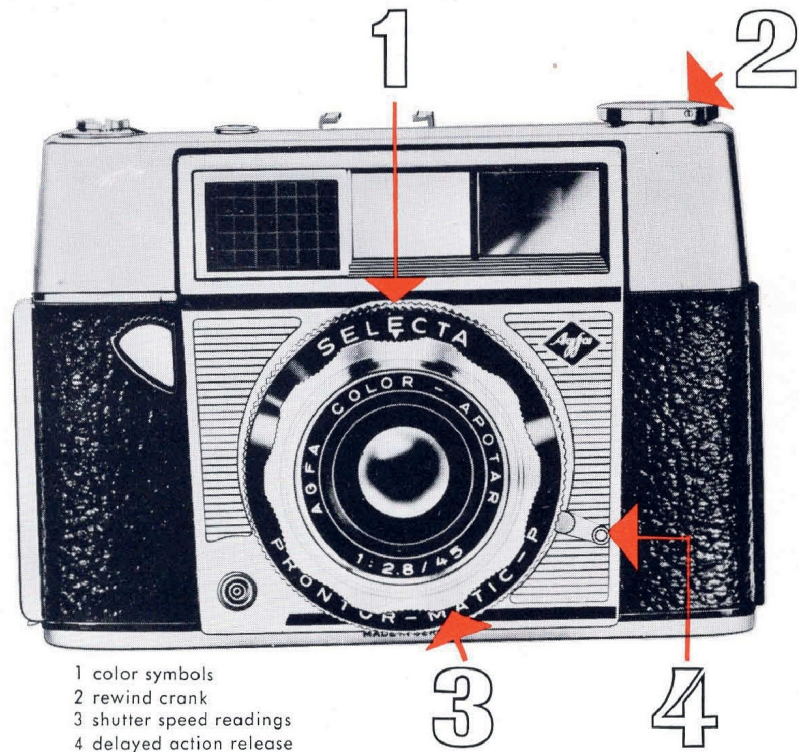

- 1 color symbols
- 2 rewind crank
- 3 shutter speed readings
- 4 delayed action release

AGFA SELECTA

A NEW PRODUCT

*The Camera with . . .
Selective Automation!*

Item	Product No.	List Price
SELECTA	(2204/263 64-97) (3+61-72)	\$99.95
Eveready Case	(6118/000 9-91) (3+ 9-42)	15.25

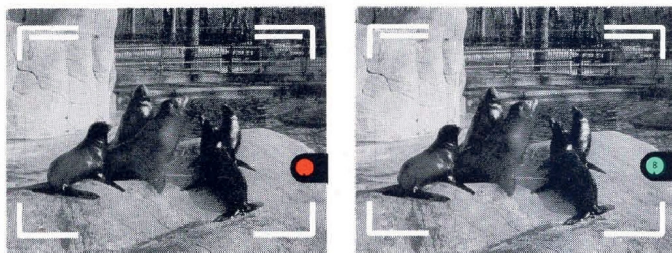

Modern rewind crank (the release button in the base of the camera remains recessed automatically—it springs out of its own accord when the film is subsequently transported).



WORLD FAMOUS AGFA CAMERAS



The most striking feature of this unusual high class camera is its motor-driven film transport. This high degree of technical convenience has created a special class of camera which is unique throughout the world.

The touch of a button sets off all the operations of the combined automatic exposure and transport mechanism.

1. The exact exposure is fixed automatically —at the same time the reliable visual signal appears in the viewfinder: "green" for "all clear."
2. The shutter is released.
3. The film is transported by the motor, at the same time the shutter is retensioned.
4. The camera is then ready for the next exposure.

Added to this are the selection possibilities offered by selective automation. The shutter speeds can be pre-selected—as with the Agfa Selecta. Here too, there are three clearly arranged color symbols (black, blue, yellow) for weather and lighting conditions. Readings of the exact shutter speeds are also possible.

Further technical refinements:

Coupled rangefinder with automatic parallax compensation of the bright-line frame down to 3¼ ft.

Four element Agfa Color-Solinar f.2.8/45 mm. lens.

Automatic mechanism disconnectible for flash and time exposures.

Rewind crank.

Built-in photoelectric exposure meter with exceptionally wide range.

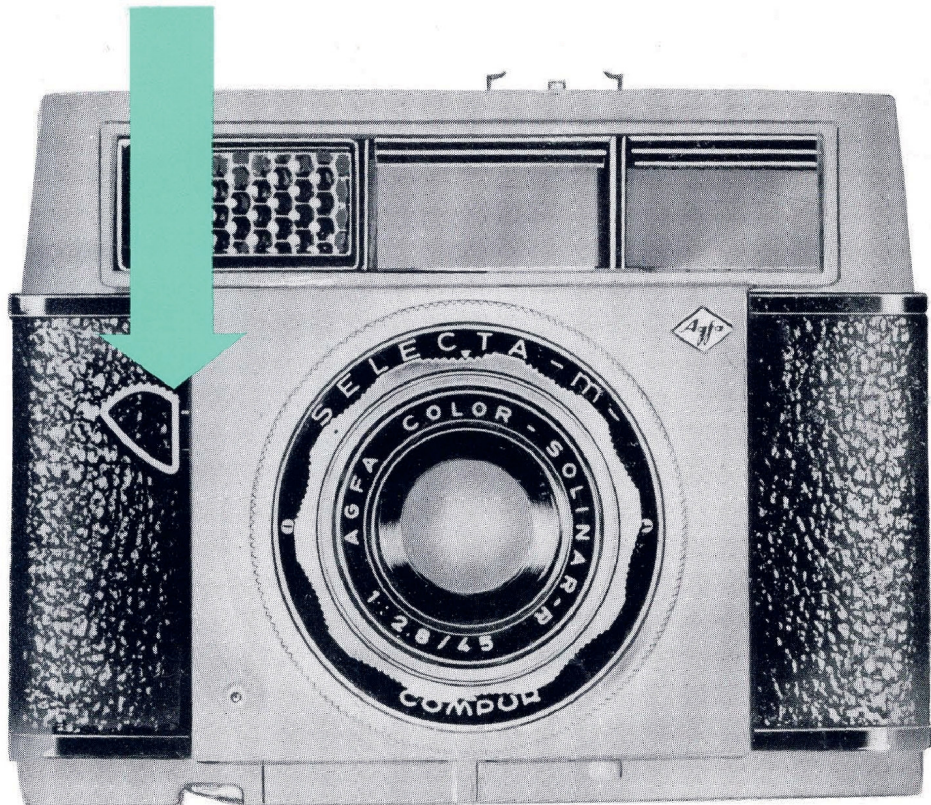

AGFA SELECTA-M

A NEW PRODUCT

UNIQUE THROUGHOUT THE WORLD

- MOTOR-DRIVEN FILM TRANSPORT
- SELECTIVE AUTOMATION

Item	Product No.	List Price
SELECTA M	(2220/249 128-70)	\$198.00
Eveready Case	(6115/000 10-73)	16.50

MOST STANDARD SCREW-IN FILTERS AND LENS SHADES OF 35.5mm FIT THE SELECTA M CAMERA

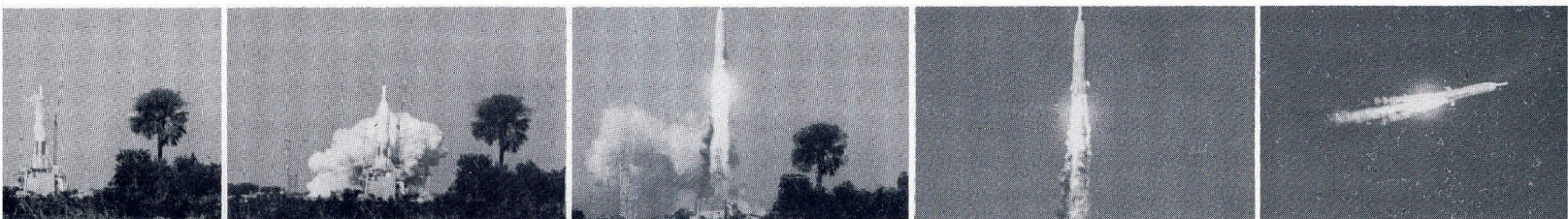

Motor-driven film transport and automatic exposure mechanism make a series of exposures possible in fast succession.

30 exposures per minute—with this outstanding camera.

New OPTIMA Ia

The perfect fully automatic

**Pre-Photokina
Scoop**



PERFECT TO BUY

\$59⁹⁵

PERFECT TO HOLD

The body is smaller, neater, lighter, made of a newly-developed high impact polystyrene material for strength without weight.

Only 5" x 2½" x 1¾"
18 ounces light.

PERFECT TO USE

Large, brilliant optical finder with silvered front element to reduce glare, give brighter image. Bright-line field for accurate framing.

Soft release virtually eliminates blur due to shutter vibration.

Conspicuous Red-Green Signal tells at a glance if light is good (Green for go) or inadequate (Red for stop.) If Red signal appears, use flash.

Click-Stop Symbol Focusing for near, medium and distance shots. For more exact focus, the footage scale is used.

IMPORTANT FEATURES

- **Fully automatic with specially designed stepless shutter** 1/30-1/160 sec. for continuously variable shutter speeds. It is programmed for optimum exposure, giving highest possible shutter speed to minimize camera shake.
- **High Exposure Indexes** ASA 10-250, adds hours to your photographic day, permitting the use of faster film.
- **Body Flash Contact** for more positive synchronization (X-type for bulbs and electronic flash.) No flash cords to worry about.
- **Crank Rewind** for faster, slip-free operation.

Item	Product No.	Price
Optima Ia	(2635/265 39-97) (3+37-97)	59.95
Case for Optima Ia	(6114/000 5-00) (3+4-75)	7.50
Agfa Tully Flash BODY contact	(6836/001 5-82) (10+4-83)	8.95
Agfa Isi-Flash BODY contact	(6830/001 3-87) (3+3-67) (12+3-21)	5.95

For Optima Ia use
Isi or Tully BODY
contact flashguns.

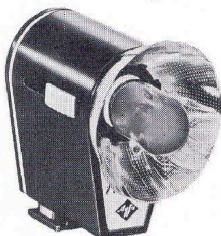

Agfa Tully Flash — BODY contact with leather case. Small and light, with retractable reflector. For all AG-type bulbs. Flash exposure calculator. Uses 15 volt battery.

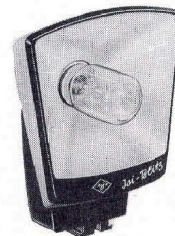

Agfa Isi-Flash BODY contact with case. For AG-type bulbs. Uses 15 volt battery.

WORLD FAMOUS AGFA CAMERAS



NEW OPTIMA I, OPTIMA IIS AND OPTIMA IIIS GIFT SETS



Now available: Optima I, Optima IIS and Optima IIIS Cameras tastefully gift-boxed. Supplied with protective sleeve.

Contents

OPTIMA I CAMERA

- Eveready Camera Case
- Tully Flashgun with case
- 1 Agfachrome CT 18 135-20
- Deluxe Gift Box

Contents

OPTIMA IIS CAMERA

- Eveready Camera Case
- Tully Flashgun with case
- 1 Agfachrome CT 18 135-20
- Deluxe Gift Box

Contents

OPTIMA IIIS CAMERA

- Eveready Camera Case
- Tully Flashgun with case
- 1 Agfachrome CT 18 135-20
- Deluxe Gift Box

Ideal for all gift-giving occasions: Graduation, Mother's Day, Father's Day, Weddings, Anniversaries, Birthdays, Christmas.

	Dealer Net	Value	Promotional List	Consumer Saves
Optima I Kit	(58-47) (3+55-54)	\$ 96.80	\$ 89.95	\$6.85
Optima IIS Kit	(77-97) (3+74-07)	128.10	119.95	9.15
Optima IIIS Kit	(97-47) (3+92-59)	177.15	149.95	27.20

NOTE: Don't forget the Battery and Flashbulbs.
For technical information on the above items see pages 6 and 14.



AGFA OPTIMA IIS

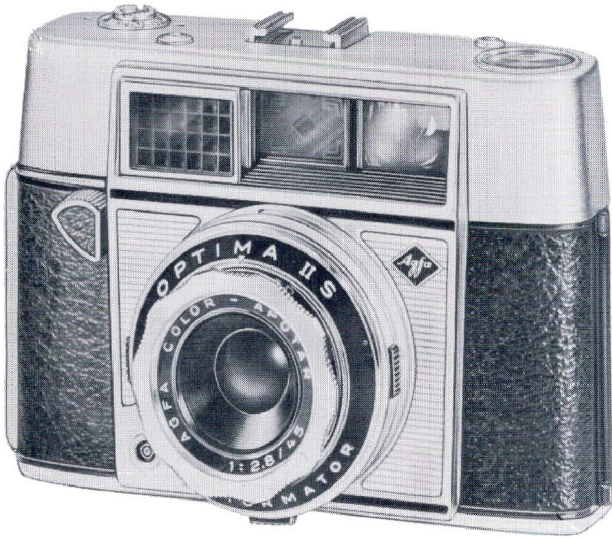

AGFA RESEARCH MARCHES ON!! Agfa pridefully presents the NEW and VERSATILE OPTIMA IIS, another TRUE, fully AUTOMATIC 35mm with many EXCLUSIVE INNOVATIONS. This OPTIMA features the exclusive Agfa PRONTORMATOR automatic shutter with STEPLESS settings from 1/30 to 1/250, matched to automatic lens apertures from F.2.8 to F.22. Rangefinder coupled to fast needle-sharp F.2.8 45mm lens with added provision for manually adjusted "X" synchronization automatic at 1/30th.

Like its predecessors the OPTIMA and the OPTIMA I, the IIS uses the "error-proof" Green-Red "traffic-light" exposure control system made famous by the original OPTIMA.

If you are interested in presenting REAL VALUE in a true fully automatic camera at an unbelievable price... this is the camera you should promote in your store!

Specifications:

- Agfa exclusive PRONTORMATOR STEPLESS shutter.
- Shutter sets itself AUTOMATICALLY from 1/30 to 1/250 sec with 9 light values.
- Agfa COLOR-APOTAR F.2.8 45mm lens, self setting to F.22.
- Coupled rangefinder of unusual clarity, centered within viewfinder window.
- GREEN-RED "traffic light" exposure control system with "MAGIC KEY" lever for both exposure setting and release.
- Single stroke shutter cocking and film advance.
- ASA film speed range from 10 to 250.

Item		List Price
AGFA OPTIMA IIS	(0429 66-67) (3+0429 59-97*)	\$99.95
EVEREADY CASE	(0924 7-90) (3+0924 7-11*)	11.85

*Can be assorted with 2 other cameras.

*Can be assorted with 2 other camera cases.

AGFA OPTIMA IIIS

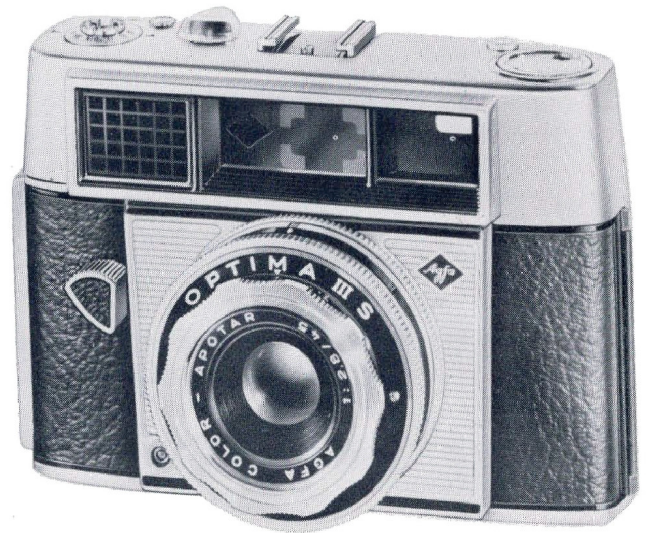

For the photographer who DEMANDS the FINEST and the most VERSATILE in a true, FULLY AUTOMATIC camera AGFA presents the OPTIMA IIIS. This camera is engineered for OPTIMUM EXPOSURE ACCURACY, designed for ACTION without worry; made for the photographer who can't afford to "miss a shot." THE BIG FEATURE of the OPTIMA IIIS is an entirely NEW INVENTION which permits UNINTERRUPTED EXPOSURE SCANNING, through the GREEN-RED signal which constantly is in operation to let the photographer know "if it is okay to shoot." Nothing to press, adjust or figure out! Both shutter and lens are fully automatic and operate STEPLESSLY through a full range from 1/30 to 1/500 sec with lens apertures from F.2.8 to F.22. Flash or Strobe synchronized through simple setting. You cannot offer your trade another camera that represents the VALUE found in the OPTIMA IIIS. There is no other camera more PRECISE or truly AUTOMATIC than the OPTIMA IIIS.

Specifications:

- EXCLUSIVE AGFA special COMPUR STEPLESS automatic shutter from 1/30 to 1/500 sec with 11 light values.
- UNINTERRUPTED EXPOSURE SCANNING through GREEN-RED constantly operating signal.
- ACCURATE EXPOSURE "LOCKS" through "Magic Key" lever.
- Needle-sharp F.2.8 45mm Agfa Color-Apotar lens coupled to rangefinder.
- Synchronized for Flash or Strobe.
- ASA film speed range from 10 to 250.
- Automatic Parallax correction.

Item		List Price
AGFA OPTIMA IIIS	(0431 83-00) (3+0431 74-70)	\$124.50
Eveready Case	(0924 7-90) (3+0924 7-11)	11.85

WORLD FAMOUS AGFA CAMERAS



OPTIMA I



This automatic 35mm camera to fit every budget. The right camera for everyday or vacation pictures. Beautiful style, with the magic key that sets the lens and releases the shutter.

Press button until you feel a slight resistance. When you see the green signal in the viewfinder—press down all the way...and you have your picture, black and white or color, perfectly exposed.

OPTIMA IIS



This precision camera is fully automatic... and has a coupled rangefinder, too.

A tremendous value, priced between the Optima I and IIS. When you press the magic key, the electric eye system sets both the lens opening and shutter speed, then releases the shutter. You enjoy photography without complicated calculations and guess work.

OPTIMA IIIS



The crowning achievement of the Agfa Optima line and the most versatile 35mm camera for the demanding fan—with a fully automatic range of exposures.

Full-time exposure scanning with green-red signal in constant operation. This signal also indicates whether shutter is cocked and film advanced.

The Optima IIIS is also equipped with a coupled, extra-brilliant precision rangefinder, plus automatic parallax correction.

- The camera covers a range of 7 light values when it shows the green signal. From morning to late afternoon you can take pictures automatically.
- For every kind of film, you set the film speed (ASA rating), and the camera sets the corresponding shutter time. With AgfaColor CN 17, for instance, the shutter time set by the camera is 1/250 sec. No blurred pictures. Even pictures of children at play will be sharp and crisp.
- If you want to take sports or other fast-action pictures, use a faster film.
- When the signal in the finder stays red, use flash. The Agfa-lux or KM flashguns are ideal for this purpose.
- Lens: The proven Agfa Color-Agnar f2.8.

Item	Product No.	List Price
OPTIMA I	12207-962-45-47 (3 + 43-19*)	\$59.95
Case	10110-000 9-07 (3 + 9-51**)	13.95

*Can be associated with 2 other cameras.

**Can be associated with 2 other camera cases.

- When the signal in the finder is green, the camera covers a range of 9 light values. You can take fully automatic pictures from early morning to late evening.
- The shutter automatically selects the fastest possible time (maximum speed 1/250 sec.) and then sets the lens opening. This is AGFA's exclusive Promptator shutter, which works steplessly with all kinds of film, black and white as well as color.
- Sleepless means that your picture can be taken at in-between settings—1,250 sec. and f9.3, for instance.
- No blurred pictures: sports action and fast moving objects are caught sharp and crisp.
- With red signal, use flash.
- The fast, world-famous Color-Apotar 12.8 lens gives you brilliant pictures.

Item	Product No.	List Price
AGFA OPTIMA IIS	12211-248 64-67 (3 + 61-72*)	\$99.95
Eveready Case	10112-000 9-91 (3 + 9-42**)	15.25

*Can be associated with 2 other cameras.

**Can be associated with 2 other camera cases.

- With the Optima IIIS, you have a range of 11 light values when the signal is green. This means fully automatic photography from dawn to dusk.
- AGFA's exclusive Comour-Special shutter adjusts itself for whatever film you use. Continuous stops from 1/30 to 1/500 sec., with lens stops from f2.8 to f22.
- Shutter times and lens openings are set steplessly and simultaneously the moment you press the magic key. Lens opening is set in fractions of 1/10 of an f-stop, and shutter speed in fractions of 1/100 of a second, to provide the best possible combination. It can take photos at f6.1 and 1/116 sec., for instance, without calculations and manual settings.
- An important feature of AGFA's exclusive Comour special sleepless shutter: speed increases to 1/500 sec. at twice the rate aperture decreases, for superior action-stopping ability.
- Fast-action photos are no problem, thanks to the advanced concept of the Optima IIIS.
- The famous quality of the fast Color-Apotar f2.8 lens complements the list of outstanding features of this top camera.

Item	Product No.	List Price
AGFA OPTIMA IIIS	12202-251 50-01 (3 + 82-81*)	\$149.00
Eveready Case	10112-000 9-49 (3 + 9-49**)	15.25

*Can be associated with 2 other cameras.

**Can be associated with 2 other camera cases.

Green signal - OK to shoot



Green signal - OK to shoot



Green signal - OK to shoot



AGFA OPTIMA REFLEX



OPTIMA = *full* automation for ease of picture **taking**

REFLEX = *brilliant* viewing for ease of picture **composition**

For the Sophisticate who wants the very best.

The first fully automatic 35mm reflex camera in the world combines the full automation of the Optima line with the brilliant viewfinding properties of a reflex camera.

- ▲ green-red traffic signals for exposure controls—of different shape to be identified by color-blind people
- ▲ precision ground penta prism for crystal clear viewing
- ▲ split-image rangefinder at 45 degree angle permits focusing on both vertical and horizontal lines
- ▲ two fast Agfa Color-Apotar f/2.8 lenses of identical precision manufacture perfectly matched to equal focal length
- ▲ patented Agfa automatic shutter
- ▲ shutter speeds ranging from 1/30 secs at f/2.8 to 1/250 secs at f/8 to f/22. From f/2.8 to f/8, shutter speed automatically increases at twice the rate as lens closes
- ▲ parallax practically non-existent—.025 inch at 3.3 feet
- ▲ no mirror noise—no time lag between activating of release and actual picture taking
- ▲ rapid rewind with convenient pop-up handle
- ▲ single stroke rapid shutter cocking and film advance operated with thumb of left hand while right hand can remain on exposure lever

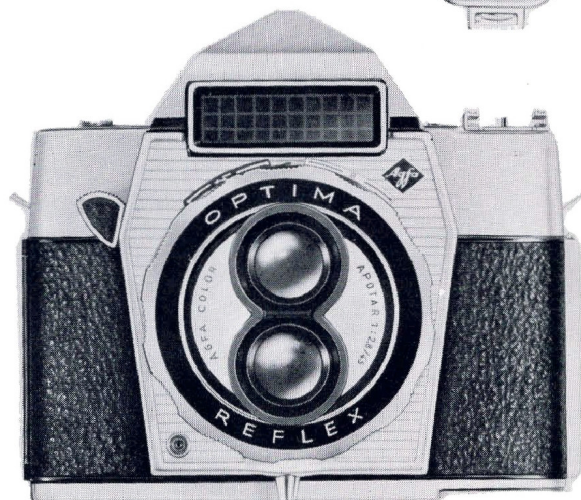
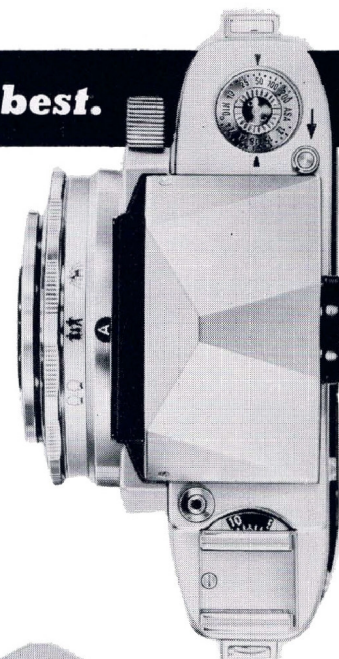

10 LIGHT VALUES

Item	Product No.	List Price
AGFA OPTIMA REFLEX Eveready case	(3000/272 109-85) (3+104-36*) (6116/000 10-73) (3+ 10-19**)	\$169.00 16.50
Yellow medium filter, combined with sun shade	(6345/051 3-30)	4.95
UV Filter, combined with sun shade	(6346/051 3-30)	4.95
R 1, 5 combined with sun shade	(6347/051 3-30)	4.95
Close-up lens	(6348/051 4-20)	6.30
Lens-hood	(6349/051 1-20)	1.95
Leather case for one filter or lens-hood	(6165/000 1-90)	2.85
Leather case for 2 filters	(6166/000 2-20)	3.30

AGFAFLEX I

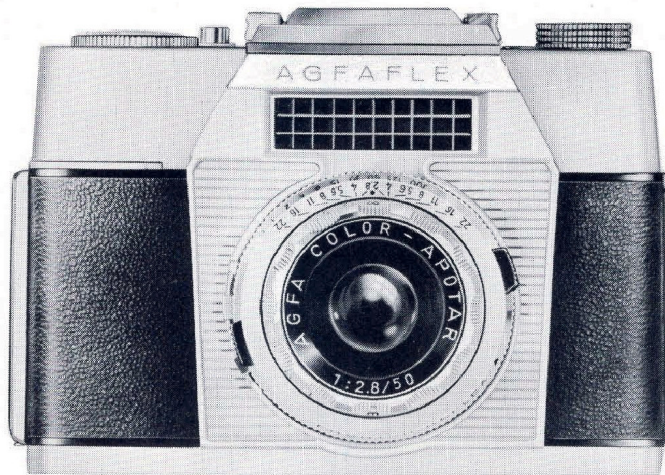

35mm single-lens reflex camera with waist-level viewfinder, built-in exposure meter, simultaneous split-image and ground glass focusing, pre-set automatic Prontor-Reflex shutter B to 1/300 sec., 50mm f/2.8 Agfa Color-Apotar lens, MX synchronization, self-timer, single-stroke rapid film advance. Waist-level finder is interchangeable with eye-level prism finder.

Item		List Price
Agfaflex I	(0410 66-63) (3+0410 59-97*)	\$99.95
Eveready Case	(0915 6-67) (3+0915 6-00**)	10.00
Eyelevel Prismfinder	(1405 25-00)	37.50
Close-up lens 16"-28"	(1009 2-50) (3+1009 2-25)	3.75

*Can be assorted with two other cameras.
**Can be assorted with two other camera cases.

AGFAFLEX II



35mm single-lens reflex camera with interchangeable eye-level prism-finder and waist-level finder,* built-in exposure meter, simultaneous split-image, and ground glass focusing, pre-set automatic Prontor-Reflex shutter B to 1/300 sec., 50mm f/2.8 Agfa Color-Apotar lens, MX synchronization, self-timer, single-stroke rapid film advance.

*Optional—\$7.50 extra.

Item		List Price
Agfaflex II	(0411 86-63) (3+0411 77-97*)	\$129.95
Eveready Case	(0915 6-67) (3+0915 6-00**)	10.00
Close-up lens 16"-28"	(1009 2-50) (3+1009 2-25)	3.75

*Can be assorted with two other cameras.
**Can be assorted with two other camera cases.

WORLD FAMOUS AGFA CAMERAS



TWO extremely versatile Agfa single lens 35mm classics in quality, precision and design.

Featuring brilliant interchangeable waist level and eye level prism finders and an interchangeable lens system with 35, 55, 90 and 135mm focal length lenses available.

These are the cameras to show your professional and top amateur trade—these are the cameras you can sell with complete pride.

AGFAFLEX IV, V with lens and finder interchangeability

AGFAFLEX IV

Item	Product No.	List Price
Brilliant eye-level prism finder, f/2.8 50mm Agfa Color-Solinar in Prontor reflex shutter B-1/300 sec., featuring automatic pre-set diaphragm. Coupled exposure meter with needle on top of camera, simultaneous split-image, and ground glass focusing, MX synchronization, self-timer	(3105/942 103-35) (3+98-18*)	\$159.00
Matching Eveready leather case	(6012/000 10-40) (3+ 9-88**)	16.00
Agfaflex IV, body only	(3105/000 68-67)	103.00
Agfaflex IV, body only without prism finder	(3100/001 45-67)	68.50

AGFAFLEX V

Item	Product No.	List Price
Same as IV but with Agfa Color-Solagon f/2. 55mm	(3106/942 128-70) (3+122-27*)	\$198.00
Matching Eveready leather case	(6012/000 10-40) (3+ 9-88**)	16.00

*Can be assorted with 2 other cameras.
**Can be assorted with 2 other camera cases.

LENSES

Item	Product No.	List Price
Agfa Color-Ambion f/3.4 35mm	(4412/320 46-00)	\$ 69.00
Agfa Color Telinear f/3.4 90mm	(4413/320 52-00)	78.00
Agfa Color Telinear f/4 135mm	(4414/020 59-33)	89.00
Agfa Color-Solagon f/2 55mm	(4416/020 70-00)	105.00

ACCESSORIES

Item	Product No.	List Price
Eye-level prism finder	(3041/020 25-00)	\$37.50
Waist-level finder	(3042/020 5-00)	7.50
Close-up lens I (22" to 36")	(6712/460 3-33)	5.00
Close-up lens II (15" to 22")	(6711/460 3-33)	5.00
Leather Case for either 35, 50, 55 and 90mm Agfaflex lenses	(6151/000 2-63)	3.95
Leather Case for 135mm Agfaflex lens	(6152/000 3-00)	4.50
Agfa Flash Bracket	(6790/000 0-67)	1.00
Agfa Neck Strap	(6013/000 1-00)	1.50

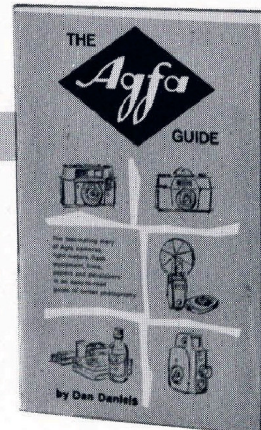
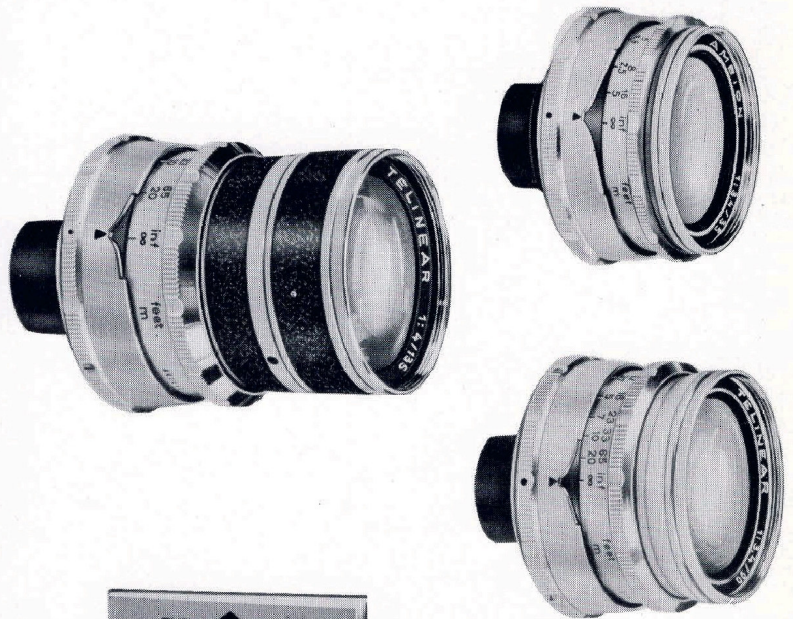
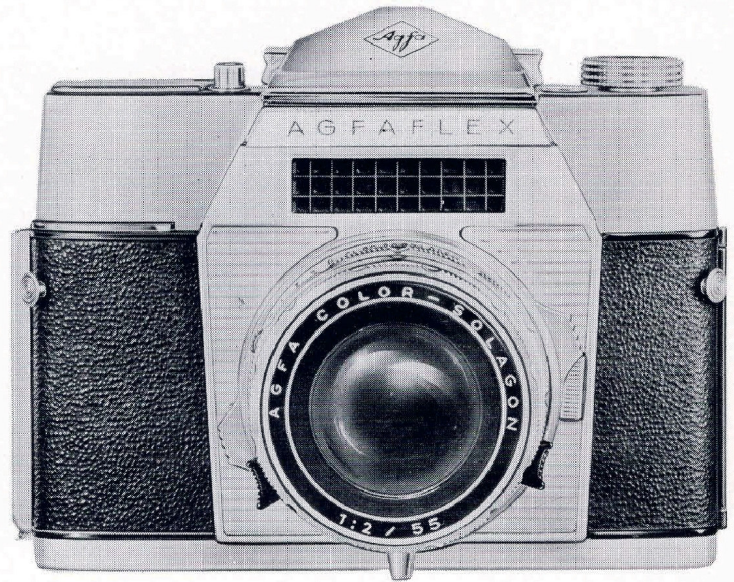

AGFA GUIDE

Booklet, covering all Agfa cameras, light meter, flash equipment, films, papers and developers in an easy-to-read guide to better photography.

(990000/101) (3+1-17) (6+0-98)

List Price \$1.95

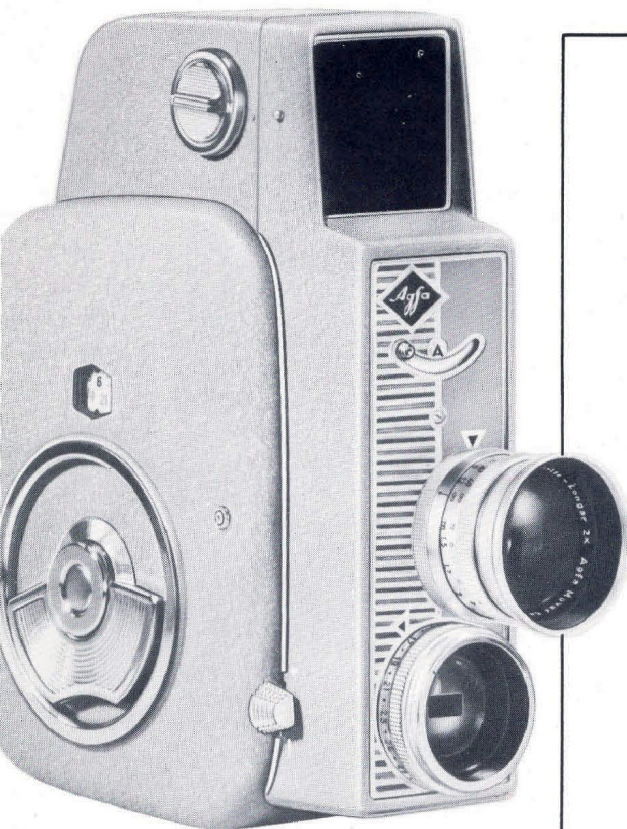

AGFA MOVEX AUTOMATIC

Fully automatic "electric eye" 8mm double eight motion picture camera for film speeds from 10 ASA to 400 ASA, 25 foot double eight film capacity, spool load, brilliantly sharp 5 element Agfa Movestar lens f/1.9 focuses from 7½ inches to infinity, life-size viewfinder with automatic parallax correction down to 3 feet. Telephoto and wide-angle lens attachments available.

Item		List Price
AGFA MOVEX AUTOMATIC	(0502 66-63) (3+0502 59-97*)	\$99.95
EVEREADY CASE for Movex Automatic	(0961 10-00) (3+0961 9-00*)	15.00
TELELONGAR 24mm telephoto lens, screw-in	(1453 26-00) (2+1453 23-40*)	39.00
CURTAR 6mm wide-angle lens, screw-in	(1452 26-00) (2+1452 23-40*)	39.00

*Movex Automatic can be assorted with 2 still cameras:
lenses can be assorted with lenses of still cameras.

FILTERS AND LENS SHADE FOR AGFA MOVEX 88L AND MOVEX AUTOMATIC

Item		List Price
Yellow filter (-1)	(1454 2-63) (3+1454 2-37*)	\$3.95
Gray filter (-2)	(1455 2-63) (3+1455 2-37*)	3.95
Gray filter (-4)	(1456 2-63) (3+1456 2-37*)	3.95
U.V. filter	(1457 2-63) (3+1457 2-37*)	3.95
R 1.5 skylight filter	(1458 2-63) (3+1458 2-37*)	3.95
Sunshade in leather case	(1459 2-17) (3+1459 1-95*)	3.25

*Can be assorted.

FILTERS

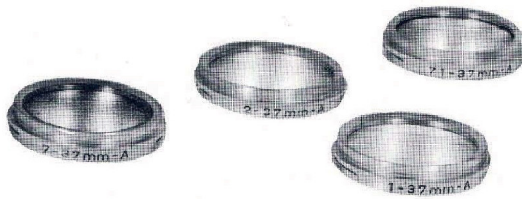

Type			List Price
30mm slip-on	light yellow	(1030 2-33) (3+1030 2-10*)	\$3.50
For Agfa Silette Vario	medium yellow	(1031 2-33) (3+1031 2-10*)	3.50
Agfa Silette Mirro-Magic	yellow green	(1032 2-33) (3+1032 2-10*)	3.50
Agfa Super Silette L	red orange	(1033 2-33) (3+1033 2-10*)	3.50
Agfa Solina	U.V.	(1034 2-33) (3+1034 2-10*)	3.50
Agfa Solinette	R 1.5 (Skylight)	(1035 2-33) (3+1035 2-10*)	3.50
32mm slip-on	light yellow	(1040 2-33) (3+1040 2-10*)	3.50
For Agfa Automatic 66	medium yellow	(1041 2-33) (3+1041 2-10*)	3.50
Agfa Karat IV	yellow green	(1042 2-33) (3+1042 2-10*)	3.50
	red orange	(1043 2-33) (3+1043 2-10*)	3.50
	U.V.	(1044 2-33) (3+1044 2-10*)	3.50
	R 1.5 (Skylight)	(1045 2-33) (3+1045 2-10*)	3.50
35.5mm screw-in	light yellow	(1060 2-33) (3+1060 2-10*)	3.50
For Agfa Optima	medium yellow	(1061 2-33) (3+1061 2-10*)	3.50
Agfa Ambi Silette	yellow green	(1062 2-33) (3+1062 2-10*)	3.50
Agfa Super Silette Automatic	red orange	(1063 2-33) (3+1063 2-10*)	3.50
Agfa Super Silette LK	U.V.	(1064 2-33) (3+1064 2-10*)	3.50
Agfa Silette LK	R 1.5 (Skylight)	(1065 2-33) (3+1065 2-10*)	3.50
Agfa Silette SL	KB 12 (80B)**	(9823 2-33) (3+9823 2-10*)	3.50
Agfa Silette Automatic	KB 3 (82A)**	(9826 2-33) (3+9826 2-10*)	3.50
Agfaflex I and II	KB 6 (82C)**	(9824 2-33) (3+9824 2-10*)	3.50
Agfa Super Solina	KR 12 (85)**	(9820 2-33) (3+9820 2-10*)	3.50
Curtar and Telelongar lenses of Agfa Movex 88L and Agfa Movex Automatic	KR 15 (85C)**	(9827 2-33) (3+9827 2-10*)	3.50
37mm slip-on	light yellow	(1050 2-33) (3+1050 2-10*)	3.50
For Agfaflex I and II	medium yellow	(1051 2-33) (3+1051 2-10*)	3.50
Agfa Super Silette Automatic	yellow green	(1052 2-33) (3+1052 2-10*)	3.50
Agfa Super Silette LK	red orange	(1053 2-33) (3+1053 2-10*)	3.50
Agfa Silette LK	U.V.	(1054 2-33) (3+1054 2-10*)	3.50
Agfa Silette SL	R 1.5 (Skylight)	(1055 2-33) (3+1055 2-10*)	3.50
Agfa Silette Automatic			
Agfa Super Solina			
Agfa Ambi Silette			
Curtar and Telelongar lenses of Agfa Movex 88L and Agfa Movex Automatic			
46mm screw-in	light yellow	(1070 2-83) (3+1070 2-55*)	4.25
For Agfaflex IV and V	medium yellow	(1071 2-83) (3+1071 2-55*)	4.25
	yellow green	(1072 2-83) (3+1072 2-55*)	4.25
	red orange	(1073 2-83) (3+1073 2-55*)	4.25
	U.V.	(1074 2-83) (3+1074 2-55*)	4.25
	R 1.5 (Skylight)	(1075 2-83) (3+1075 2-55*)	4.25
	KB 3 (82A)**	(9831 2-83) (3+9831 2-55*)	4.25
	KB 6 (82C)**	(9832 2-83) (3+9832 2-55*)	4.25
	KR 12 (85)**	(9833 2-83) (3+9833 2-55*)	4.25
	KR 15 (85C)**	(9834 2-83) (3+9834 2-55*)	4.25
51mm slip-on combined with lens shade	medium yellow	(1461 2-33) (3+1461 2-10*)	3.50
For Agfa Reflex	U.V.	(1464 2-33) (3+1464 2-10*)	3.50
	R 1.5 (Skylight)	(1465 2-33) (3+1465 2-10*)	3.50
62mm screw-in			
For 130mm Agfa Color Telinear	KR 1.5 (Skylight)	(9821 5-67) (3+9821 5-10*)	8.50
	U.V.	(9822 5-67) (3+9822 5-10*)	8.50

*Lens shades and filters can be assorted for maximum discount.

**The listed light balancing filters are manufactured by Biermann & Weber, Wiesbaden, Germany. The filter numbers are based on the decamired system.

AGFA ACCESSORIES



FILTERS



LENS SHADE

in leather case and space for 2 filters

Item	List Price	List Price
32mm slip-on For Agfa Automatic 66 Agfa Karat IV Silette I Silette L	light yellow (6330/320 2-33) \$3.50 medium yellow (6331/320 2-33) 3.50 yellow green (6332/320 2-33) 3.50 red orange (6333/320 2-33) 3.50 U.V. (6334/320 2-33) 3.50 R 1.5 (Skylight) (6335/320 2-33) 3.50	(6304/000 2-50) \$3.75
35.5mm screw-in For Agfa Optima 2200, I, IIS, IIIS, Selecta, Selecta-m Agfa Ambi Silette Agfa Super Silette Automatic Agfa Super Silette LK Agfa Silette LK Agfa Silette SL Agfa Silette Automatic Agfaflex I and II Agfa Super Solina Curtar and Telelongar lenses of Agfa Movex 88L and Agfa Movex Automatic	light yellow (6330/355 2-33) 3.50 medium yellow (6331/355 2-33) 3.50 yellow green (6332/355 2-33) 3.50 red orange (6333/355 2-33) 3.50 U.V. (6334/355 2-33) 3.50 R 1.5 (Skylight) (6335/355 2-33) 3.50	(6319/000 2-50) 3.75
37mm slip-on For Agfaflex I and II Agfa Super Silette Automatic Agfa Super Silette LK Agfa Silette LK Agfa Silette SL Agfa Silette Automatic Agfa Super Solina Agfa Ambi Silette Curtar and Telelongar lenses of Agfa Movex 88L and Agfa Movex Automatic	light yellow (6330/370 2-33) 3.50 medium yellow (6331/370 2-33) 3.50 yellow green (6332/370 2-33) 3.50 red orange (6333/370 2-33) 3.50 U.V. (6334/370 2-33) 3.50 R 1.5 (Skylight) (6335/370 2-33) 3.50	(6306/000 2-50) 3.75
37mm slip-on For Agfa Ambi Silette with 35, 50 and 90mm lenses		(6308/000 2-50) 3.75
46mm screw-in For Agfaflex IV and V	light yellow (6330/460 2-83) 4.25 medium yellow (6331/460 2-83) 4.25 yellow green (6332/460 2-83) 4.25 red orange (6333/460 2-83) 4.25 U.V. (6334/460 2-83) 4.25 R 1.5 (Skylight) (6335/460 2-83) 4.25	(000/177 3-00) 4.50
51mm slip-on combined with lens shade For Optima Reflex and Agfa Reflex	medium yellow (6345/051 3-30) 4.95 U.V. (6346/051 3-30) 4.95 R 1.5 (Skylight) (6347/051 3-30) 4.95	(6349/051 1-20) 1.95*
62mm screw-in For 130mm Agfa Color Telinear	KR 1.5 (Skylight) (000/101 5-67) 8.50 U.V. (000/102 5-67) 8.50	(000/175 4-17) 6.25
Leather case for one filter or lens-hood (51mm)	(6165/000 1-90) 2.85	
Leather case for 2 filters (51mm)	(6166/000 2-20) 3.30	

*without leather case

Filter	Effect	Filter Factor
Light yellow	Blue reproduced darker; yellow, green, red are slightly brightened.	1.5
Medium yellow	Blue considerably darker, yellow, green, red, considerably lighter.	2
Yellow-green	Blue and red will appear a little darker; yellow and particularly green will be rendered in their true tone values.	2.5
Red-orange	Atmosphere haze will be reduced. Dramatic effects of heavy clouds against dark sky.	4
Ultra Violet	Use with black and white or Agfacolor CN 17 film to cut through haze.	1.5
R 1.5 (Skylight)	Use with Agfachrome CT 18 to prevent bluish cast when making pictures at the beach, from the air, mountain photography, etc.	1

Agfa filters are used to produce correct tone values of a scene on black and white film or to produce certain dramatic effects by changing and exaggerating tone values. Made of plane-parallel optical glass dyed in the mass, Agfa filters will not interfere with the excellent performance of your Agfa lens. Because filters block some light, an increase in exposure (the filter factor) is required. These filter factors are listed next to the filter. A factor of 2 (meaning 2X normal exposure) means increase exposure one full lens stop (e.g., f/11 to f/8, etc.) or change the shutter speed (from 1/100 to 1/50, etc.).

CLOSE-UP LENSES

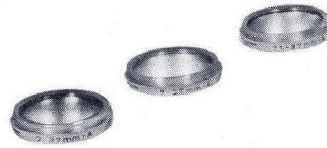

Type	Range	List Price
35.5mm screw-in For Agfa Optima	30" to 50" (1014 2-50) (3+1014 2-25*)	\$3.75
51mm slip-on combined with lens shade For Agfa Reflex	15" to 31" (1015 3-17) (3+1015 2-85*)	4.75
35.5mm screw-in For Agfaflex I and II	16" to 28" (1009 2-50) (3+1009 2-25*)	3.75
46mm screw-in For Agfaflex IV and V		
Close-up lens No. I	22" to 35" (1012 3-33) (3+1012 3-00*)	5.00
Close-up lens No. II	15" to 22" (1013 3-33) (3+1013 3-00*)	5.00

CLOSE-UP ATTACHMENTS

Type	Range	List Price
Proximeter I	29" to 40" (1005 16-70) (3+1005 15-00*)	\$25.00
Proximeter II	13" to 20" (1006 16-70) (3+1006 15-00*)	25.00
For Agfa Ambi Silette		
30mm Agfa Natarix slip-on close-up lens with viewfinder	16" to 28" (1010 4-63) (3+1010 4-17*)	6.95
For Agfa Silette Vario Agfa Solina Agfa Solinette Agfa Silette Mirro-Magic		
35.5mm Agfa Natarix screw-in close-up lens with viewfinder	16" to 28" (1011 5-00) (3+1011 4-50*)	7.50
For Agfa Super Silette Automatic Agfa Super Silette LK Agfa Super Solina Agfa Silette Automatic Agfa Silette LK		

*Close-up lenses and attachments can be assorted for maximum discount.

AGFA EXPOSURE METERS



AGFA LUCIMETER S

Extremely lightweight, beautifully moulded to fit the hand, extremely easy to read and understand—even for the novice. The specifications below list other features which make this exposure meter an outstanding value.

Specifications:

Photo-electric coincidence-type meter with automatic temperature compensating device, double shock proofing, incident light attachment, shutter speed and diaphragm scales plus LVS scale, movie shutter speed marker, 10 to 1600 ASA, modern-style ivory and grey plastic housing. Comes in transparent plastic case.

Product Number	List Price
(6380/000 12-97) (4+10-77*)	\$19.95
ZIP CASE for Lucimeter S (6079/000 1-00)	1.50

AGFA LUCIMAT



At the touch of a "magic" button, the new ivory-gray AGFA Lucimat light meter automatically registers the light value and the corresponding combinations of exposure time and lens openings. Climatic changes do not affect operation. Scale for exposure speeds ranges from 1/1000 to 8 seconds; aperture scale from f/1.4 to f/32. ASA values range from 10 to 2000. The meter also has a movie shutter speed marker.

Product No.	List Price
(6381/000 19-47) (4+16-17*)	\$29.95
CASE for Lucimat (6081/000 2-00)	3.00

*Lucimat, Lucimeter S exposure meters can be assorted.

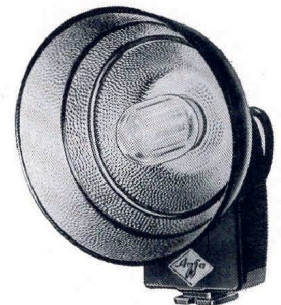
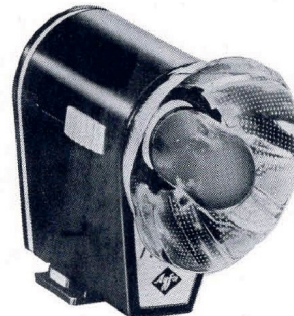
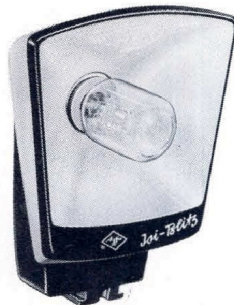
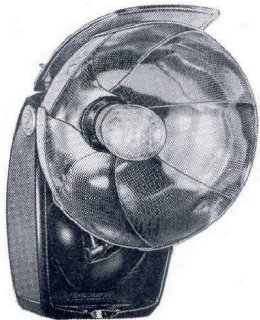

AGFA FLASH ATTACHMENTS

Item	Product Number	List Price
AGFALUX M , folding-type pocket flash unit, BC 22½ Volts (w/o battery) for M-type bulbs without case	(6875/000 5-82) (10+4-83**)	\$8.95
AGFALUX M with case	(6875/001 6-47) (10+5-37*)	9.95
Case for Agfalux *Agfalux with case and without case can be assorted.	(6076/000 1-00)	1.50
AGFA TULLY K-FLASH with leather case. Small and light, with retractable reflector. For all AG-type bulbs. Flash exposure calculator. Uses 15 Volt battery.	(6836/001 5-82) (10+4-83**)	8.95
AGFA ISI-FLASH with case. For cameras with accessory shoe flash contact. For AG-type bulbs. Uses 15 Volt battery.	(6830/001 3-87) (3+3-67) (12+3-21)	5.95
AGFA KM POCKET FLASH with case. BC flashgun for M-type bulbs, lightweight shock resistant plastic. Reflector reverses for compactness when carried in pocket or purse. Fits all standard camera accessory clips.	(6829/001 3-97) (6+3-57) (12+2-97)	5.95
AGFA FLASH BRACKET **Tully K-Flash and Agfalux can be assorted for quantity discount.	(6790/000 0-67)	1.00

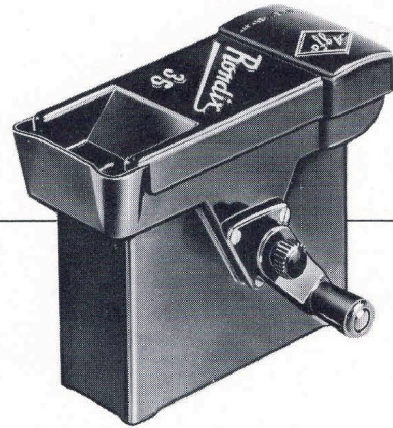
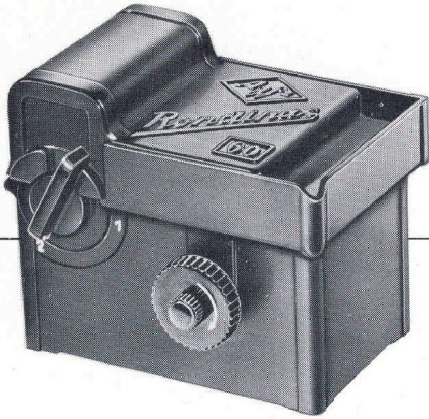

AGFA DEVELOPING TANKS

Item	List Price
AGFA RONDIX 35 , developing tank for all 35mm magazines, daylight loading, corrosion and shock proof, achieving completely uniform development, no reels. (1085 6-00) (3+1085 5-40*)	\$ 8.95
AGFA RONDINAX 60 , daylight loading developing tank for 120 size films, corrosion and shock proof, economical: holds 5 oz., uniform development. (1086 7-30) (3+1086 6-57*)	10.95

*Rondix 35 and Rondinax 60 can be assorted.



AGFA 35mm SLIDE MOUNTS Type W/Box of 20

Item	List Price
Exclusive plastic frame with hinged door permits easy installation of pre-cleaned glass plates and color slide. Locks tight without special binding. (1540 1-24) (3+1540 1-11) (12+1540 0-93)	\$1.85

AGFACOLOR NEGATIVE WALLETS

Ideal storage wallet for color or black and white films. Made of clear cellophane, hardpaper cover, very compact for filing.

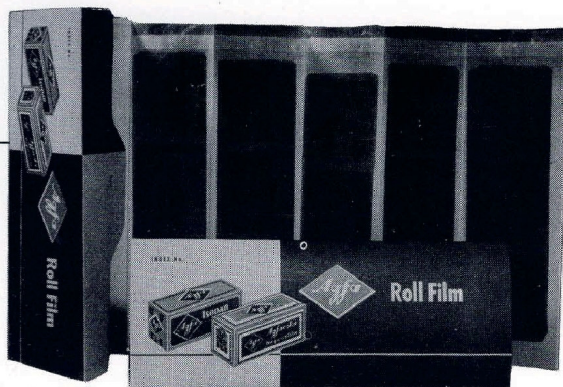

Item	List Price
For 35mm Negative, package of 100 (1531 5-00) (5000+1531 4-50) (50000+1531 4-00)	\$10.00
For 120, 620, 127 Roll Film, package of 100 (1530 5-00) (5000+1530 4-50) (50000+1530 4-00)	10.00

AGFA STILL PROJECTOR

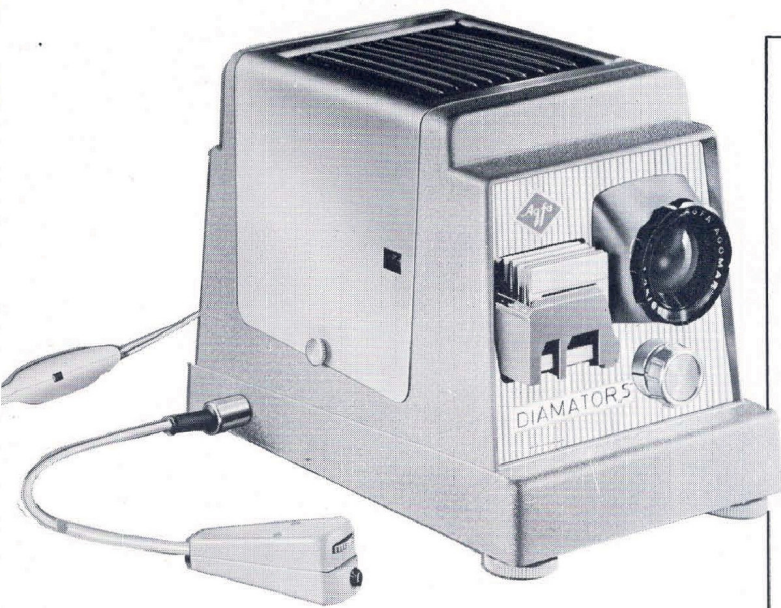

AGFA DIAMATOR S

Every so often a customer is looking for the unusual in an automatic remote-controlled projector for 2x2" slides. AGFA's newest contribution to the still projector field is the Diamator S. This automatic projector features a dual purpose remote control two button cable permitting slide changing by the press of one button and at the same time accurate remote control focusing of the helical geared projector lens with the other. The 30 slide magazine accepts either cardboard or glass mounted slides intermixed as required. It also features as an accessory the AGFA Diamaton which permits the user to hook up the Diamator S with any standard tape recorder for commentary or background music and either can be recorded so that it is accurately synchronized with the automatic slide changing mechanism of the AGFA Diamator S. This is extremely important for the educator, for selling demonstration or the typical travelogue.

This is the still projector to show your tape recorder customers. This is the projector to show hi-fi hobbyists who are also camera fans. The Diamator S together with the Diamaton makes every slide show an entertaining and unforgettable experience.

Features include:

- Clean modern compact design.
- Brilliant 300 watt illumination.
- A double condenser system that assures an unusually even and brilliant distribution of light, equalling that of most higher watt units.
- Extremely quiet blower cooling mechanism.
- Tilting screws with vertical adjustment.
- Convenient setting knob for manual operation and the disconnecting of the automatic transport.

Item	List Price
DIAMATOR S with 3 inch lens (0706 77-97)	\$129.95
DIAMATOR S with 4 inch lens (0706 77-97)	129.95
DIAMATOR S with 6 inch lens (0708 80-97)	134.95
CASE (0983 7-50)	12.50
MAGAZINES, set of five (1512 4-17)	6.95
DIAMATON (1513 17-40)	29.00
CONTACT FOIL (1514 0-65)	1.00
6" AGOMAR F/2.8 (1515 22-50)	37.50

AGFA DIAMATOR S with wireless slide advance control.

DIAMATOR S with 3 inch lens (0707 77-95)	\$129.95
DIAMATOR S with 4 inch lens (0707 77-97)	129.95
DIAMATOR S with 6 inch lens (0707 80-97)	134.95

Accessories as above

AGFA 35mm SLIDE MOUNTS Type W/Box of 20

Exclusive plastic frame with hinged door permits easy installation of pre-cleaned glass plates and color slide. Locks tight without special binding.

List Price
(1540 1-24) (3 + 1540 1-11) (12 + 1540 0-93)
\$1.85

Fig. A - Wiring diagram for Diamaton

Fig. B - Tape contact

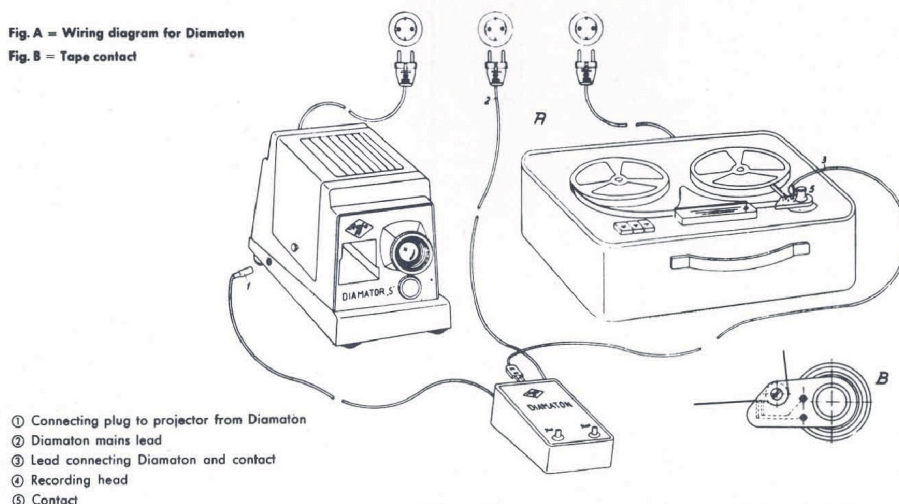

AGFA 8mm SOUND PROJECTOR

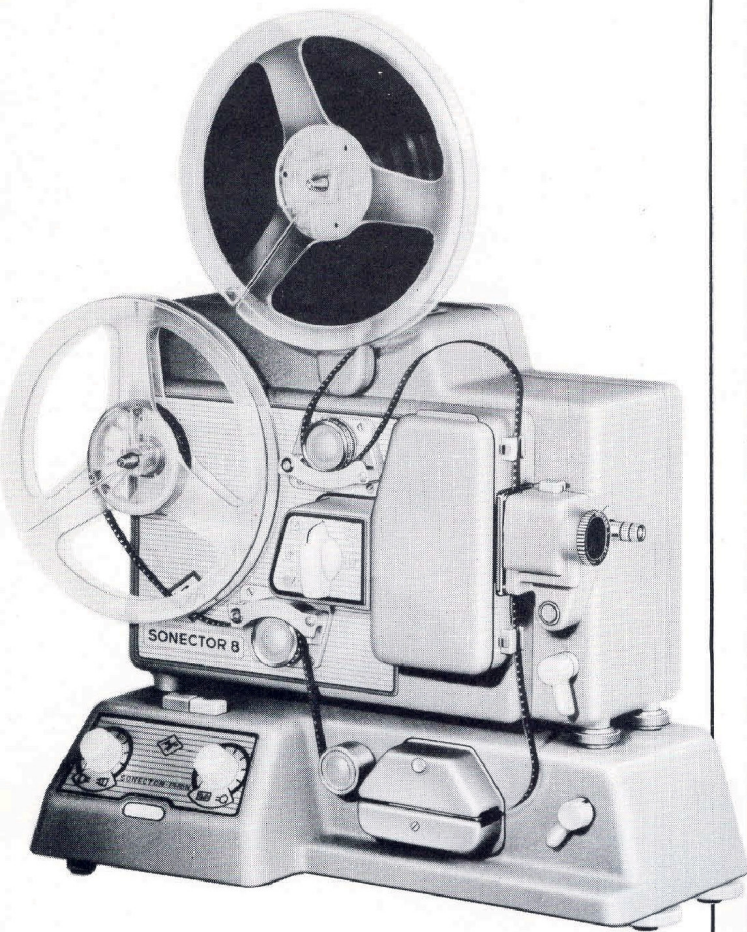

AGFA SONECTOR 8

8mm sound projector with microphone and speaker, 20mm (3/4 inch) f/1.4 Agfa Movenar projection lens, 8 Volt 50 Watt projection lamp with built-in reflector.

Technical Data:

Sound recording is done straight or intermixed on 8mm sound-striped film through microphone, radio, record player or tape recorder. 400 foot reels.

Projection speed 18 f.p.s.

Number of frames between film gate and sound head 56.

Hi-fi 8 inch speaker and amplifier built into carrying case.

Low-voltage 50 Watt long life projection lamp with 500 Watt output.

Frequency approx. 80 to 7000 c.p.s.

Forward and reverse drive with and without projection.

Power rewind.

Interval light connection automatically switches on interval lamp when projector lamp is switched off.

Sockets to connect radio, hi-fi system, ear-phones.

Item	List Price
AGFA SONECTOR 8, with case	(0603 259-35) \$389.00

Synchro Vox for Sonecator 8 Sound Projector. Makes possible accurate synchronization of tape recorder with Sonecator film projection. Available by special order. Delivery 2 months.

SYNCHRO VOX	(9982 32-81) \$43.75
--------------------	-----------------------------

Sonecator projection lamp; 50 watt with built in reflector.

PROJECTION LAMP	(0002 4-17) 6.95
------------------------	-------------------------

Electric cable and special plug with connection for Sonecator 8 to either hook up to tape recorder or connect with table lamp.

ELECTRIC CABLE	(1521 1-00) \$1.50
-----------------------	---------------------------

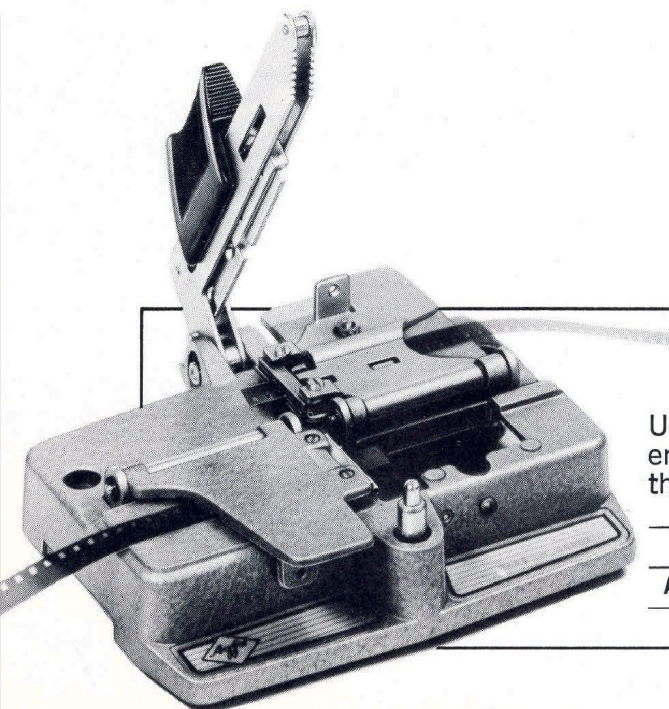

AGFA 8mm FILM SPLICER

Unique design permits easy scraping off of the two film ends resulting in a greatly reduced "click" sound of the spliced parts.

Item	List Price
AGFA FILM SPLICER	(1551 9-97) (3+1551 8-97) \$14.95



In addition to the modern styling of the Agfa Varioscop 35/44 this enlarger incorporates well designed controls which make it simple and economical to operate.

NEW FEATURES:

Conveniently placed lever for setting enlargement scale. The lever always returns to starting position.

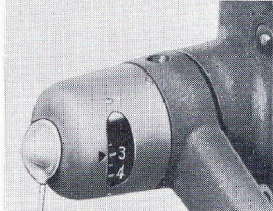

Quickly fitted negative carrier permitting easy insertion of film; automatic or manual focusing operation. Unique film transport can be operated by knob at baseboard.

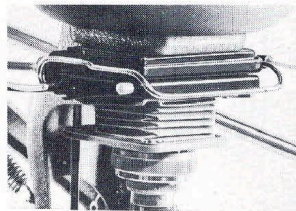

OPTICAL EQUIPMENT:

The Solagon D II f 4.5/60 mm lens, six elements (rare earth glass used), provides maximum illumination right to the edges of miniature and 1 1/8 x 1 1/8 negatives as well as giving high definition and outstanding contrast. The enlarger also incorporates a built-in red filter in a dustproof mount.

AGFA VARIOSCOPI 35/44



ILLUMINATION:

An increase of 40% in light output has been achieved through a new "chimney-effect" design.

Item	Product No.	List Price
Varioscop 35/44	(8700/001) (153-00)	\$229.50

TECHNICAL FEATURES:

150 watt opal lamp, special stepped reflector and aspherical condenser. Special negative holder with sliding masks. Enlarger range with automatic focusing 2 1/2 to 10X linear. Head can also be turned 180° for higher magnifications to floor level (hand focusing).

OPTIONAL EQUIPMENT: For color enlarging the following special accessories are available as optional equipment:

Item	Product No.	List Price
2 3/4 x 2 3/4 in. filter drawer or for continuous filter control, the well-known Agfa Color Head	(8696/000) (18-00)	\$ 27.00
Adapter ring for Agfa Color Head	(8781/120) (216-00)	324.00
Additional condenser for Agfa Color Head	(8698/000) (7-00)	10.50
*Protective cover	(8699/000) (6-00)	9.00
*Negative reading light	(8706/000) (3-30)	4.95
Scale indicator, illuminated	(8704/000) (11-00)	16.50
T 44 negative holder to take 1 1/8 x 1 1/8 negatives on 127 and 120 film	(8701/000) (11-00)	16.50
Single negative carriers with anti-newton glass	(8709/000) (22-00)	33.00
	(8707/000) (22-00)	33.00

*If ordered with enlarger, these accessories will be shipped installed.

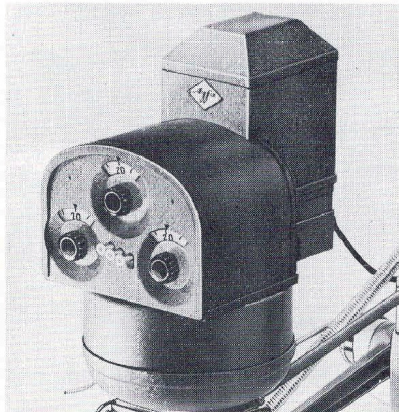

COLOR HEAD

features dial filter setting — an instrumented color filter arrangement which replaces filter packs. With the color head the subtractive (white-light) method of color correcting using a total of three filters, colors yellow, magenta and cyan. Densities to 100 are controlled by simply and quickly turning dials on the front of the Agfa Color Head. This results in stepless, continuous color correction. A total density of 200 is given through a supplementary full-density filter of each color.

Item	Product No.	List Price
COLOR HEAD	(8781/120) (216-00)	\$324.00

ACCESSORIES FOR AGFA COLOR HEAD

Item	Product No.	List Price
Replacement bulb 110 Volt 250 Watt	(8796/105) (3-00)	\$4.50
Replacement bulb 220 Volt 250 Watt	(8795/210) (4-00)	6.00
Variable replacement Filters as follow:		
Yellow	(977/508) (3-90)	5.85
Magenta	(977/509) (3-90)	5.85
Cyan	(977/510) (3-90)	5.85
Supplementary full-density filters		
Yellow	(977/512) (3-90)	5.85
Magenta	(977/511) (3-90)	5.85
Cyan	(977/513) (3-90)	5.85



BINOCULARS



8 X 30

The world famous precision craftsmanship and scientific skill used in all Agfa cameras and lenses have now been applied to the development and production of new Agfa Binoculars. These Binoculars are among the best in performance, detail rendition, sharpness and finish available.

ITEM	LIST PRICE
AGFA Binoculars 8 x 30 with Leather Case (4102/000) (35-97)	\$59.95

FIELD OF VISION—132 yards at 1000 yards
EFFECTIVE CLOSE-UP VIEW—3 yards



10 X 40

Agfa Binoculars have these features: Center focus and eye sight correction on right ocular (± 3 diopters). Prisms and lenses are coated and fully color corrected assuring a sharp and contrasty image. Dust and moisture proof. Removable eye cups permit easy cleaning of oculars.

ITEM	LIST PRICE
AGFA Binoculars 10 x 40 with Leather Case (4111/000) (47-97)	\$79.95

FIELD OF VISION—103 yards at 1000 yards
EFFECTIVE CLOSE-UP VIEW—4 yards

*10% Retailer's Excise Tax applies to the binoculars only, not to the case. For this purpose, the retail value of the Binoculars 8 x 30 alone is \$51.00, and of the Binoculars 10 x 40 alone \$68.50.

8X MAGNIFIER

The clear plastic base, shaped like an egg cup, permits light to completely illuminate the subject viewed. The magnifier is large and virtually free of distortion, affording a sharp 8X magnification. The quality and preciseness of the Agfa Magnifier is perfect for study of negatives, photos, prints, stamps, objects of art, etc.

ITEM	LIST PRICE
AGFA Magnifier (6610/000) (1-92) (12 + 1-59)	\$2.95



COLOR AND BLACK & WHITE FILMS



AGFACHROME CT 18*

Package Quantity 120-127: 25 rolls
 Package Quantity 135-20 135-36: 10 rolls

AGFACOLOR ROLL FILMS

Package Quantity 120-127-620: 25 rolls
 Package Quantity 135-12 135-20: 10 rolls

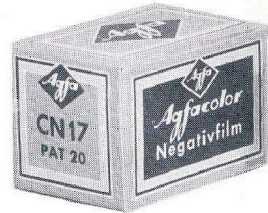

Film Type	Size	List Price
AGFACHROME CT 18	135-20 (2-57) (50+2-44)	\$3.95
AGFACHROME CT 18	135-36 (4-00) (50+3-80)	6.15
AGFACHROME CT 18	120 (2-08) (50+1-98)	3.20
AGFACHROME CT 18	127 (2-08) (50+1-98)	3.20

*Selling price includes Agfa's own processing.
 Agfachrome CT 18 35mm and roll film can be assorted for maximum discount.

Film Type	Size	List Price
AGFACOLOR CN 17	120 (0-78*)	\$ 1.15
AGFACOLOR CN 17	135-20 (1-25*)	1.85
AGFACOLOR CN 17	127 (0-78*)	1.15
AGFACOLOR CN 17	620 (0-78*)	1.15
AGFACOLOR CN 17 "Weekend Film"	135-12 (0-97*)	1.45
AGFACOLOR CN 17	35mm x 100 ft. (26-67)	40.00

*100 rolls of Agfacolor and Agfa Isopan film can be assorted for additional 5% discount.

AGFA BLACK AND WHITE FILMS

Package Quantity 120-127-620: 25 rolls
 Package Quantity 135-20 135-36: 10 rolls

70mm PERFORATED FOR LINHOF CINE ROLLEX

Film Type	Size	List Price
ISOPAN IFF	120 (0-39*)	\$.65
	135-36 (0-72*)	1.20
ISOPAN IF	120 (0-33*)	.55
	127 (0-33*)	.55
	620 (0-33*)	.55
	135-20 (0-51*)	.85
	135-36 (0-66*)	1.10
ISOPAN ISS	120 (0-33*)	.55
	127 (0-33*)	.55
	620 (0-33*)	.55
	135-20 (0-51*)	.85
ISOPAN ULTRA	120 (0-39*)	.65
	127 (0-39*)	.65
	135-36 (0-72*)	1.20
ISOPAN RECORD	120 (0-48*)	.80
	135-36 (0-90*)	1.50

Film Type	Size	List Price
AGFACOLOR CN 17	70mm x 100 ft. (54-00)	\$81.00

AGFACOLOR CN 17 SHEET FILM

Sizes	No. of Sheets	List Price
2 1/4 x 3 1/4 inch	10 (2-57)	\$ 3.95
4 x 5 inch	10 (5-26)	8.10
5 x 7 inch	10 (8-09)	12.45
8 x 10 inch	10 (17-82)	27.40

AGFACOLOR POSITIVE FILM S (Slide Film)

to make color slides from Agfacolor negatives.

Size	No. of Sheets	List Price
35mm x 33 ft.	(4-13)	\$ 5.50
4 x 5 inch	10 (2-60)	4.00
5 x 7 inch	10 (4-39)	6.75
8 x 10 inch	10 (9-65)	11.85

8mm AGFA BLACK-AND-WHITE MOVIE FILM

For single 8mm Agfa Movex camera in Movex cassette. Price includes processing in one of the authorized labs listed in film package insert. For processing user must mail film directly.

Film Type	Size	List Price
ISOPAN IF	8mm x 33 ft. (1-73)	\$2.60
ISOPAN ISS	8mm x 33 ft. (1-73)	2.60

16mm AGFA BLACK-AND-WHITE MOVIE FILM

For 16mm Siemens camera in Siemens cassette. Price includes processing in one of the authorized labs listed in film package insert. For processing user must mail film directly.

Film Type	Size	List Price
ISOPAN IF	16mm x 50 ft. (3-30)	\$4.95
ISOPAN ISS	16mm x 50 ft. (3-30)	4.95

AGFA SHEET FILMS

ISOPAN IFF
 ISOPAN IP CLEAR BASE
 ISOPAN IP MATTE BASE
 ISOPAN ULTRA

Size	No. of Sheets	List Price
2 1/4 x 3 1/4	25 (1-43)	\$2.20
4 x 5	25 (2-57)	3.95
5 x 7	25 (4-06)	6.25

ISOPAN RECORD	Size	No. of Sheets	List Price
	4 x 5	25 (3-19)	4.90



AGFACOLOR AND BLACK & WHITE FILMS

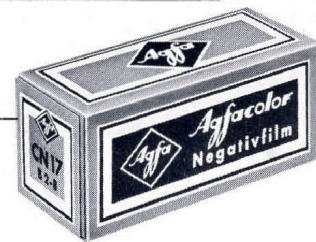

COLOR

Agfacolor Negative Film	Film Type	Filter*	Exposure Index	Processing
CN 17 for all-purpose picture taking, medium speed and medium fine grain.	Dual-Purpose: Indoors and Outdoors.			For the present time only authorized processor: Perfect Photo, Inc. P.O. Box 7100 Philadelphia 17, Pa.
	Daylight	None	40 ASA	
	Before 9 AM and after 4 PM	KB 3 (82A)**	25 ASA	
	Open shade	R 1.5 (Skylight)	40 ASA	
	Clear Flash	None	32 ASA	
	3400 K Flood	KB 3 (82A)	25 ASA	
	3200 K Flood	KB 6 (82C)	25 ASA	
Electr. Flash	KR 12 (85)	16 ASA		
CN 14 very fine grain slow-speed film for extreme enlargements.	Dual-Purpose: Indoors and Outdoors.			Perfect Photo, Inc. P.O. Box 7100 Philadelphia 17, Pa.
	Daylight	None	20 ASA	
	Before 9 AM and after 4 PM	KB 3 (82A)**	12 ASA	
	Open shade	R 1.5 (Skylight)	20 ASA	
	Clear Flash	None	16 ASA	
	3400 K Flood	KB 3 (82A)	12 ASA	
	3200 K Flood	KB 6 (82C)	10 ASA	
Electr. Flash	KR 12 (85)	8 ASA		

*For available filter sizes refer to page
**Use only if cooler effect is desired.



BLACK AND WHITE

Type	Film Properties	Specifications	Exposure Index
AGFA ISOPAN IFF	Extremely fine grain, panchromatic roll and sheet film of low speed yielding negatives of maximum quality suited for extreme enlargements.	Single layer emulsion (6 μ); resolving power 185 lines/mm; contour sharpness* k = 18 μ	Daylight 16 Tungsten 12
AGFA ISOPAN IF	Very fine grain, panchromatic roll film of wide latitude and moderate speed, best choice for all-round picture taking.	Single layer emulsion (10 μ); resolving power 150 lines/mm; contour sharpness k = 22 μ	Daylight 40 Tungsten 32
AGFA ISOPAN IP 21	Fine grain, panchromatic sheetfilm with clear or matte backing, medium speed and very wide latitude. Matte backing permits direct retouching without use of medium.	Single layer emulsion (11 μ); resolving power 85 lines/mm; contour sharpness k = 24 μ	Daylight 100 Tungsten 80
AGFA ISOPAN ISS	Fine grain panchromatic roll film of medium speed and very wide latitude; for limited light conditions.	Single layer emulsion (18 μ); resolving power 80 lines/mm; contour sharpness k = 35 μ	Daylight 100 Tungsten 80
AGFA ISOPAN ULTRA	High-speed, available light roll and sheet film for in- and outdoor use with exceptional latitude and moderate fine grain. Extremely sensitive to Tungsten light.	Single layer emulsion (16 μ); resolving power 80 lines/mm; contour sharpness k = 30 μ	Daylight 250 Tungsten 400
AGFA ISOPAN RECORD	Super fast, available light roll and sheet film, grainy, however of very even grain structure. Exceptional wide latitude.	Double layer emulsion (19 μ); resolving power 75 lines/mm; contour sharpness k = 30 μ	Daylight 640 Tungsten 640 **

*Contour sharpness, about the same as acutance, is a measure in addition to resolving power. The lower the k-value, the better the contour sharpness.

**Best results will be obtained at a speed rating of 1250 ASA and normal light conditions. At contrasty light conditions, 640 ASA should be used. For flash use guide number four times of 40 ASA.

AGFACOLOR AND BLACK & WHITE FILMS



AGFA BLACK AND WHITE ROLL FILMS

Package Quantity 120-127-620: 25 rolls
 Package Quantity 135-20 135-36: 10 rolls

Film Type	Size		List Price
ISOPAN IFF	120	(1710 0-36*)	\$.60
	135-36	(1820 0-71*)	1.20
ISOPAN IF	120	(1711 0-30*)	.50
	127	(1701 0-30*)	.50
	620	(1720 0-30*)	.50
	135-20	(1810 0-51*)	.85
	135-36	(1821 0-66*)	1.10
	135-12 (Karat)	(1801 0-39*)	.65
ISOPAN ISS	120	(1712 0-30*)	.50
	127	(1702 0-30*)	.50
	620	(1721 0-30*)	.50
	135-20	(1811 0-51*)	.85
	135-36	(1822 0-66*)	1.10
135-12 (Karat)	(1802 0-39*)	.65	
ISOPAN ULTRA	120	(1713 0-36*)	.60
	127	(1703 0-36*)	.60
	135-36	(1823 0-71*)	1.20
ISOPAN RECORD	120	(1714 0-45*)	.75
	135-36	(1824 0-89*)	1.50

*100 rolls of Agfacolor and Agfa Isopan film can be assorted for additional 5% discount.

AGFA FILM IN ROLLS

For darkroom loading; frame numbered, perforated, on wooden core.

Film Type	Size		List Price
ISOPAN IFF	35mm x 56 ft.	(1850 3-40)	\$ 5.10
ISOPAN IF	35mm x 56 ft.	(1851 3-00)	4.50
ISOPAN ISS	35mm x 56 ft.	(1852 3-00)	4.50
ISOPAN ULTRA	35mm x 56 ft.	(1853 3-40)	5.10
ISOPAN RECORD	35mm x 100 ft.	(1860 8-63)	12.95

AGFA SHEET FILMS

ISOPAN IFF
 ISOPAN IP CLEAR BASE
 ISOPAN IP MATTE BASE
 ISOPAN ULTRA

Sizes	No. of Sheets		List Price
2¼ x 3¼	25	(1-43)	\$ 2.20
4 x 5	25	(2-44)	3.95
5 x 7	25	(3-86)	6.25
8 x 10	25	(8-27)	13.10
ISOPAN RECORD			
4 x 5	25	(3-19)	4.90

AGFA COLOR ROLL FILMS

Package Quantity 120-127-620: 25 rolls
 Package Quantity 135-20: 10 rolls

Film Type	Size		List Price
AGFACOLOR CN 14	135-20	(2401 1-30*)	\$1.95
AGFACOLOR CN 17	120	(2302 0-84*)	1.25
	127	(2301 0-84*)	1.25
	620	(2303 0-84*)	1.25
	135-20	(2411 1-30*)	1.95

*100 rolls of Agfacolor and Agfa Isopan film can be assorted for additional 5% discount.

AGFACOLOR PREPAID PROCESSING MAILERS

(FOR PROCESSING BY PERFECT PHOTO)

Type		List Price
For Agfacolor CN 17 8 exp. 120, 127, 620	(9950 1-93)	\$3.22
For Agfacolor CN 17 12 exp. 120, 127, 620	(9951 2-63)	4.38
For Agfacolor CN 17 and CN14 20 exp. 135-20	(9952 2-94)	4.90

8mm AGFA BLACK-AND-WHITE MOVIE FILM

For single 8mm Agfa Movex camera in Movex cassette. Price includes processing in one of the authorized labs listed in film package insert. For processing user must mail film directly.

Film Type	Size		List Price
ISOPAN IF	8mm x 33 ft.	(2601 1-73)	\$2.60
ISOPAN ISS	8mm x 33 ft.	(2602 1-73)	2.60

16mm AGFA BLACK-AND-WHITE MOVIE FILM

For 16mm Siemens camera in Siemens cassette. Price includes processing in one of the authorized labs listed in film package insert. For processing user must mail film directly.

Film Type	Size		List Price
ISOPAN IF	16mm x 50 ft.	(2605 3-30)	\$4.95
ISOPAN ISS	16mm x 50 ft.	(2606 3-30)	4.95



DATA AGFACHROME CT 18

AGFACHROME, known in Europe as Agfacolor CT 18, is a reversal color film, producing full-color transparencies for projection or gorgeous color photographs. It is designed for daylight (5500 K), with a suggested exposure index of ASA 50 without filters.

AVAILABILITY: At present, Agfachrome is supplied in 20- and 36-exposure 35mm daylight-loading cassettes and in 120 and 127 roll film sizes.

GRAIN: Fine.

RESOLVING POWER: Approximately 80 lines/mm.

GRADATION: When exposed and processed normally, Agfachrome transparencies have a gamma of 1.6-1.8.

EMULSION: Agfachrome uses three emulsions with dye-couplers in the emulsion.

LIGHT: Agfachrome may be used with daylight, blue-flashbulbs or electronic flash. Used with other types of light sources, color accuracy will suffer.

SPECTRAL CHARACTERISTICS: (CURVES)

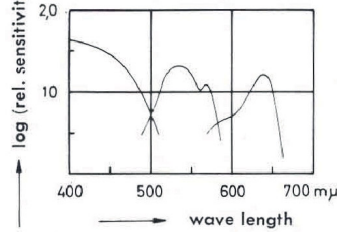

COLOR RESPONSE: (CURVES)

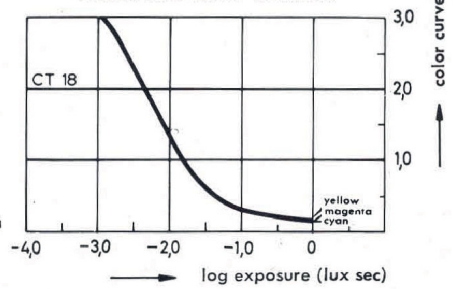

FILTER RECOMMENDATIONS: For normal daylight use, no filter is required with Agfachrome. However, for mountain or seashore, a light UV filter may be used. For more pronounced contrast, a polarizing filter can be used with an exposure factor of at least 2 (one stop more). Use of black-and-white filters will only result in color distortion.

FLASH FACTORS: For electronic flash, use a guide number equal to the guide number of a black-and-white film with an exposure index of 25 ASA. For blue flash bulbs, use a flash factor equal to that of a black-and-white film of the same speed (50 ASA).

Due to the wide variation in flash units, the above recommendation should be considered as a guide only. For best results, make a series of test exposures to determine the correct guide number for a particular unit.

STORAGE: Agfachrome, like any other film, should be stored in a cool, dry place, with a temperature not over 68 deg. F and a relative humidity between 50 and 60%. For best results, do not store film too long; any film is best when it is freshest.

SIZES: Agfachrome film is available in 135-20, 135-36, 120 and 127.

PROCESSING: Agfachrome reversal film is processed in Agfa's own plant in New York City and in 21 other processing stations throughout the world. In other countries Agfachrome is marketed under the name of AGFACOLOR CT 18.

	Sensitivity	Color Component
outer layer	Blue	Yellow
filter	Silver	
middle layer	Green	Purple
bottom layer	Red	Blue-green

Thickness of the Agfachrome emulsions totals 20-22 microns.

Acetate base of 35mm Agfachrome measures about 0.13mm. Roll film measures about 0.10mm.

DATA AGFACOLOR CN 17

Agfacolor CN 17 is a color negative film producing full color or black and white prints or color slides for projection.

Either daylight tungsten electronic or regular flash light can be used at an exposure index of ASA 40.

EXPOSURE INDEX: Daylight 40 ASA.

DAYLIGHT EXPOSURES:

May to August 2 hours after sunrise until 2 hours before sunset	Aperture for 1/100 or 1/125, light values in brackets () bright sunshine haze overcast, dull		
Beach, glaciers, snow	f 11-16 (14½)	f 8-11 (13½)	f 5.6-8 (12½)
Open landscapes	f 8-11 (13½)	f 5.6-8 (12½)	f 4-5.6 (11½)
Landscapes w/foreground	f 5.6-8 (12½)	f 4-5.6 (11½)	f 2.8-4 (10½)
People in the open	f 5.6-8 (12½)	f 4-5.6 (11½)	f 2.8-4 (10½)
Portraits (close-ups) in shade	f 4-5.6 (11½)	f 2.8-4 (10½)	f 2-2.8 (9½)

For all pictures against the light and during months when the light is poor (September to April), the next larger aperture or next lower light value should be used.

SUPPLEMENTARY FLASH OUTDOORS: Fill-in light, blue flash lamps only.

Lamp No.	Distance	Lens opening	Shutter time
5B, 2B or 22B	7-14 feet	f/8	1/100 } M synchron.
25B in polished reflector	9-18 feet	f/16	1/50 }

FLASH LAMPS: Divide the guide number by the lamp-to-subject distance in feet to determine the lens opening for average subjects.

		X-synch.		M-synch.	
		1/25	1/50	1/100	1/200
Clear flash lamps:	(use indoors and outdoors at night)	1/30	1/60	1/125	1/250
SM or SF	in 4 to 6" polished reflector	80	75	70	60
5 or 25	in 4 to 6" polished reflector	140	120	110	100
6 or 26	in 4 to 6" polished reflector	130	100	90	70
M 2	in 4 to 6" polished reflector	100			
AG 1	in 2" polished reflector	70	60	50	40
2 or 22	in 6 to 7" polished reflector	280	240	220	180
11 or 40	in 6 to 7" polished reflector	180	160	140	120

		X-synch.		M-synch.	
		1/25	1/50	1/100	1/200
Blue flash lamps:	(use outdoors in daylight)	1/30	1/60	1/125	1/250
AG 1B	in 2" polished reflector	50	40	35	30
5B or 25B	in 4 to 6" polished reflector	100	90	80	75
M 2B	in 3" polished reflector	80			
2B or 22B	in 6 to 7" polished reflector	180	160	140	120
11B or 40B	in 6 to 7" polished reflector	120	100	80	60

ELECTRONIC FLASH UNITS:

Effective candle power seconds per	700	1000	1400	2000	2800	4000	5600	8000
output (ECPS)	22	28	32	40	50	55	65	75

LIGHT SOURCES: Suitable light sources are:

- Group 1) Daylight, electronic flash, blue flash bulbs.
- Group 2) Clear flash bulbs, cap flash bulbs, flash powder.
- Group 3) Photo lamps, normal electric light bulbs.

Lighting sources of the same group (for example, daylight and electronic flash) can also be used together, but lighting from different groups (mixed light) produces color distortion. Maximum brilliance in all color is obtained by direct illumination of the subject from the front. With side lighting, heavy shadows should be brightened by using white reflecting surfaces or adding light of the same group (fill-in).

Photo flood and 3200° K lamps: use lightmeter for exact data.

FILTERS:

Agfacolor Negativfilm CN 17 is a universal film for daylight and tungsten, therefore film can be used without filter.

Suggested correction filters for CN 17. For pictures in the mountains or at the beach a clear UY filter is advisable (no exposure increase needed). Neutral grey polarizing filters can also be used.

AGFACOLOR NEGATIVE CN 17 — ASA 40

Flood (3200K)	82C	25 ASA
Flood (3400K)	82A	25 ASA
Clear Flash		32 ASA
Electronic Flash	85	16 ASA
Daylight: Before 9 A.M. or after 4 P.M.	82A	25 ASA

PROCESSING: Processing charges are not included in the film price. Please take this film to your Agfa dealer who will furnish processing.

BLACK & WHITE PRINTS: Can be made on any black & white paper, especially on Agfa Brovira. Ask your Agfa dealer.

KEEPING AND STORAGE: Agfacolor negative films should be kept in a cool, dry place (temperatures up to 68° F, 50-60% relative humidity). The keeping properties of the films are guaranteed (if properly stored) only for the period shown on the package. The films are suitable for use in the tropics provided certain precautions are observed.

SIZES OF AGFACOLOR NEGATIVE FILM CN 17: 135, 127, 120, 620, 4 x 5", 5 x 7", 8 x 10".

COLOR AND BLACK & WHITE FILMS



AGFACHROME CT-18*

Package Quantity 120-127: 25 rolls
 Package Quantity 135-20 135-36: 10 rolls

Film Type	Size	List Price
AGFACHROME CT 18	135-20 (2-80) (60+2-66)	\$4.20
AGFACHROME CT 18	135-36 (4-30) (60+4-09)	6.45
AGFACHROME CT 18	120 (2-33) (60+2-21)	3.50
AGFACHROME CT 18	127 (2-33) (60+2-21)	3.50

*Selling price includes Agfa's own processing.
 Agfachrome CT 18 35mm and roll film can be assorted for maximum discount.

AGFACOLOR CN 17 ROLL FILMS

Package Quantity 120 : 25 rolls
 Package Quantity 135-20: 10 rolls

Film Type	Size	List Price
AGFACOLOR CN 17	120 (0-78*)	\$ 1.15
AGFACOLOR CN 17	135-20 (1-25*)	1.85

*100 rolls of Agfacolor and Agfa Isopan film can be assorted for additional 5% discount.

SHEET FILM

Size	No. of Sheets	List Price
2 1/4 x 3 1/4 inch	10 (2-57)	\$ 3.95
4 x 5 inch	10 (5-26)	8.10
5 x 7 inch	10 (8-09)	12.45
8 x 10 inch	10 (17-82)	27.40

AGFACOLOR POSITIVE FILM S (Slide Film)

to make color slides from Agfacolor negatives.

Size	No. of Sheets	List Price
35mm x 33 f	(4-13)	\$ 5.50
4 x 5 inch	10 (2-60)	4.00
5 x 7 inch	10 (4-39)	6.75
8 x 10 inch	10 (9-65)	11.85

AGFA BLACK & WHITE FILMS

Package Quantity 120-127-620: 25 rolls
 Package Quantity 135-20 135-36: 10 rolls

Film Type	Size	List Price
ISOPAN IFF	120 (0-39*)	\$.65
	135-36 (0-72*)	1.20
ISOPAN IF	120 (0-33*)	.55
	127 (0-33*)	.55
	620 (0-33*)	.55
	135-20 (0-51*)	.85
	135-36 (0-66*)	1.10
135-12 (Karat)	(0-39*)	.65
ISOPAN ISS	120 (0-33*)	.55
	127 (0-33*)	.55
	620 (0-33*)	.55
	135-20 (0-51*)	.85
	135-36 (0-66*)	1.10
135-12 (Karat)	(0-39*)	.65
ISOPAN ULTRA	120 (0-39*)	.65
	127 (0-39*)	.65
	135-36 (0-72*)	1.20
ISOPAN RECORD	120 (0-48*)	.80
	135-36 (0-90*)	1.50

*100 rolls of Agfacolor and Agfa Isopan film can be assorted for additional 5% discount.

35mm AGFA FILM IN BULK

Darkroom loading; frame numbered, perforated, wooden core.

Film Type	Size	List Price
ISOPAN IFF	35mm x 56 ft. (3-40)	\$ 5.10
ISOPAN IF	35mm x 56 ft. (3-00)	4.50
ISOPAN ISS	35mm x 56 ft. (3-00)	4.50
ISOPAN ULTRA	35mm x 56 ft. (3-40)	5.10

AGFA SHEET FILMS

Film Type	Size	No. of Sheets	List Price
ISOPAN IFF	2 1/4 x 3 1/4	25 (1-43)	\$2.20
ISOPAN IP CLEAR BASE	4 x 5	25 (2-57)	3.95
ISOPAN IP MATTE BASE	5 x 7	25 (4-06)	6.25
ISOPAN ULTRA			

Film Type	Size	No. of Sheets	List Price
ISOPAN RECORD	4 x 5	25 (3-19)	4.90

AGFAPAN

(Black and White Film for Outdoor Use or Flash)

Sizes: 120 or 620 or 127

List Price

Agfapan SINGLEPAK carded (0-26)*

.39

Agfapan DUOPAK carded (0-46)*

.69

AGFAPAN SELF-SERVICE OR DISPLAY RACK

Contents:

AGFAPAN Sizes	DUOPAKS Quantity	SINGLE PAKS Quantity	MAGNIFIER 8X Quantity	Total List
#120	40	20	20	
#620	40	20		
#127	60	20		
	140 @ 46¢	60 @ 26¢	20 @ 99¢	159.60

Net: Complete with Counter Display 99-80

*Minimum reorder 20 or multiples of 20



The following Agfa papers listed below are regularly stocked at Agfa branch warehouses. For sizes or surfaces not listed contact the Agfa sales office nearest you.

Agfa photographic papers are distinguished by their rich silver content and by exceptionally wide exposure and developing latitude. White Brovira and Record Rapid papers contain Blancophores (White Toners) which increase their tonal range to a brilliant white.



AGFA BROVIRA

Single and double weight enlarging papers are available in the following surfaces and weights:

Agfa Brovira 1	Single weight, white glossy, neutral black tone
Agfa Brovira 2a	Single weight, white, fine grained, lustre, neutral black tone
Agfa Brovira 22a	Single weight, cream, velvet, lustre, warm black tone
Agfa Brovira 111	Double weight, white glossy, neutral black tone
Agfa Brovira 113	Double weight, white matte, neutral black tone
Agfa Brovira 117	Double weight, white silk, neutral black tone
Agfa Brovira 119	Double weight, white crystal, neutral black tone

AGFA RECORD RAPID

Single weight enlarging paper yields warm black tones and can be ferro-typed to a high gloss. It is ideal for industrial, commercial and publicity purposes.

Agfa Record Rapid 1	Single weight, white glossy, warm black tone
----------------------------	--

AGFA PORTRIGA RAPID

A classic chlorobromide enlarging paper of high speed and long scale, yielding warm black to brown black tones. Its artistic surface qualities make it the perfect paper for exhibition prints, portraits, etc.

Agfa Portriga Rapid 111	Double weight, white glossy, warm tone
Agfa Portriga Rapid 112	Double weight, white matte, warm tone
Agfa Portriga Rapid 114e	Double weight, white, classic portrait, warm tone
Agfa Portriga Rapid 118	Double weight, white, filigran, warm tone

AGFA LUPEX

A fast, graded contact paper for richer, deeper blacks. Lupex has exceptional resistance to abrasions and scratches.

Agfa Lupex I	Single weight, white glossy, neutral black tone
---------------------	---



BROVIRA—Single Weight RECORD RAPID—Single Weight

Size	No. of Sheets Per Package	Per Package		Brovira 1	Brovira 2a	Brovira 22a	Record Rapid 1
		List	Net				
2¾ x 3¾	500	\$ 6.15	\$ 4.00	1 2 3 4 5 6	2 3 4 5 6		
3 x 4¼	500	7.25	4.71	1 2 3 4 5 6	2 3 4 5 6	1 2 3 4 5 6	
3¼ x 4½	500	8.30	5.40	1 2 3 4 5 6	2 3 4 5 6		
3½ x 3½	500	7.25	4.71	1 2 3 4 5 6	2 3 4 5 6	1 2 3 4 5 6	
3½ x 5	500	9.70	6.31	1 2 3 4 5 6	2 3 4 5 6	1 2 3 4 5 6	
4 x 4	500	9.00	5.85		2 3 4 5 6	1 2 3 4 5	
4 x 5	100	2.60	1.69	1 2 3 4 5 6	2 3 4 5 6	1 2 3 4 5	
5 x 7	25	1.30	.85	1 2 3 4 5 6	2 3 4 5 6	1 2 3 4 5 6	2 3 4 5
	100	4.30	2.80	1 2 3 4 5 6	2 3 4 5 6	1 2 3 4 5	2 3 4 5
	500	18.15	11.80	1 2 3 4 5 6	2 3 4 5 6	1 2 3 4 5	2 3 4 5
8 x 10	25	2.70	1.76	1 2 3 4 5 6	2 3 4 5 6	1 2 3 4 5 6	2 3 4 5
	100	9.40	6.11	1 2 3 4 5 6	2 3 4 5 6	1 2 3 4 5	2 3 4 5
	500	39.85	25.90	1 2 3 4 5 6	2 3 4 5 6	1 2 3 4 5	2 3 4 5
8½ x 11	500	47.60	30.94	2 3			
11 x 14	10	2.10	1.37	1 2 3 4 5 6	2 3 4 5 6		2 3 4 5
	50	9.05	5.88	1 2 3 4 5 6	2 3 4 5 6		2 3 4 5

BROVIRA—Double Weight

Size	No. of Sheets Per Package	Per Package		Brovira 111	Brovira 113	Brovira 117	Brovira 119
		List	Net				
5 x 7	25	1.70	1.11	1 2 3 4 5 6	2 3 4 5	2 3 4 5	2 3 4 5
	100	5.65	3.67	1 2 3 4 5 6	2 3 4 5	2 3 4 5	2 3 4 5
	500	23.75	15.44	1 2 3 4 5 6	2 3 4 5	2 3 4 5	2 3 4 5
8 x 10	25	3.55	2.31	1 2 3 4 5 6	2 3 4 5	2 3 4 5	2 3 4 5
	100	12.30	8.00	1 2 3 4 5 6	2 3 4 5	2 3 4 5	2 3 4 5
	250	26.90	17.49	1 2 3 4 5 6	2 3 4 5	2 3 4 5	2 3 4 5
11 x 14	10	2.75	1.79	1 2 3 4 5 6	2 3 4 5	2 3 4 5	2 3 4 5
	50	11.85	7.70	1 2 3 4 5 6	2 3 4 5	2 3 4 5	2 3 4 5
14 x 17	10	4.20	2.73	1 2 3 4 5 6	2 3 4 5	2 3 4 5	2 3 4 5
	50	18.10	11.77	1 2 3 4 5 6	2 3 4 5	2 3 4 5	2 3 4 5
16 x 20	10	5.55	3.61	1 2 3 4 5 6	2 3 4 5	2 3 4 5	2 3 4 5
	50	24.15	15.70	1 2 3 4 5 6	2 3 4 5	2 3 4 5	2 3 4 5

LUPEX—Single Weight (CONTACT PAPER)

Size	No. of Sheets Per Package	Per Package		Lupex I
		List	Net	
4 x 5	100	2.30	1.50	1 2 3 4 5
5 x 7	25	1.15	.75	1 2 3 4 5
	100	3.85	2.50	1 2 3 4 5
8 x 10	25	2.40	1.56	1 2 3 4 5
	100	8.40	5.46	1 2 3 4 5



PORTRIGA RAPID—Double Weight

Size	No. of Sheets Per Package	Per Pkg.		Portrigo Rapid 111	Portrigo Rapid 112	Portrigo Rapid 114e	Portrigo Rapid 118
		List	Net				
5 x 7	25	\$ 1.90	\$1.24	2 3 4	2 3 4	2	2 3 4
	100	6.25	4.06	2 3 4	2 3 4	2	2 3 4
8 x 10	25	3.95	2.57	2 3 4	2 3 4	2	2 3 4
	100	13.70	8.91	2 3 4	2 3 4	2	2 3 4
11 x 14	10	3.05	1.98	2 3 4	2 3 4	2	2 3 4
	50	13.15	8.55	2 3 4	2 3 4	2	2 3 4
14 x 17	10	4.65	3.02	2 3 4	2 3 4	2	2 3 4
16 x 20	10	6.20	4.03	2 3 4	2 3 4	2	2 3 4

AGFA VARITEX RAPID

Size	Per Roll		Varitex Rapid 1	Varitex Rapid 21
	List	Net		
3 x 500	\$20.00	\$13.00		x
3¼ x 500	21.60	14.04		x
3½ x 500	23.10	15.02		x
3 x 1000	30.00	19.50		x
3¼ x 1000	32.40	21.06		x
3½ x 1000	34.80	22.62	x	x
3¾ x 1000	37.20	24.18		x



AGFA RODINAL: Liquid universal developer in high concentration with the following characteristics: Dilution to 1:100 according to film speed • Ideal for thin emulsion—high acutance films as AGFA Isopan IFF (16ASA) and AGFA Isopan IF (40ASA) • Extremely economical and simple to use—stock solution keeps indefinitely, dilutions after use are discarded.

Size	List Price
3 oz. bottle (3201 1-00) (10+3201 0-90)	\$1.50 (Standard case 10 bottles)
16 oz. bottle (3202 2-63) (10+3202 2-37)	3.95

AGFA ATOMAL: Special developer for the finest possible grain combined with maximum emulsion speed and good keeping properties. Requires no increase in exposure.

Size	List Price
11 oz. solution (3210 0-45) (10+3210 0-40)	\$.75 (Standard package 5 units)
21 oz. solution (3211 0-70) (10+3211 0-65)	1.20 (Standard package 5 units)

The combination of both sizes yields one quart.

AGFA NEUTOL: Universal print developer giving unvarying quality of gradation over a long working life. Image tone remains unchanged to the point of exhaustion. AGFA Brovira papers yield neutral black and AGFA Portriga Rapid warm black tones.

Size	List Price
7 oz. solution (3230 0-30) (10+3230 0-27)	\$.50 (Standard package 5 units)
35 oz. solution (3231 0-57) (5+3231 0-53)	.95 (Standard package 5 units)
2¾ qt. solution (3232 1-11) (5+3232 1-00)	1.85

AGFA PINA WHITE: Desensitizer to be added to developer allows development by inspection, or to be used as forebath by diluting 1 gram in one quart of water and adding 30 grams of Sodium Sulfite, Anhyd.

Size	List Price
1 gram, to be added to 1 qt. of developer or to make 1 qt. of forebath (3250 0-90) (10+3250 0-81)	\$1.50
10 grams, to be added to 10 qts. of developer or to make 10 qts. of forebath (3251 3-90) (5+3251 3-51)	6.50

AGFA FIXING AID: For determination of hypo and silver concentration and of general acidity of the fixing bath. Contains 2 rubber balls and test paper.

	List Price
AGFA FIXING AID (3260 0-66)	\$1.00

AGFA MAGNETON TAPE



AGFA PE (polyester) tape is an entirely new high fidelity tape for the recording of music and speech and has many unparalleled electro-acoustical and mechanical advantages.

AGFA MAGNETON TAPE BASE is manufactured of pre-stressed polyester in which a completely new wear-resisting binder of specially treated iron oxide is embedded. The pre-stretching process increases its stretch-resistance and tensile strength resulting in undistorted recordings over a long life.

Technical Data

Frequency range at 3¾ in./sec. 40-16,000 cps
 Frequency range at 1⅞ in./sec. 40- 8,000 cps

Tensile strength in comparison to steel:

Agfa PE tape 25-45 kg/mm²
 Steel 28 kg/mm²

Free of distortion when overloaded.

Fidelity of recordings of speech and music is achieved by Agfa's experience in uniform coating of the magnetic layer.

Sensitivity tolerance:

within an individual tape ±½ db
 from one batch to another ± 1 db

Abrasion proof coating PROTECTS the recording sound head as well as the magnetic layer of the tape.

Unaffected by heat, humidity, freeze or chemical solvents such as acetone, benzene, etc.



LONG PLAY

Agfa PE 31 magnetic tape: (¼ in. wide)

Type	Size	Playing time at		List Price
		3¾ in./sec. (9.5cm/sec.)	1⅞ in./sec. (4.75cm/sec.)	
PE 31	900 ft., 5 in. reel	45 min	90 min	(9021 2-40) (12+9021 2-16*) \$3.60
PE 31	1800 ft., 7 in. reel	90 min	180 min	(9023 4-14) (12+9023 3-72*) 6.20
PE 31S	440 ft., Editing Tape			(9001 2-17) (12+9001 1-95*) 3.25

DOUBLE PLAY

Agfa PE 41 magnetic tape: (¼ in. wide)

PE 41	1200 ft., 5 in. reel	60 min	120 min	(9031 3-63) (12+9031 3-27*) \$5.45
PE 41	2400 ft., 7 in. reel	120 min	240 min	(9033 6-34) (12+9033 5-70*) 9.50

*Can be assorted

AGFA MAGNETON TAPE ACCESSORIES

Item	List Price
Editing Kit, containing: 3 rolls of 80 ft. leader tape in red, green and white, 1 roll of 33 ft. silver contact tape, 33 ft. splicing tape, splicer, scissors.	(8755 2-63) (12+8755 2-37) \$3.95
Splicing Tape 80 ft.	(8721 0-46) .69
Leader Timing Tape 80 ft. (red, green or white)	(8701 0-34) (12+8701 0-30) .50
Silver Contact Tape 33 ft.	(8740 0-54) (12+8740 0-48) .80
Tape Clips (25 per box)	(8750 0-84) 1.25
Tape File Container, center swiveled, for 5 in. reels	(8770 0-54) (12+8770 0-48) .80
Tape File Container, center swiveled, for 7 in. reels	(8772 0-84) (12+8772 0-75) 1.25

AGFA WINDOW, COUNTER and BACK COUNTER DISPLAYS



EXTERIOR STORE ADVERTISING MATERIALS

Use these beautifully designed and colorful "point of sale" materials ... They create store traffic and sales!



No Charge. Must be installed within six weeks after receipt. Otherwise can be recalled.

1-61

Agfa Outdoor Transparency Measures 45" x 41 1/8", weight about 50 lbs. Blue Diamond is on orange background, illuminated by two 25 watt fluorescent lamps.



3-61

Agfa Outdoor Transparency Measures 44" x 31" x 5 1/2", weight about 25 lbs. Blue Diamond is on orange background, illuminated by one round fluorescent 40 watt light.



11-61
Agfa Film Stool
Measures
22 1/2" x 11" x 11"
\$2.50

INTERIOR STORE ADVERTISING MATERIALS



28-61
Agfa Ashtray (Glass)
\$.75

9-61
Agfa Giant Thermometer,
19 3/4" long.
\$2.50

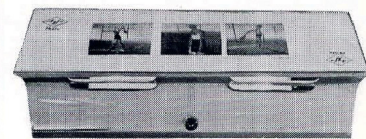

20-61
Agfa Negative Viewer Measures
12" x 4" x 4 1/2", illuminated by
two 15 watt lamps.
\$5.95



44-61
Window Streamer
Window Streamer for Agfa Bl. &
White Films (Colored), 12" x 28".
no charge



10-61
Agfa Flag
Measures 18" x 36"
Plasticfoil in the Agfa
colors.
no charge

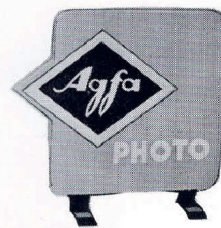

15a-61
Agfa Photo Plastic-Display
Measures: 6 1/2" x 5 1/2"
no charge



54-60
Illuminated Picture Frame for
Agfacolor Enlargements 20" x 24".
\$12.50



53-61 Agfa Optima Dummy (Plastic)
Measures: 18 1/2" x 9 1/2" x 11 3/4" \$7.50

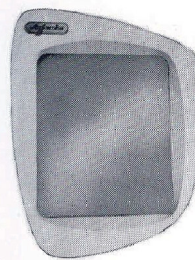

99-61
Frame for Agfacolor Enlarge-
ments for the size 20" x 24"
\$3.50

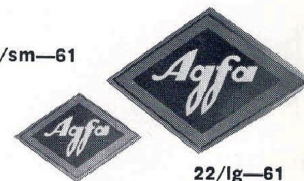

22/sm-61
22/lg-61
AGFA Trade Mark (Carton)
22/sm/61 11 inches
22/lg/61 16 inches
no charge



25-61 Windowsticker "Agfacolor"
26-61 Windowsticker "Agfa"
no charge

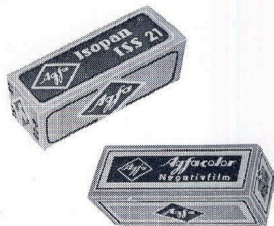

ROLLFILM (Carton)
23/sm/ci-61 8" (Color Film)
23/sm/bw-61 8" (Black & White Film)
23/lg/bw-61 16" (Black & White Film)
no charge



54-61
Agfa Bright Orange
Counter Mat
13 1/2" x 17 1/2"
no charge



13a-61
Agfa Illuminated Trade Mark
(Plastic) Measures: 20" x 12 1/2"
\$10.00

NUMBERS 1-61 and 11-61 are temporarily not available.

WINDOW, COUNTER and BACK COUNTER DISPLAYS



50-61 Wire stand for 1 Optima \$1.00
 50R-61 Wire stand for 1 Optima Reflex \$1.00

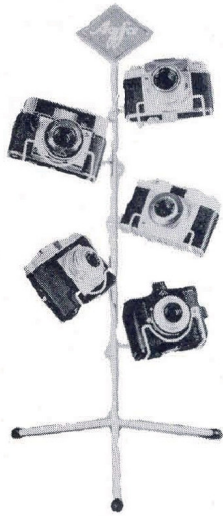

47-61 Agfa Tree. Wire stand for 5 cameras. \$1.00

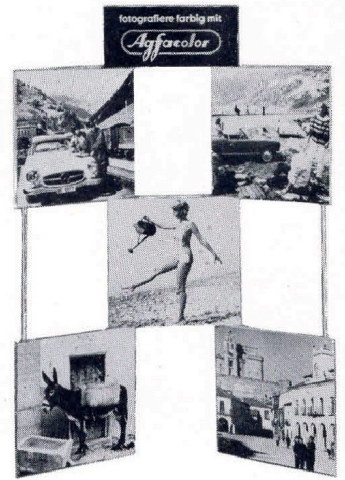
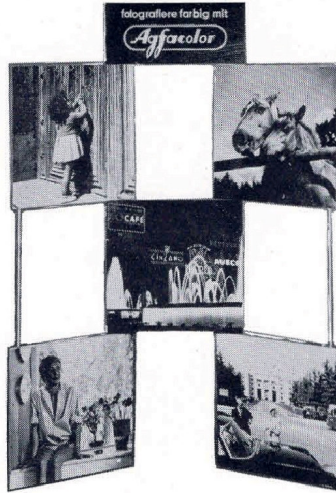

57-61 Agfa double face Panelrama, 5 color plates, printed on both sides, 10 1/2" x 10 1/2". no charge



300-61 Optima Step-Up Display for window or shelf. No charge

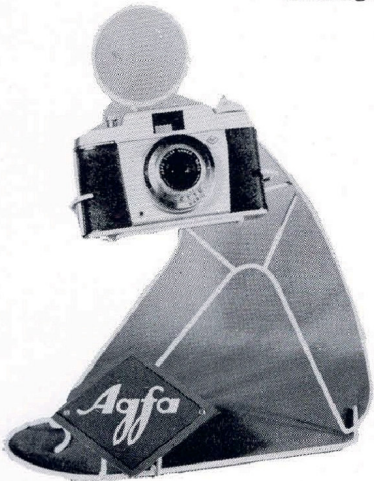

45-61 Agfa Man. Wire stand for 1 camera. \$1.00



Agfa Shirt available in
 No. 37/38/61 Small
 No. 39/40/61 Medium size
 No. 41/42/61 Large \$2.00



38/exp—61 Agfacolor Enlargement "Girl with hat," 16"x 24".
no charge



102/S—61 Agfacolor Enlargement "Girl under appletree," 24"x 31½".
no charge



100/S—61 Agfacolor Enlargement "Girl in window," 24"x 31½".
no charge



33/exp—61 Agfacolor Enlargement "Make up,"
no charge

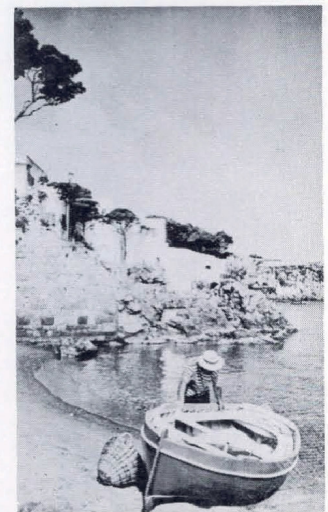

103/S—61 Agfacolor Enlargement "Porto Ischia," 24"x31½".
no charge

FILL OUT AND MAIL



CATALOG SUPPLEMENT

IMPORTANT CHANGES AND ADDITIONS TO AGFA DEALER PRICE CATALOG
FILE IN CATALOG UNTIL SUPERSEDED BY PERMANENT CATALOG PAGES.

NO. 6

NEW PRODUCTS

	<u>Net</u>	<u>List</u>
Agfachrome CT 18 135-20	(2-57)(50+2-44)	3.95
Agfachrome CT 18 135-36	(4-00)(50+3-80)	6.15
Agfachrome CT 18 120	(2-08)(50+1-98)	3.20
Agfachrome CT 18 127	(2-08)(50+1-98)	3.20
<u>Agfa Optima I Kit</u> - now shipped with NEW Agfachrome CT 18 135-20		
Contents: Camera		
Eveready Case		
Tully Flashgun with Case		
1 roll of Agfachrome CT 18 135-20		<u>Promotional</u> <u>List</u>
in Deluxe Gift Box (58-47)(3+55-54)	Value: \$96.80	89.95
<u>Agfa Optima IIS Kit</u>		
Contents: Camera		
Eveready Case		
Tully Flashgun with Case		
1 roll of Agfachrome CT 18 135-20		<u>Promotional</u> <u>List</u>
in Deluxe Gift Box (77-97)(3+74-07)	Value \$128.10	119.95
<u>Agfa Sonector 8 Zoom</u>		
8mm sound projector with microphone and speaker, Variomar f/1.6 15-25mm projection lens, 8 Volt 50 Watt projection lamp with built-in reflector.		<u>List</u>
<u>Net:</u> (268-20)		447.00

PRICE CHANGES: (effective date March 26, 1962)

<u>Item</u>	<u>New Net</u>	<u>New List</u>
Agfa 3mm Splicer	13.80	19.95
Agfa Varioscop 35/44 Enlarger	153.00	229.50

The following item is discontinued:
AGFAMETER Exposuremeter

June, 1962

COMPARATIVE LIST

Size		Competitive Regular Net*	AGFA Regular Net	Savings in \$\$ per Unit	% Lower than Competitive Net
<u>Single Weight</u>					
3 1/2x5	500	\$ 6.83	\$ 6.31	\$.52	7.6
5x7	25	.91	.85	.06	6.6
5x7	100	3.02	2.80	.22	7.3
5x7	500	12.74	11.80	.94	7.2
8x10	25	1.92	1.76	.16	8.3
8x10	100	6.60	6.11	.49	7.4
8x10	500	28.02	25.90	2.12	7.6
11x14	10	1.46	1.37	.09	6.2
11x14	50	6.37	5.88	.49	7.7
<u>Double Weight</u>					
5x7	25	1.17	1.11	.06	5.1
5x7	100	3.90	3.67	.23	5.9
5x7	500	16.48	15.44	1.04	6.3
8x10	25	2.47	2.31	.16	6.5
8x10	100	8.55	8.00	.55	6.4
8x10	250	18.66	17.49	1.17	6.3
11x14	10	1.89	1.79	.10	5.3
11x14	50	8.22	7.70	.52	6.3
14x17	10	2.89	2.73	.16	5.5
14x17	50	12.58	11.77	.81	6.4
16x20	10	3.87	3.61	.26	6.7
16x20	50	16.77	15.70	1.07	6.3

*Competitor's Basic Net Price



CATALOG SUPPLEMENT NO. 3

IMPORTANT CHANGES AND ADDITIONS TO AGFA DEALER PRICE CATALOG
FILE IN CATALOG UNTIL SUPERSEDED BY PERMANENT CATALOG PAGES.

NEW, NEW, NEW,

<u>Item</u>	<u>List</u>	<u>Net</u>
<u>Positive Film S Sheet Film</u>		
4 x 5" 25-sheets	\$ 4.00	\$ 2.60
5 x 7" 25-sheets	6.75	4.39
8 x10" 25-sheets	11.85	9.65

<u>Item</u>	<u>List</u>	<u>Net</u>
<u>Slide Mounts Type K, box of 20</u>	\$ 2.25	
		1 - 2 \$ 1.50
		3 -11 1.35
		12 or more 1.13

PRICE CHANGE (effective date January 29, 1962)

<u>Item</u>	<u>List</u>	<u>Net</u>
Agfa Binocular 10 x 40 } with case	\$ 79.95	\$ 47.97
Agfa Binocular 8 x 30 }	59.95	35.97

PLEASE NOTE:

The price of Agfa papers HAS NOT INCREASED!

Push Agfa paper for GREATER PROFIT!

Compare the low Agfa NET prices.

Agfa papers give you BLACKER BLACKS

..... WHITER WHITES

and now

MORE PROFIT PER SALE

January 19, 1962



CATALOG SUPPLEMENT

IMPORTANT CHANGES AND ADDITIONS TO AGFA DEALER PRICE CATALOG
FILE IN CATALOG UNTIL SUPERSEDED BY PERMANENT CATALOG PAGES.

NO. 4

The following items are discontinued:

Agfa Optima 2200

Agfa Super Silette LK

Agfa Super Silette Automatic

Agfa Silette Vario and Silette Vario Kit

Agfaflex I

Agfaflex II

Agfa Reflex (Flexilette)

Agfa Ambi Silette

Agfa Movex Automatic

Agfa Diamator S

Agfa Slide Mounts Type W

Agfa Rondix 35

Most accessories remain available except for Movex Automatic.

February 8, 1962



CATALOG SUPPLEMENT NO.

IMPORTANT CHANGES AND ADDITIONS TO AGFA DEALER PRICE CATALOG
FILE IN CATALOG UNTIL SUPERSEDED BY PERMANENT CATALOG PAGES.

5

NEW PRODUCTS

Agfa Selecta Camera	(2204/263 64-97) (3+61-72)	\$ 99.95
Case for Agfa Selecta	(6118/000 9-91) (3+ 9-42)	15.25
Agfa Selecta-M Camera	(2220/249 128-70)	198.00
Case for Agfa Selecta-M	(6115/000 10-73)	16.50
Agfa Silette I Camera	(2605/276 19-97) (3+18-49 12+16-17)	29.95
Case for Agfa Silette I	(6114/0000 4-88) (3+ 4-63 12+ 4-05)	7.50
Agfa Silette L Camera	(2609/276 32-47) (3+30-84 12+26-97)	49.95
Case for Agfa Silette L	(6114/0000 4-88) (3+ 4-63 12+ 4-05)	7.50
Agfa Clack Camera	(0620/000 6-63) (6+5 -97 12+ 4-97)	9.95
Case for Clack	(6042/000 1- 97) (6+1 -77 12+ 1 -47)	2.95
Agfa Tully Flashgun Type K with case	(6836/0001 5- 82) (10+4-83)	8.95
Isi Flashgun with case	(6830/0001 3-87) (3+3-67 12+3-21)	5.95

Please correct the following prices in the Dealer Price Catalog on page 22
(July, 61)

Brovira - Double Weight 14 x 17 50 sheet should read	\$ 11.77
Brovira - Double Weight 16 x 20 50 sheet should read	\$ 15.70

April 15, 1962